

Features

- 2:1 Wide Input Voltage Range
- 40 Watts Output Power
- 1.6kVDC Isolation
- UL Certified
- Fixed Operating Frequency
- Six-Sided Continuous Shield
- Design Meet Safety Standard
- Standard 50.8 x50.8x10.2mm Package
- Efficiency to 90 %

Rev. 1

Description

The RP40-G series DC/DC converters are certified to UL 60950-1 and to cUL 60950-1. This makes them ideal for all telecom and industrial applications where approved safety standards are required. The industry standard 2" x 2" package meets military standards for thermal shock and vibration tolerance.

Selection Guide Single and Dual Outputs

Part Number	Input Range VDC	Output Voltage VDC	Output Current mA	Input ⁽⁴⁾ Current mA	Efficiency ⁽⁵⁾ %	Capacitive ⁽⁶⁾ Load max.
RP40-123.3SG	9-18	3.3	8000	2750	84	21000µF
RP40-1205SG	9-18	5	8000	4065	86	13600µF
RP40-1212SG	9-18	12	3333	4065	86	2360µF
RP40-1215SG	9-18	15	2666	4015	87	1510µF
RP40-243.3SG	18-36	3.3	8000	1325	87	21000µF
RP40-2405SG	18-36	5	8000	1961	89	13600µF
RP40-2412SG	18-36	12	3333	2048	88	2360µF
RP40-2415SG	18-36	15	2666	1985	89	1510µF
RP40-483.3SG	36-75	3.3	8000	655	88	21000µF
RP40-4805SG	36-75	5	8000	969	90	13600µF
RP40-4812SG	36-75	12	3333	1000	89	2360µF
RP40-4815SG	36-75	15	2666	992	89	1510µF
RP40-1212DG	9-18	±12	±1800	4444	85	±1200µF
RP40-1215DG	9-18	±15	±1400	4321	85	±750µF
RP40-2412DG	18-36	±12	±1800	2169	87	±1200µF
RP40-2415DG	18-36	±15	±1400	2108	87	±750µF
RP40-4812DG	36-75	±12	±1800	1084	87	±1200µF
RP40-4815DG	36-75	±15	±1400	1054	87	±750µF
RP40-120512TG	9-18	5 / ±12	6000 / ±400	4024	86	6800µF/±330µF
RP40-120515TG	9-18	5 / ±15	6000 / ±300	3963	86	6800µF/±110µF
RP40-240512TG	18-36	5 / ±12	6000 / ±400	1989	87	6800µF/±330µF
RP40-240515TG	18-36	5 / ±15	6000 / ±300	1958	87	6800µF/±110µF
RP40-480512TG	36-75	5 / ±12	6000 / ±400	982	88	6800µF/±330µF
RP40-480515TG	36-75	5 / ±15	6000 / ±300	967	88	6800µF/±110µF

* no suffix for CTRL function with Positive Logic (1=ON, 0=OFF), this is standard

* add suffix **-HC** for premounted heatsink and clips

Ordering Examples

RP40-2405SG = 24V Input, 5V Output, Positive Logic CTRL pin.

RP20-4812DG-HC = 48V Input, ±12V Output, Positive Logic CTRL pin, Heatsink fitted

RP20-120512TG-HC = 24V Input, 5V and ±12V Outputs, Positive Logic CTRL pin, Heatsink fitted

Derating graphs are valid only for the shown part numbers. If you need detailed derating information about a part-number not shown here please contact our technical support service at info@recom-development.at

POWERLINE

DC/DC-Converter

RP40-S_D_TG Series

40 Watt Single, Dual, Positive Dual & Triple Output

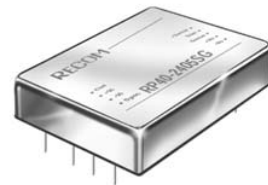

UL-60950-1 Certified

RECOM

Derating-Graph (Ambient Temperature)

RP40-4805SG

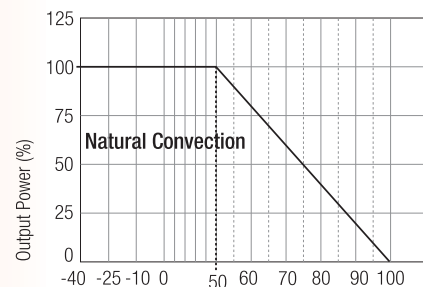

Ambient Temperature Range (°C)

Typical Characteristics

RP40-4805SG

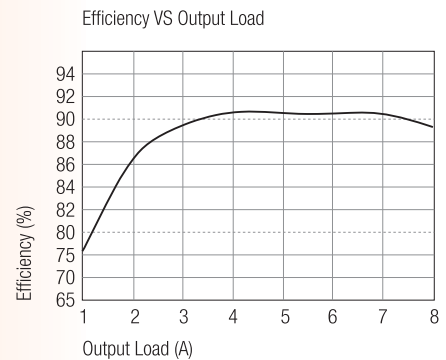
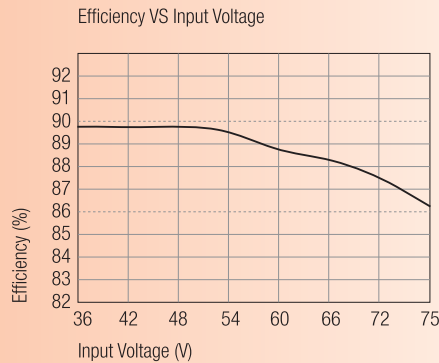

Specifications (typical at nominal input and 25°C unless otherwise noted)

Input Voltage Range	12V nominal input	9-18VDC	
	24V nominal input	18-36VDC	
	48V nominal input	36-75VDC	
Under Voltage Lockout	12V input	DC-DC ON	9VDC
		DC-DC OFF	8VDC
	24V input	DC-DC ON	17.8VDC
		DC-DC OFF	16VDC
	48V input	DC-DC ON	36VDC
		DC-DC OFF	34VDC
Input Filter (see Note 13)		L-C Type	
Input Voltage Variation dv/dt	(Complies with ETS300 132 part 4.4)	5V/ms max	
Input Surge Voltage (100 ms max.)	12V Input	36VDC	
	24V Input	50VDC	
	48V Input	100VDC	
Input Reflected Ripple (nominal Vin and full load see Note 3)		40mA _{p-p}	
Start Up Time (nominal Vin and constant resistor load)		25ms typ.	
Remote ON/OFF (see Note 7) (Positive logic)	DC-DC ON	Open or 3.5V < Vr < 12V	
	DC-DC OFF	Short or 0V < Vr < 1.2V	
	Nominal input	2.5mA	
Remote OFF input current		2.5mA	
Output Power		40W max.	
Output Voltage Accuracy (full Load and nominal Vin)	Single & Dual	±1%	
	Triple Main	±1%	
	Auxiliary	±5%	
Voltage Adjustability		±10%	
Minimum Load	Single and Dual Positive	0%	
	Dual and Triple	10% of full load	
Line Regulation (low line, high line at full load)	Single & Dual	±0.5%	
	Triple Main	±1%	
	Triple Auxiliary	±5%	
Load Regulation (10% to 100% full load see Note 9 and 10)	Single	±0.5%	
	Dual	±1%	
	Triple Main	±2%	
	Auxiliary	±5%	
Cross Regulation (Note 11)	Triple Main	±1%	
	Dual / Triple Auxiliary	±5%	

continued on next page

Specifications (typical at nominal input and 25°C unless otherwise noted)

Ripple and Noise (20MHz bandwidth) (Measured with a 1004pF/50V MLCC)	Single 3.3, 5V Single 12, 15V Dual 12V Dual 15V RP40-xxxxxTG	50mVp-p 75mVp-p 120mVp-p 150mVp-p 50 / 75mVp-p
(see Note 12)		
Temperature Coefficient		±0.02%/°C max.
Transient Response (25% load step change)		300µs
Over Voltage Protection	3.3V	3.9V
Zener diode clamp (only single)	5V 12V 15V	6.2V 15V 18V
Over Load Protection (% of full load at nominal Vin)		150% max
Undervoltage Lockout		See Application Notes
Short Circuit Protection		Hiccup, automatic recovery
Efficiency		see „Selection Guide“ table
Isolation Voltage		1600VDC min.
Isolation Resistance		1 GΩ min.
Isolation Capacitance		1000pF max.
Operating Frequency (see Note 14)		300kHz typ.
Approved to Safety Standards	Single, Triple Dual	UL 1950, EN60950 EN60950
Operating Temperature Range		-40°C to +85°C(with derating)
Maximum Case Temperature		100°C
Storage Temperature Range		-55°C to +105°C
Thermal Impedance (see Note 8)	Natural convection Heat Sink with 20LFM Heat Sink with 500LFM	9.2°C/Watt 8.5°C/Watt 2.8°C/Watt
Thermal Shock		MIL-STD-810D
Vibration		10-55Hz, 10G, 30 Min. along X, Y and Z
Relative Humidity		5% to 95% RH
Case Material		Nickel plated copper
Base Material		Non-conductive black plastic FR4
Potting Material		Epoxy (UL94-V0)
Conducted Emissions (see Note 16)	EN55022	Level A
Radiated Emissions	EN55022	Level A
ESD	EN61000-4-2	Perf. Criteria 2
Radiated Immunity	EN61000-4-3	Perf. Criteria 2
Fast Transient	EN61000-4-4	Perf. Criteria 2
Surge	EN61000-4-5	Perf. Criteria 2
Conducted Immunity	EN61000-4-6	Perf. Criteria 2
Weight		60g
Dimensions		50.8 x 50.8 x 10.2mm
MTBF (see Note 2)		1398 x 10 ³ hours

Package Style and Pinning (mm)

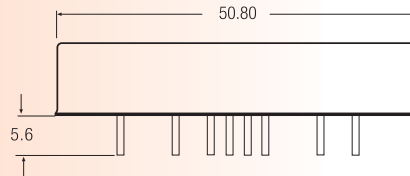
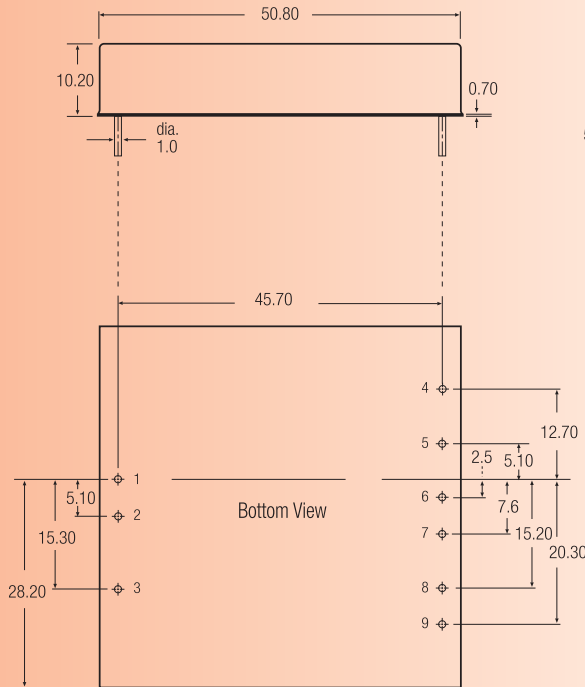

Pin Connections

Pin #	Single	Dual	Triple
1	+Vin	+Vin	+Vin
2	-Vin	-Vin	-Vin
3	CTRL	CTRL	CTRL
4	NC	No Pin	+Aux
5	-Sense (Note1)	+Vout	Com
6	+Sense (Note1)	Com	-Aux
7	+Vout	Com	+Vout
8	-Vout	-Vout	-Vout(Com)
9	Trim	Trim	NC

NC = No Connection

Pin Pitch Tolerance ± 0.35 mm

Output can be externally trimmed by using the method shown below. () for dual output trim. See Application Notes for more details

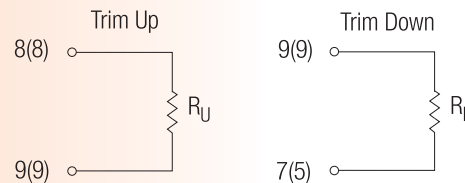

Notes :

- Maximum output deviation is 10% inclusive of remote sense and trim. If remote sense is not being used, the +Vsense should be connected to its corresponding +OUTPUT and likewise the sense should be connected to its corresponding -OUTPUT
- BELLCORE TR-NWT-000332. Case I: 50% Stress, Temperature at 40°C (Ground fixed and controlled environment).
- Simulated source impedance of 12μH. 12μH inductor in series with +Vin.
- Maximum value at nominal input voltage and full load of standard type.
- Typical value at nominal input voltage and full load.
- Test by minimum Vin and constant resistor load.
- The ON/OFF control pin voltage is referenced to negative input.
- Heat sink is optional and P/N: 7G-0026A. Powerline DC/DC Converters can be ordered with pre-mounted heatsinks including antivibration fixing clips (add suffix -HC). See Application Notes for heatsink details.
- The triple output required a minimum 10% loading on the output to maintain specified regulation. Operation under no-load condition will not damage these devices, however they may not meet all listed specification.
- Load regulation for triple output: Main output(V1):10 to 100% with 10% to 100% balanced on auxiliaries. Auxiliary outputs(V2 and V3):10% to 100% balanced on all outputs.
- Cross regulation for triple output: Main output 100% load, auxiliary 100%, other auxiliary 25% to 100%. Auxiliary outputs(V2 and V3):main output 100% load, auxiliary 100%, other auxiliary 25% to 100% or main output 25%, auxiliary 25%, other auxiliary 25% to 100%.
- The models of RP40-XX3.305DG are specified with a 1uF ceramic output capacitors.
- An external filter capacitor is required for normal operation. The capacitor should be capable of handling 1A ripple current for 48V/24V models. RECOM suggest: Nippon chemi-con KMF series, 220μF/100V, ESR 90m Ω.
- Operating frequency for dual output: master (5Vo) 300KHz slave (3.3Vo) 500KHz.
- Any condition of dual output (3.3V/5V) rated lout current, not to exceed 8A of total output currents. The product safety approval pending.
- See application notes for EMI-filtering.