

3M

740 Wrist strap + shoe tester

Operating Instructions

MO 0765-0601
April, 2001

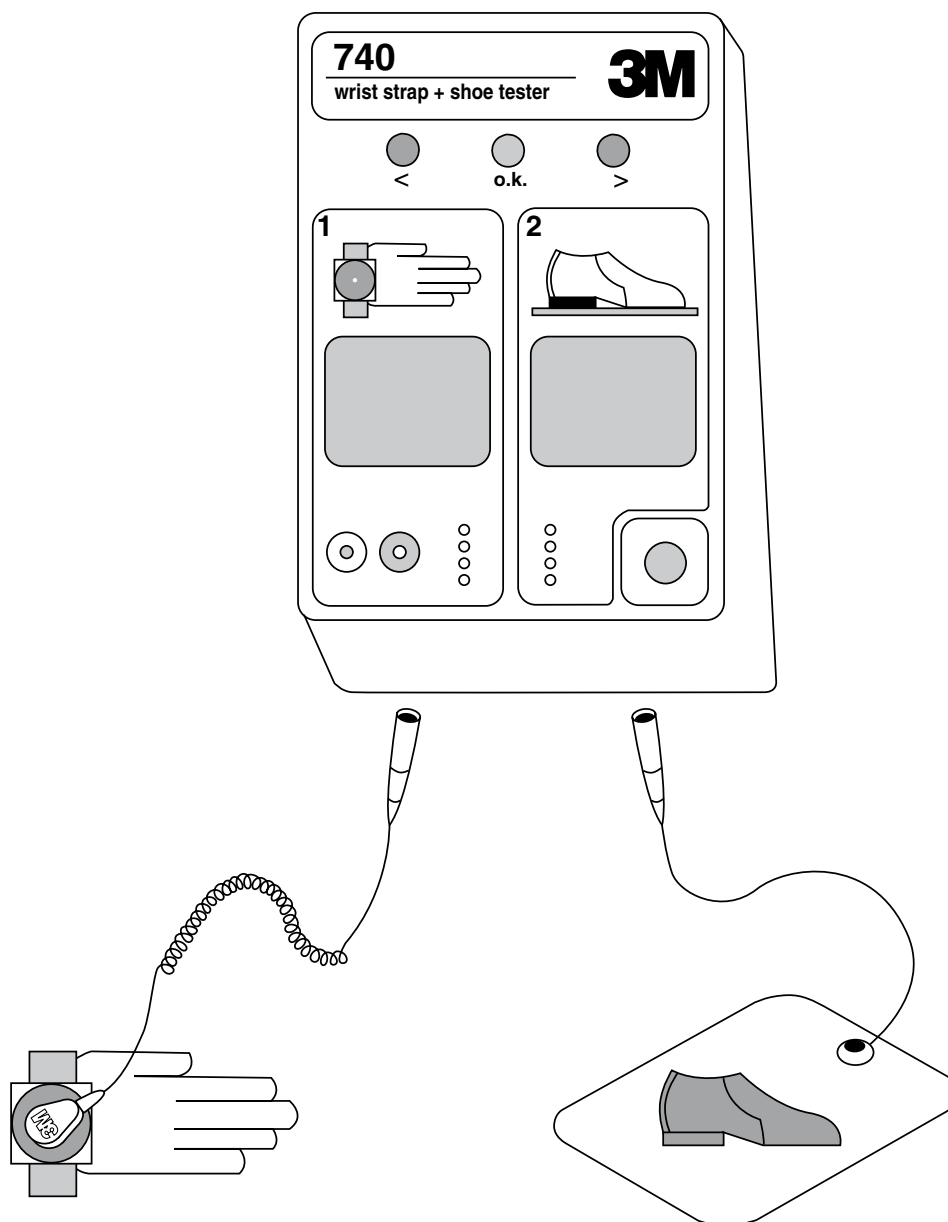

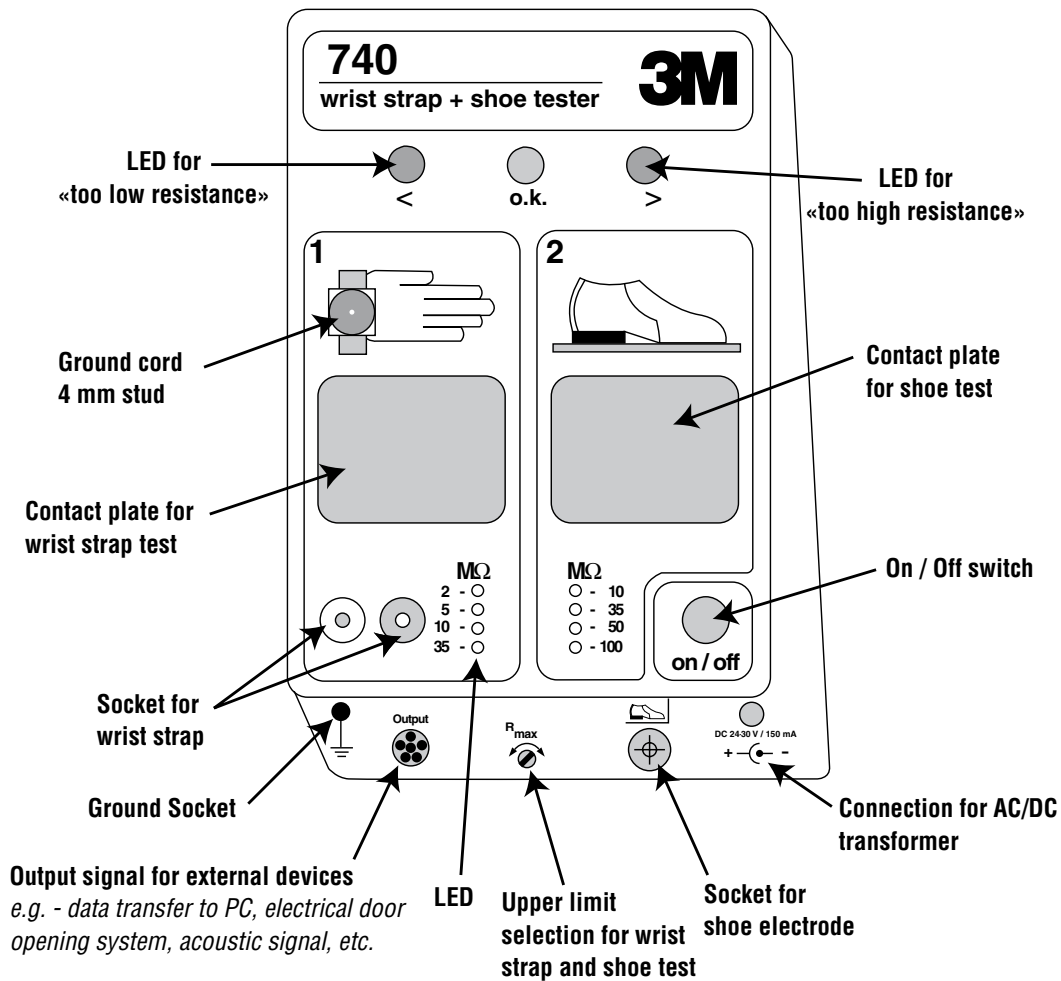

I. General

Personnel grounding devices such as wrist straps and conductive footwear are the primary method to minimize charge generation on the human body. They must be able to drain this charge as rapidly as it is generated.

For this reason, it is important to test wrist straps and conductive footwear on a regular basis to ensure they are functioning properly and that the test results can be recorded

II. Declaration of Conformity

The 740 Wrist Strap and Shoe Tester is in conformity with the regulations of the EMC-directive 89/336/EEG. The following standards have been taken into account while designing and manufacturing the instrument:

EN 60204-1/85,
EN 60204-1/91,
EN 61010 (Safety),
EN 50082-1/92 and
EN 50082-2/92.

III. Description

The 740 wrist strap and shoe tester is an electronic test instrument which is easy to operate and designed to be wall mounted. An AC/DC transformer is supplied. The 740 switches off automatically after non-use for approximately 30 minutes.

The unit consists of two measurement circuits with an open circuit test voltage of 20 V for wrist strap and shoe test applications. For wrist strap and footwear testing, a minimum threshold resistance of 750 k Ω is set internally. The desired maximum allowable resistance level can be selected separately for each measurement. If the resistance of the tested wrist strap or footwear is within the selected range, the green "o.k." LED will illuminate. The red "<" LED alerts the operator that the resistance of the tested device is under 750 k Ω . The red ">" LED indicates that the selected maximum resistance is exceeded.

The 740 can be connected to external devices such as computers (for data recording), electrical door opening systems, counter or other evaluating components.

The 740 wrist strap and shoe tester consists of:

- Instruction manual with daily log sheet
- Base unit
- Data output connector plug
- Wall mounting kit, 3M Dual Lock™ fastening system and template
- Cover for wrist strap plug-in jack
- AC/DC transformer
- Ground cord

Accessories:

- Shoe electrode type 741 (single electrode) sold separately

IV. Operation

Connect the AC/DC transformer (DC 24-30 V, 150 mA) to the 740 tester.

Note: If you notice a delay in the response time of the LED illumination please connect the ground cord supplied to the ground socket of the 740.

Please ensure proper earth ground connection!

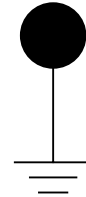

Switch the unit on. All LEDs will flash for approximately 1 s to check their function. Select the desired upper maximum resistance level for both the wrist strap and shoe test by using a small screw driver.



The 741 shoe electrode must be connected if footwear testing is required.

V. Wall Mounting

The enclosed 3M Dual Lock™ fastening discs must be screwed to the wall using the attached template approximately 1,500mm (5 feet) above the floor. Drill three holes of 5 mm (0.2 in) diameter at marked locations. Make sure the area on the 740 in which the Dual Lock™ fastening strips are placed is free of dust and dirt. Attach the 3M Dual Lock™ fastening strips to the rear of the 740 tester to the bottom and top in parallel; see drawing for locations.

For securing on the wall, press the 740 firmly against the discs. For removal of the 740, lift the top corners with both hands.

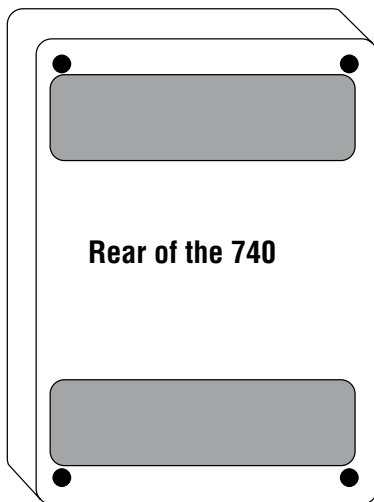

Template

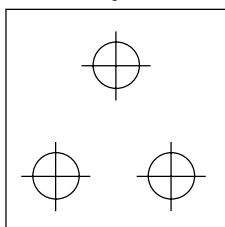

5 feet
(1 500 mm)

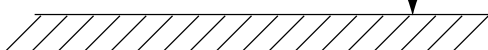

VI. Wrist Strap Test

Put the wrist band on with ground cord attached and insert the ground cord into the wrist strap plug-in jack. Depress the metal contact plate and hold it. One of the indicator LEDs will illuminate.

An illuminated green LED indicates that the wrist strap performs within the resistance range of 750 k Ω to the upper selected value of 2, 5, 10 or 35 M Ω . If a red "<" LED is illuminated, the current limiting resistor in the ground cord is bypassed and the cord has to be replaced. The red ">" LED indicates that the selected resistance range is exceeded. Check to see if the high resistance is in the cord, the wrist band or in the contact between wrist band and the operator's skin. To check the resistance of the ground cord, leave the plug end of the ground cord attached to the tester and disconnect the snap end from the wrist band. Connect ground cord snap to the stud in the hand symbol or press it onto the contact plate and depress the plate until one of the LEDs is illuminated.

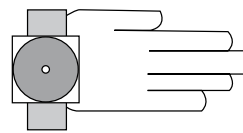

If the green LED illuminates now, the ground cord can be used.

If the red ">" LED is illuminated, replace the ground cord.

In some cases, high contact resistance between the skin and wrist band will cause the tester to show a red ">" LED condition. This resistance may be caused by dry skin or the presence of hair in the wrist area. The use of a skin lotion is recommended to solve this problem. If a red ">" LED condition still exists, replace the wrist band.

Note: The use of skin lotions are not recommended for use with the 3M™ 4600 Series Thermoplastic Wrist Bands.

VII. Shoe test

The 741 shoe electrode has to be connected to the 740 shoe jack.

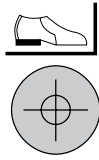

Switch the 740 on. Stand on the 741 shoe electrode. If you are using shoe straps with $1\text{ M}\Omega$ resistor on both feet to be tested with the 741 shoe electrode, you have to test the straps one after the other, to avoid a red "<" indication. Care must be taken not to put the non-tested foot on an ESD-protective flooring to avoid a bypass to ground. Depress the metal contact plate in the shoe test area until one of the indicator LEDs is on. The green LED indicates that the resistance of the person through the footwear is in the range between $750\text{ k}\Omega$ and the desired upper maximum level ($10, 35, 50$ or $100\text{ M}\Omega$). If the red ">" LED is illuminated, clean the soles of the shoes or check shoe grounding system (heel ground or toe ground strap) and retest. If, after cleaning, the red ">" LED remains on, replace appropriate device. If the red "<" LED is illuminated, the minimum resistance of the shoes or shoe grounding system is below $750\text{ k}\Omega$.

Note: Some types of shoe grounding systems are manufactured with a resistance of less than $750\text{ k}\Omega$. These types of systems are used in various industries such as handling of explosives or when grounding of personnel through wrist straps is not practical. Shoe grounding systems with a less than $1\text{ M}\Omega$ resistance will indicate with the red "<" LED indication on the 740.

The shoe test does not influence the wrist strap test, therefore the shoes can be tested while the wrist strap is still connected to the 740 or the wrist strap can be tested while the operator is standing on the 741 shoe electrode. Both metal plates should not be pressed at the same time.

VIII. Data Output Connector

If you are going to use the data output connector you must follow a test sequence. It must be wrist strap test first and then the shoe test. **If this sequence is not strictly kept, the output at the pins described on page 7 will be altered.**

The 740 will provide digital signals (high/low) while testing the personnel grounding devices. These digital signals can be used for data recording (Example 1) and authorization control equipment such as electrical door opening systems (Example 2). The output of the 740 will give you permanently +5 V at pin 3 and DC-return at pin 6. The remaining pins 1, 2, 4 and 5 (open collector) will be high (max. +30 V / 20 mA have to be provided externally) or low (DC-return) while pressing on the contact plates either for wrist strap or shoe tests. The chart on page 7 shows all of the possible test results and the corresponding output levels.

Example 1: Output connection for use with a computer

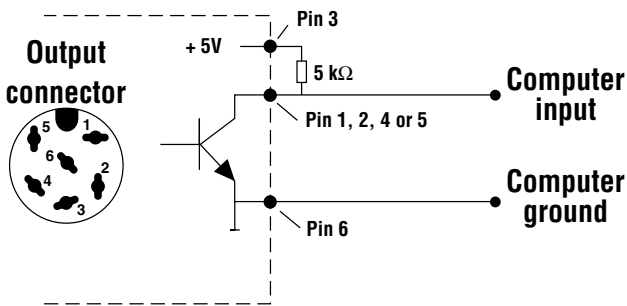

Example 2: Output connection for use with a controlling device

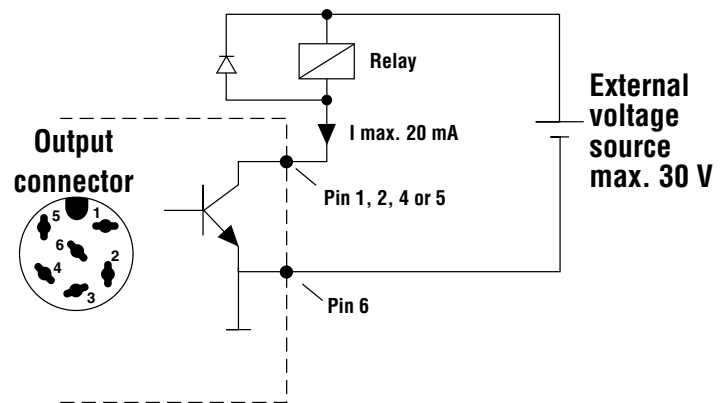

Data output connector pin status when testing wrist strap/shoe

	Power up:	Test result 1:		Test result 2:		Test result 3:		Test result 4:	
		wrist wrap o.k.	shoe o.k.	wrist wrap not o.k.	shoe o.k.	wrist wrap o.k.	shoe not o.k.	wrist wrap not o.k.	shoe not o.k.
pin 1	hi	hi	hi	lo	hi	hi	lo	lo	lo
pin 2	hi	hi	hi	hi	lo	hi	lo	hi	lo
pin 3	hi	hi	hi	hi	hi	hi	hi	hi	hi
pin 4	hi	hi	lo	hi	hi	hi	hi	hi	hi
pin 5	hi	lo	lo	hi	lo	lo	hi	hi	hi

The sequence for testing must be wrist strap test first and then the shoe test.

 Shaded pin indicators will read "hi" if the sequence is reversed or only the shoe tests are performed.

Data Output Connector

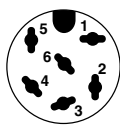

- pin 1, 2, 4, 5 - high or low
- pin 3 - + 5 V
- pin 6 - DC-return

IX. Specifications

Dimension of base unit:

138 mm x 190 mm x 53 mm
(5.25 x 7.5 x 2) inches

Weight:

450 g
(15.75 oz)

Power supply:

external AC/DC transformer,
DC 24-30 V / 150 mA

Accuracy:

±10% of 2, 5, 10, 35 and 50 MΩ-ranges
±20% of 100 MΩ-range

Output:

open collector at pin 1, 2, 4, 5
(max. +30 V / 20 mA)
DC-return at pin 6, +5 V at pin 3

Measurement voltage:

DC (20±1) V (open circuit)

X. Verification Procedure

The following procedure can be used to determine if the 740 operates within its specifications.

Please note: The tester has no adjustable components.

Equipment needed:

1. resistors
750 k Ω - 120 M Ω , tolerance $\pm 1\%$
2. 2 wires
as required to connect the reference resistor

Verification of wrist strap test circuit:

Connect the reference resistor to the 740 as shown in the Figure 1. Switch the 740 unit on. Select the 2 M Ω range and use the reference resistors as indicated in the test table and press contact plate A.

The LEDs will indicate as shown below if the 740 performs within specifications. Repeat this procedure for 5, 10 and 35 M Ω ranges.

Reference resistor	Resistance range settings	LED - Indication
*750 k Ω	2 M Ω - range	Red
900 k Ω		Green
1.8 M Ω		Green
>2.2 M Ω		Red
4.5 M Ω	5 M Ω - range	Green
>5.5 M Ω		Red
9.0 M Ω	10 M Ω - range	Green
>11.0 M Ω		Red
31.5 M Ω	35 M Ω - range	Green
>38.5 M Ω		Red

**This example is used above*

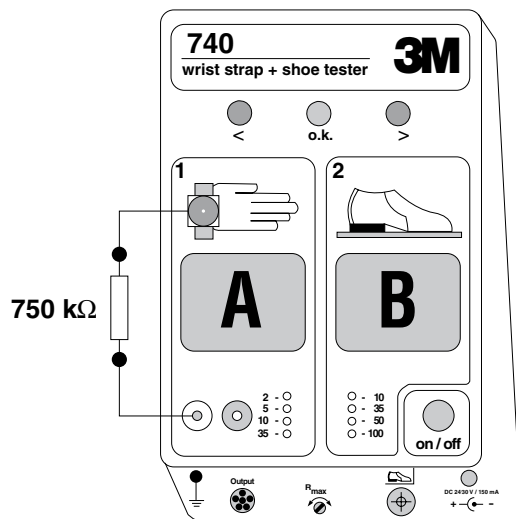

Figure 1

Verification of shoe test circuit:

Connect the reference resistor to the 740 as shown in Figure 2. Select the 10 MΩ range using the reference resistors indicated in the test table and press contact plate B.

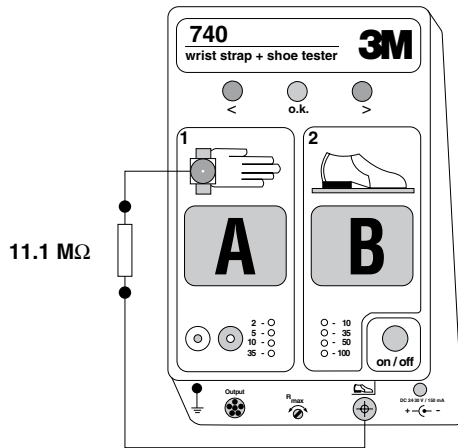

Figure 2

The LEDs will indicate as shown below. Repeat this procedure for 35, 50 and 100 MΩ ranges.

Reference resistor	Resistance range settings	LED - Indication
750 kΩ	10 MΩ - range	Red
900 kΩ		Green
9.0 MΩ		Green
*>11.0 MΩ		Red
31.5 MΩ	35 MΩ - range	Green
>38.5 MΩ		Red
45.0 MΩ	50 MΩ - range	Green
>55.0 MΩ		Red
80.0 MΩ	100 MΩ - range	Green
>120.0 MΩ		Red

**This example is used above*

3M 740 Wrist Strap + Shoe Tester Logbook

Name	Month / Year																															
	1	2	3	4	5	6	7	8	9	10	11	12	13	14	15	16	17	18	19	20	21	22	23	24	25	26	27	28	29	30	31	
	W	S	W	S	W	S	W	S	W	S	W	S	W	S	W	S	W	S	W	S	W	S	W	S	W	S	W	S	W	S	W	S
Test 1																																
Test 2																																
Test 1																																
Test 2																																
Test 1																																
Test 2																																
Test 1																																
Test 2																																
Test 1																																
Test 2																																
Test 1																																
Test 2																																
Test 1																																
Test 2																																
Test 1																																
Test 2																																
Test 1																																
Test 2																																
Test 1																																
Test 2																																
Test 1																																
Test 2																																
Test 1																																
Test 2																																

Example:

Not ok:

ok:

Name	Month / Year			
	1	2	3	4
	W	S	W	S
Test 1	X	X	X	X
Test 2	X	X	X	X

Test parameters:

Wrist Strap (W) *Shoes (S)*

750 kΩ to: 2 MΩ 750 kΩ to: 10 MΩ

5 MΩ 35 MΩ

10 MΩ 50 MΩ

35 MΩ 100 MΩ

Unit calibrated on:

By:

Next calibration on:

Serial number:

Important Notice: Before using this product, you must evaluate it and determine if it is suitable for your intended application. You assume all risks and liability associated with such use. **Warranty: Limited Remedy: Limited Liability.** This product will be free from defects in material and manufacture as of the date of purchase. 3M MAKES NO OTHER WARRANTIES INCLUDING, BUT NOT LIMITED TO, ANY IMPLIED WARRANTY OF MERCHANTABILITY OR FITNESS FOR A PARTICULAR PURPOSE. If this product is defective within the warranty period stated above, your exclusive remedy shall be, at 3M's option, to replace or repair the 3M product or refund the purchase price of the 3M product. Except where prohibited by law, 3M will not be liable for any loss or damage arising from this 3M product, whether direct, indirect, special, incidental or consequential regardless of the legal theory asserted. Litho in USA - Recycled paper - 40% pre-consumer waste paper.



Electronic Handling & Protection Division

6801 River Place Blvd.
Austin, Tx 78726 - 9000

MO 0765-0601