

2-Wire AC & AC/DC 18 mm Diameter Inductive Sensors

- 5 to 15 mm sensing ranges
- 18 mm threaded barrels
- LED power and output indication
- Cable and quick disconnect models

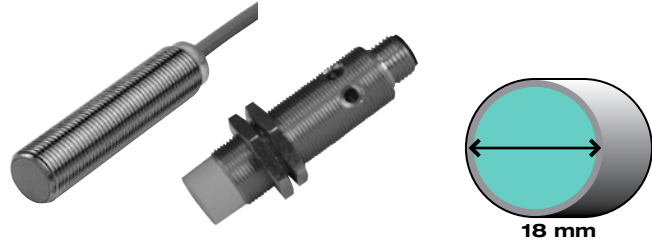

Technical Specifications

SUPPLY VOLTAGE	Suffix WS, WO	20-250 VAC
	Suffix US	20-250 VAC/300 VDC
SUPPLY FREQUENCY		45-65 Hz
LOAD CURRENT (I _L)	Suffix WS, WO	5-200 mA max.
	Suffix US	4-300 mA max.
LEAKAGE CURRENT (OFF-STATE)	Suffix WS, WO	≤ 1.7 mA
	Suffix US	≤ 0.8 mA
OUTPUT	Suffix WS, US	Normally open
	Suffix WO	Normally closed
VOLTAGE DROP AT I _L (MAX.)		≤ 8 V
INRUSH CURRENT		< 1.7 A/20 ms
HYSTERESIS		3-15% (5% typical)
SHORT CIRCUIT AND OVERLOAD PROTECTION	Suffix WS, WO	No
	Suffix US	Yes
REVERSE POLARITY PROTECTED		Yes
LED INDICATION		See dimension drawings
SENSING FACE MATERIAL		PBT
STANDARDS		EN 60947-5-2
ENVIRONMENTAL PROTECTION		IP67
AMBIENT TEMPERATURE		-13 °F to +158 °F (-25 °C to +70 °C)
APPROVALS		



See pages 803-854 for cordsets



See pages 865-872 for accessories

Wiring Diagrams

2-Wire AC



Cable Connection

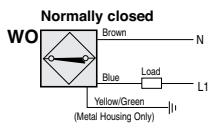
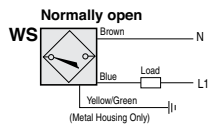

Quick Disconnect

Note: Wiring diagrams show quick disconnect pin numbers.

V11 Type

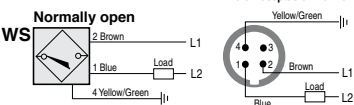

Quick Disconnect

Note: Wiring diagrams show quick disconnect pin numbers.

V12 Type

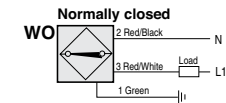
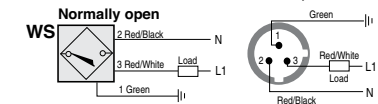

V93 Type

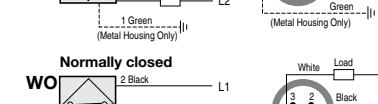
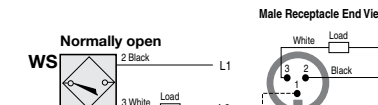

2-Wire AC/DC



Cable Connection

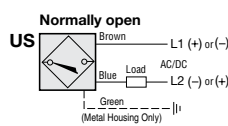

Quick Disconnect

Note: Wiring diagrams show quick disconnect pin numbers.

V12 Type



V93 Type

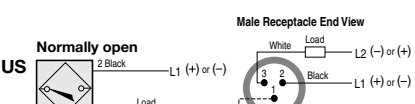

18 mm Diameter

2-Meter Cable Models

Dia. (mm)	Model Number	Range (mm)	Mounting	Electrical Output	Switching Frequency	Barrel Material*	Cable Jacket/Size	Dwg. No.
18	NBB5-18GM60-WS ⚡	5	Flush	Normally open	25 Hz	Ni-Brass	PVC/#22 AWG	1
	NBB5-18GM60-WO ⚡	5	Flush	Normally closed	25 Hz	Ni-Brass	PVC/#22 AWG	1
	NBN8-18GM60-WS ⚡	8	Nonflush	Normally open	25 Hz	Ni-Brass	PVC/#22 AWG	2
	NBN8-18GM60-WO ⚡	8	Nonflush	Normally closed	25 Hz	Ni-Brass	PVC/#22 AWG	2
	NBB8-18GM60-US ⚡	8	Flush	Normally open	30 Hz	Ni-Brass	PUR/#20 AWG	3
	NBN15-18GM60-US ⚡	15	Nonflush	Normally open	30 Hz	Ni-Brass	PUR/#20 AWG	4



Micro AC (M12) Quick Disconnect Models

Dia. (mm)	Model Number	Range (mm)	Mounting	Electrical Output	Switching Frequency	Barrel Material*	Quick Disconnect	Dwg. No.
18	NBB5-18GM60-WS-V11 ⚡	5	Flush	Normally open	25 Hz	Ni-Brass	M12 Micro AC	5
	NBN8-18GM60-WS-V11 ⚡	8	Nonflush	Normally open	20 Hz	Ni-Brass	M12 Micro AC	6



Micro AC (1/2"-20) Quick Disconnect Models

Dia. (mm)	Model Number	Range (mm)	Mounting	Electrical Output	Switching Frequency	Barrel Material*	Quick Disconnect	Dwg. No.
18	NBB5-18GM60-WS-V12 ⚡	5	Flush	Normally open	20 Hz	Ni-Brass	1/2"-20 Micro AC	7
	NBB5-18GM60-WO-V12 ⚡	5	Flush	Normally closed	20 Hz	Ni-Brass	1/2"-20 Micro AC	7
	NBN8-18GM60-WS-V12 ⚡	8	Nonflush	Normally open	25 Hz	Ni-Brass	1/2"-20 Micro AC	8
	NBB8-18GM60-US-V12 ⚡	8	Flush	Normally open	30 Hz.	Ni-Brass	1/2"-20 Micro AC	9
	NBN15-18GM60-US-V12 ⚡	15	Nonflush	Normally open	30 Hz.	Ni-Brass	1/2"-20 Micro AC	10



Mini AC/DC (7/8"-16) Quick Disconnect Models

Dia. (mm)	Model Number	Range (mm)	Mounting	Electrical Output	Switching Frequency	Barrel Material*	Quick Disconnect	Dwg. No.
18	NBB5-18GM80-WS-V93 ⚡	5	Flush	Normally open	25 Hz	Ni-Brass	7/8"-16 Mini AC	11
	NBB5-18GM80-WO-V93 ⚡	5	Flush	Normally closed	25 Hz	Ni-Brass	7/8"-16 Mini AC	11
	NBN8-18GM80-WS-V93 ⚡	8	Nonflush	Normally open	25 Hz	Ni-Brass	7/8"-16 Mini AC	12
	NBN8-18GM80-WO-V93 ⚡	8	Nonflush	Normally closed	25 Hz	Ni-Brass	7/8"-16 Mini AC	12
	NBB8-18GM55-US-V93 ⚡	8	Flush	Normally open	30 Hz	Ni-Brass	7/8"-16 Mini AC	13
	NBN15-18GM55-US-V93 ⚡	15	Nonflush	Normally open	30 Hz	Ni-Brass	7/8"-16 Mini AC	14

*Ni-Brass = nickel-plated brass

- ⚡ Stocked item
- Typical delivery 4 weeks or less
Consult factory for all other models

Look for this logo in the drawings to identify our X-Series extended range sensors



X-Series™
Sensing range 25-240% beyond "traditional" inductive sensors

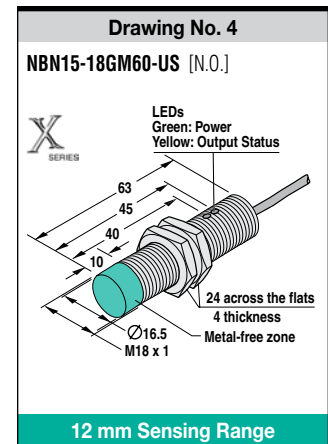
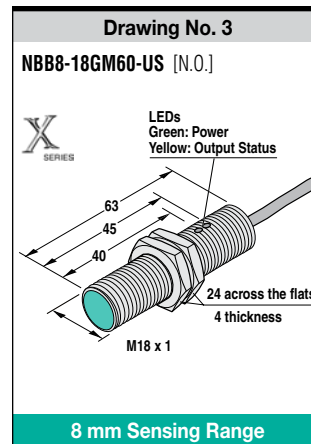
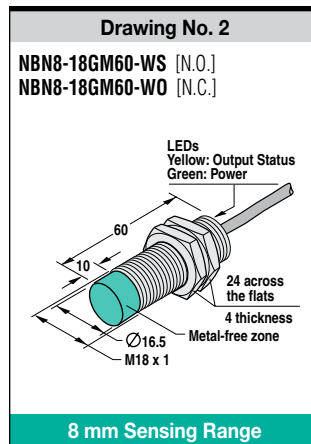
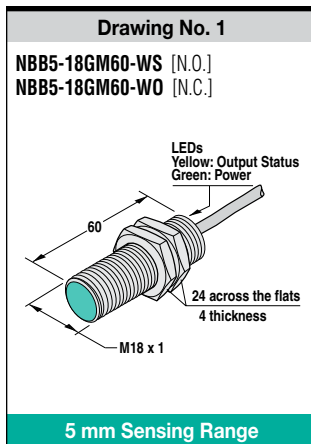

CONTINUED

18 mm Diameter

Inductive Cylindrical

2-Wire
AC &
AC/DC

Drawing No. 5
NBB5-18GM60-WS-V11 [N.O.]

LEDs
Yellow: Output Status
Green: Power

70
60
51
10
M12 x 1
24 across the flats
4 thickness
M18 x 1

5 mm Sensing Range

Drawing No. 6
NBN8-18GM60-WS-V11 [N.O.]

LEDs
Yellow: Output Status
Green: Power

70
60
51
10
M12 x 1
24 across the flats
4 thickness
Metal-free zone
Ø16.5
M18 x 1

8 mm Sensing Range

Drawing No. 7
NBB5-18GM60-WS-V12 [N.O.]
NBB5-18GM60-WO-V12 [N.C.]

LEDs
Yellow: Output Status
Green: Power

70
60
51
10
1/2"-20
24 across the flats
4 thickness
M18 x 1

5 mm Sensing Range

Drawing No. 8
NBN8-18GM60-WS-V12 [N.O.]

LEDs
Yellow: Output Status
Green: Power

70
60
51
10
1/2"-20
24 across the flats
4 thickness
Metal-free zone
Ø16.5
M18 x 1

8 mm Sensing Range

Drawing No. 9
NBB8-18GM60-US-V12 [N.O.]

LEDs
Green: Power
Yellow: Output Status

70
60
45
40
1/2"-20
24 across the flats
4 thickness
M18 x 1

8 mm Sensing Range

Drawing No. 10
NBN15-18GM60-US-V12 [N.O.]

LEDs
Green: Power
Yellow: Output Status

70
60
45
40
10
1/2"-20
24 across the flats
4 thickness
Metal-free zone
Ø16.5
M18 x 1

12 mm Sensing Range

Drawing No. 11
NBB5-18GM80-WS-V93 [N.O.]
NBB5-18GM80-WO-V93 [N.C.]

LEDs
Yellow: Output Status
Green: Power

80
60
51
10
7/8"-16
24 across the flats
4 thickness
M18 x 1

5 mm Sensing Range

Drawing No. 12
NBN8-18GM80-WS-V93 [N.O.]
NBN8-18GM80-WO-V93 [N.C.]

LEDs
Yellow: Output Status
Green: Power

80
60
51
10
7/8"-16
24 across the flats
4 thickness
Metal-free zone
Ø16.5
M18 x 1

8 mm Sensing Range

Drawing No. 13
NBB8-18GM55-US-V93 [N.O.]

LEDs
Green: Power
Yellow: Output Status

75
55
45
40
7/8"-16
24 across the flats
4 thickness
M18 x 1

8 mm Sensing Range

Drawing No. 14
NBN15-18GM55-US-V93 [N.O.]

LEDs
Green: Power
Yellow: Output Status

75
55
45
40
10
7/8"-16
24 across the flats
4 thickness
Metal-free zone
Ø16.5
M18 x 1

12 mm Sensing Range

18 mm Diameter

Recommended Accessories

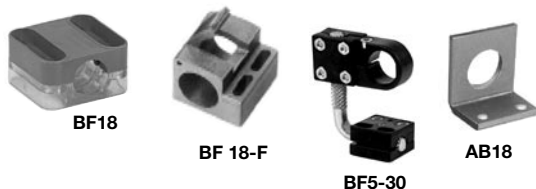

Mounting Brackets

Model	Description
BF18	12 mm clamp bracket
BF 18-F	12 mm snap lever bracket
BF5-30	5-30 mm universal bracket
AB18	12 mm right angle bracket

See pages 865-872 for complete accessory listing.



Mini Cordsets

Straight "Mini AC/DC" (7/8"-16)	
Model	Description
V93-G-YE2M-STOOW	2 m length, STOOW jacket
V93-G-YE4M-STOOW	4 m length, STOOW jacket

Right Angle "Mini AC/DC" (7/8"-16)	
Model	Description
V93-W-YE2M-STOOW	2 m length, STOOW jacket
V93-W-YE4M-STOOW	4 m length, STOOW jacket



Micro AC Cordsets

Straight "Micro" (M12)	
Model	Description
V11B-G-YE2M-PVC	2 m length, PVC jacket
V11B-G-YE4M-PVC	4 m length, PVC jacket

Right Angle "Micro" (M12)	
Model	Description
V11B-W-YE2M-PVC	2 m length, PVC jacket
V11B-W-YE4M-PVC	4 m length, PVC jacket

Straight "Micro" (1/2"-20)	
Model	Description
V12-G-YE2M-PVC	2 m length, PVC jacket
V12-G-YE5M-PVC	5 m length, PVC jacket

Right Angle "Micro" (1/2"-20)	
Model	Description
V12-W-YE2M-PVC	2 m length, PVC jacket
V12-W-YE5M-PVC	5 m length, PVC jacket

See pages 803-854 for complete cordset listing.

Inductive Cylindrical

2-Wire AC & AC/DC