

POWERSTAT Variable Transformers of the 136B-236B Series are available in single and three phase, manually operated and motor-driven assemblies. The 136B Series operates from 120 volt lines and the 236B Series from 240 volt lines. The rated output for constant current loads is 22 amperes for the 136B Series and 10 amperes for the 236B Series. For a constant impedance load the maximum rated output current at line voltage is 28 amperes for the 136B Series and 13 amperes for the 236B Series. POWERKOTE coils are featured on all units of the 136B-236B Series.

POWERSTAT Variable Transformers of the 136B-236B Series can be operated at any frequency between 50 and 2000 hertz. Figure A shows the reduction in allowable output current for operation higher than rated frequency. Figure B shows the regulation curves for types of the 136B-236B Series operating at full load current. Voltage drop is shown for any brush setting when full load is applied. For less than full load the voltage drop is proportional to the load. Driving torque, d-c resistance per coil and maximum core and brush loss when operating under no load are given in the chart. The shaft can be adjusted for general utility or back-of-panel mounting. Manually operated units have standard dials graduated 0-100. Terminal connections permit increasing output voltage with either clockwise or counter-clockwise rotation of the knob. The angle of rotation from zero to maximum output voltage is 316°.

Plug-in units have the same ratings as types 136B and 236B but offer the convenience of input cord-plugs, fuses and output receptacles housed in cast aluminum terminal enclosures. They can be converted to limit the output voltage to line voltage. Plugs and receptacles are shown in the outline for cord and plug types on page 21. Fused units of the 136B Series have 25 ampere fuses and those of the 236B Series have 10 ampere fuses.

Open construction units have the letter U suffix in the type number and the same electrical ratings and coil to terminal wiring as their corresponding enclosed construction models. They have no protective screening. Knobs can be placed at the base end for back-of-panel mounting because the shaft is removable.

POWERSTAT Variable Transformers of the 136B-236B Series are available in two- and three-gang assemblies in either enclosed or open construction. Most ganged units are provided with jumpers in the standard common position that may be moved or removed as desired.



TYPE 136B

U TYPES

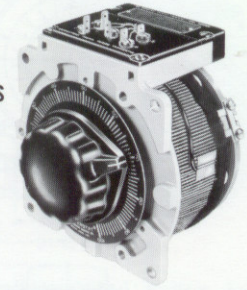

MOTOR-DRIVEN
SCREENED TYPES

Two- and three-gang assemblies of the 136B-236B Series connected for parallel operation to increase their current carrying capacity require chokes to insure equal division of load. Order choke type T5000B for two-gang assemblies and type T5579B for three-gang assemblies.

All except plug-in units in the 136B-236B Series are available with motor drives in standard speeds of 5, 15, 30 or 60 seconds for full range travel. Motor-driven models have an MD prefix in the type number and the identical electrical ratings of their corresponding manually-operated types. The motor is rated for an input of 120 volts, 50/60 hertz single phase with a current requirement of approximately 0.3 ampere. Stand-offs are provided for bench mounting and slotted brackets for against-the-wall mounting. When ordering, motor-driven units should be prefixed with the desired speed in seconds. For example: 5MD136B.

TYPE†	Approximate Driving Torque		No-Load Loss at 60 Hertz (Watts)	D-C Resistance per Coil* (Ohms)
	Oz-In	KpCm		
136B	30-50	2.2-3.6	15	0.27
136B-2	70-90	5-6.5	30	0.27
136B-3	110-140	7.9-10.1	45	0.27
236B	30-50	2.2-3.6	15	1.7
236B-2	70-90	5-6.5	30	1.7
236B-3	110-140	7.9-10.1	45	1.7

*Measured from start to end of winding.

†Data also applies to units having applicable prefixes and suffixes.

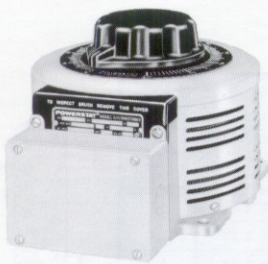

T TYPES

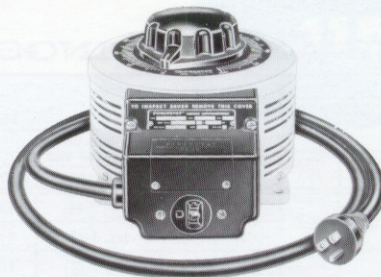

CORD-PLUG TYPES

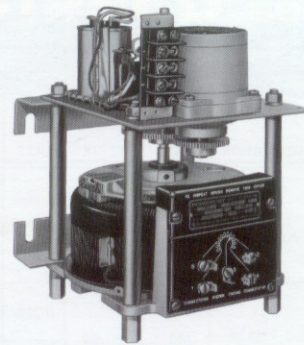

MOTOR-DRIVEN U TYPES

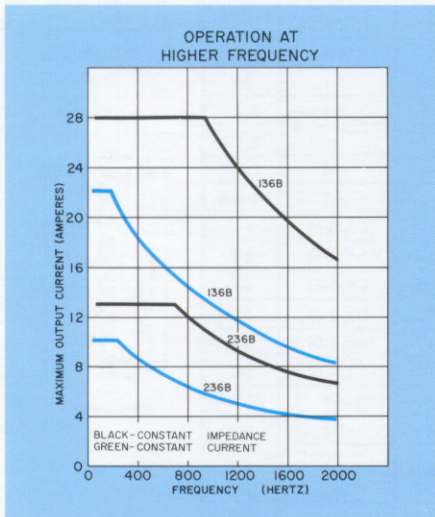

FIGURE A

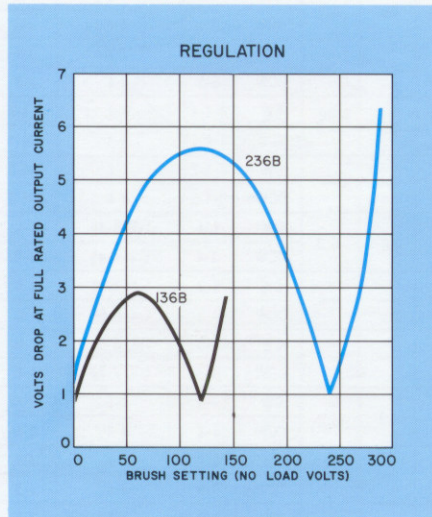

FIGURE B

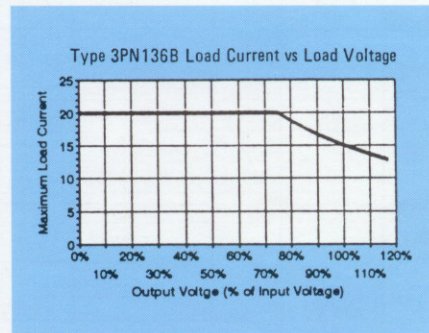
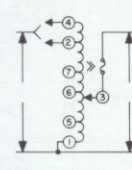
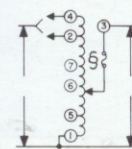

FIGURE C

TYPE	CONNECTION	INPUT		VOLTS	OUTPUT				KNOB ROTATION	TERMINALS			
		VOLTS	HERTZ		CONSTANT CURRENT LOAD		CONSTANT IMPEDANCE LOAD			KNOB ON RADIATOR END		KNOB ON BASE END	
					MAX. AMP.	MAX. KVA	MAX. AMP.	MAX. KVA		INPUT	OUTPUT	INPUT	OUTPUT
136B MD136B† 136BT MD136BT† 136BU MD136BU‡	#1	120	50/60	0-120	22	2.6	28	3.4	CW	1-4	1-3	1-4	3-4
				0-140	22	3.1	—	—	CCW	1-4	3-4	1-4	1-3
									CW	1-2	1-3	4-5	3-4
									CCW	4-5	3-4	1-2	1-3
F136B MDF136B‡	#2	120	50/60	0-120	22	2.6	28	3.4	CW	1-4	1-3	1-4	3-4
				0-140	22	3.1	—	—	CCW	1-4	3-4	1-4	1-3
									CW	1-2‡	1-3	4-5	3-4
									CCW	4-5	3-4	1-2	1-3
3PN136B**	#2	120	50/60	0-120	20	1.8	—	—	CW	1-4	1-3	1-4	3-4
				0-140	20	1.8	—	—	CCW	1-4	3-4	1-4	1-3
									CW	1-2‡	1-3	4-5	3-4
									CCW	4-5	3-4	1-2	1-3
236B MD236B‡ 236BT MD236BT† 236BU MD236BU‡	#1	240	50/60	0-240	10	2.4	13	3.1	CW	1-4	1-3	1-4	3-4
				0-280	10	2.8	—	—	CCW	1-4	3-4	1-4	1-3
									CW	1-2	1-3	4-5	3-4
									CCW	4-5	3-4	1-2	1-3
		120	50/60	0-280	10*	1.2†	—	—	CW	1-6	1-3	4-7	3-4
									CCW	4-7	3-4	1-6	1-3
F236B MDF236B‡ 3PN236B	#2	240	50/60	0-240	10	2.4	13	3.1	CW	1-4	1-3	1-4	3-4
				0-280	10	2.8	—	—	CCW	1-4	3-4	1-4	1-3
									CW	1-2‡	1-3	4-5	3-4
									CCW	4-5	3-4	1-2	1-3
		120□	50/60	0-280	10*	1.2	—	—	CW	1-6	1-3	4-7	3-4
									CCW	4-7	3-4	1-6	1-3



CONNECTION 1



CONNECTION 2

136B TYPES DO NOT HAVE TERMINALS 6 OR 7

CONNECTIONS SHOWN ARE FOR CW KNOB ROTATION, KNOB ON RADIATOR END (CCW ROTATION, KNOB ON BASE END)

*Maximum output current in output voltage range up to 150 volts. At higher output voltages, output current must be reduced according to rating curve Figure B on page 4.

†Maximum KVA at maximum output voltage. Maximum KVA at lower output voltages may be calculated from rating curve Figure B on page 4.

‡Motor-driven types use connections for CW rotation, knob on radiator end.

§Fuse supplied: 25 ampere on 136B types, 10 ampere on 236B types.

¶Cord-and-plug units wired this way when shipped.

□Not available on types F236B or MDF236B.

»Fuse recommended, not supplied.

**See Figure C.

CONNECTIONS AND RATINGS

TYPE	CONNECTION	INPUT		OUTPUT				ROTA-TION	TERMINALS										
		VOLTS	HERTZ	VOLTS	CONSTANT CURRENT LOAD		CONSTANT IMPEDANCE LOAD		KNOB ON RADIATOR END			KNOB ON BASE END							
					MAX. AMP.	MAX. KVA	MAX. AMP.		MAX. KVA	INPUT	JUMPER □	OUTPUT	INPUT	JUMPER □	OUTPUT				
													INPUT	JUMPER □	OUTPUT				
136BU-2 MD136BU-2+	#1 1-PHASE PARALLEL §	120	50/60	0-120	44	5.3	56	6.7	CW	1-4	1-1, 4-4 §	1-C	1-4	1-1, 4-4 §	4-C				
				CCW	1-4	1-1, 4-4 §	4-C	1-4	1-1, 4-4 §	1-C									
		0-140	44	6.2	—	—	CW	1-2	1-1, 2-2 §	1-C	4-5	4-4, 5-5 §	4-C						
		CCW	4-5	4-4, 5-5 §	4-C	1-2	1-1, 2-2 §	1-C											
	#2 1-PHASE SERIES	240	50/60	0-240	22	5.3	28	6.7	CW	4-4	1-1	3-3	1-1	4-4	3-3				
				CCW	1-1	4-4	3-3	4-4	1-1	3-3									
		0-280	22	6.2	—	—	CW	2-2	1-1	3-3	5-5	4-4	3-3						
		CCW	5-5	4-4	3-3	2-2	1-1	3-3											
	#2 3-PHASE OPEN DELTA	120	50/60	0-120	22	4.6	28	5.8	CW	4-1-4	1-1	3-1-3	1-4-1	4-4	3-4-3				
				CCW	1-4-1	4-4	3-4-3	4-1-4	1-1	3-1-3									
		0-140	22	5.3	—	—	CW	2-1-2	1-1	3-1-3	5-4-5	4-4	3-4-3						
		CCW	5-4-5	4-4	3-4-3	2-1-2	1-1	3-1-3											
236BU-2 MD236BU-2+	#1 1-PHASE PARALLEL §	240	50/60	0-240	20	4.8	26	6.2	CW	1-4	1-1, 4-4 §	1-C	1-4	1-1, 4-4 §	4-C				
				CCW	1-4	1-1, 4-4 §	4-C	1-4	1-1, 4-4 §	1-C									
				0-280	20	5.6	—	—	CW	1-2	1-1, 2-2 §	1-C	4-5	4-4, 5-5 §	4-C				
				CCW	4-5	4-4, 5-5 §	4-C	1-2	1-1, 2-2 §	1-C									
		120	50/60	0-280	20**	2.4 †	—	—	CW	1-6	1-1, 6-6 §	1-C	4-7	4-4, 7-7 §	4-C				
				CCW	4-7	4-4, 7-7 §	4-C	1-6	1-1, 6-6 §	1-C									
				480	50/60	0-480	10	4.8	13	6.2	CW	4-4	1-1	3-3	1-1	4-4	3-3		
						CCW	1-1	4-4	3-3	4-4	1-1	3-3							
	0-560	10	5.6			—	—	CW	2-2	1-1	3-3	5-5	4-4	3-3					
	CCW	5-5	4-4			3-3	2-2	1-1	3-3										
	240	50/60	0-560	10**	2.4 †	—	—	CW	6-6	1-1	3-3	7-7	4-4	3-3					
			CCW	7-7	4-4	3-3	6-6	1-1	3-3										
			#2 1-PHASE SERIES	240	50/60	0-240	10	4.2	13	5.4	CW	4-1-4*	1-1	3-1-3	1-4-1	4-4	3-4-3		
						CCW	1-4-1	4-4	3-4-3	4-1-4	1-1	3-1-3							
	0-280	10				4.8	—	—	CW	2-1-2	1-1	3-1-3	5-4-5	4-4	3-4-3				
	CCW	5-4-5				4-4	3-4-3	2-1-2	1-1	3-1-3									
	120	50/60		0-280	10**	2.1 †	—	—	CW	6-1-6	1-1	3-1-3	7-4-7	4-4	3-4-3				
				CCW	7-4-7	4-4	3-4-3	6-1-6	1-1	3-1-3									
				136BU-3 MD136BU-3+	#3 1-PHASE PARALLEL *	120	50/60	0-120	66	7.9	84	10.1	CW	1-4	1-1-1, 4-4-4*	1-C	1-4	1-1-1, 4-4-4*	4-C
								CCW	1-4	1-1-1, 4-4-4*	4-C	1-4	1-1-1, 4-4-4*	1-C					
	0-140	66	9.2			—	—	CW	1-2	1-1-1, 2-2-2*	1-C	4-5	4-4-4, 5-5-5*	4-C					
	CCW	4-5	4-4-4, 5-5-5*			4-C	1-2	1-1-1, 2-2-2*	1-C										
	#4 3-PHASE WYE	240	50/60		0-240	22	9.1	28	11.6	CW	4-4-4	1-1-1	3-3-3	1-1-1	4-4-4	3-3-3			
					CCW	1-1-1	4-4-4	3-3-3	4-4-4	1-1-1	3-3-3								
60		0-280	22		10.7	—	—	CW	2-2-2	1-1-1	3-3-3	5-5-5	4-4-4	3-3-3					
CCW		5-5-5	4-4-4		3-3-3	2-2-2	1-1-1	3-3-3											
236BU-3 MD236BU-3+	#3 1-PHASE PARALLEL *	240	50/60		0-240	30	7.2	39	9.4	CW	1-4	1-1-1, 4-4-4*	1-C	1-4	1-1-1, 4-4-4*	4-C			
					CCW	1-4	1-1-1, 4-4-4*	4-C	1-4	1-1-1, 4-4-4*	1-C								
					0-280	30	8.4	—	—	CW	1-2	1-1-1, 2-2-2*	1-C	4-5	4-4-4, 5-5-5*	4-C			
		CCW	4-5		4-4-4, 5-5-5*	4-C	1-2	1-1-1, 2-2-2*	1-C										
		120	50/60	0-280	30**	3.6 †	—	—	CW	1-6	1-1-1, 6-6-6*	1-C	4-7	4-4-4, 7-7-7*	4-C				
				CCW	4-7	4-4-4, 7-7-7*	4-C	1-6	1-1-1, 6-6-6*	1-C									
	#4 3-PHASE WYE			480	50/60	0-480	10	8.3	13	10.8	CW	4-4-4	1-1-1	3-3-3	1-1-1	4-4-4	3-3-3		
		CCW	1-1-1			4-4-4	3-3-3	4-4-4	1-1-1	3-3-3									
		60	0-560	10	9.7	—	—	CW	2-2-2	1-1-1	3-3-3	5-5-5	4-4-4	3-3-3					
		CCW	5-5-5	4-4-4	3-3-3	2-2-2	1-1-1	3-3-3											
		240	60	0-560	10**	4.2 †	—	—	CW	6-6-6	1-1-1	3-3-3	7-7-7	4-4-4	3-3-3				
					CCW	7-7-7	4-4-4	3-3-3	6-6-6	1-1-1	3-3-3								

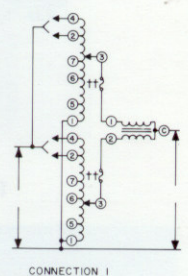

CONNECTION 1

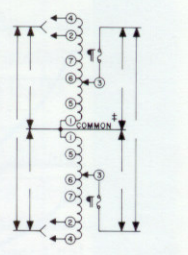

CONNECTION 2

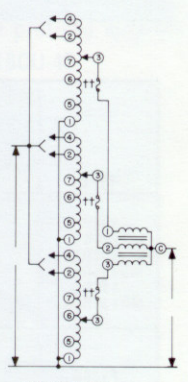

CONNECTION 3

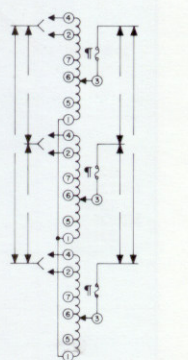

CONNECTION 4

**136B TYPES
DO NOT HAVE
TERMINALS
6 OR 7**

**CONNECTIONS
SHOWN ARE FOR
CW KNOB
ROTATION,
KNOB ON BASE END
(CCW ROTATION,
KNOB ON
RADIATOR END)**

*Jumpers also required connecting #3 on first unit to #1 on choke, #3 on second unit to #2 on choke and #3 on third unit to #3 on choke. T5579B choke required.

**Maximum output current in output voltage range from 0 to 25 percent above line voltage. At higher output voltages output current must be reduced according to rating curve Figure B on page 4.

†Maximum KVA at maximum output voltage. Maximum KVA at lower output voltages may be calculated from rating curve Figure B on page 4.

‡Units must be fused. 25 ampere fuses supplied internally on F136B types, 10 ampere on F236B types. On other types, fuses must be wired as shown.

§Common used as third leg in 3-phase open delta or neutral in 3-wire single phase series and 4-wire 3-phase wye connections; not used in 2-wire series or 3-wire wye connections.

¶Jumpers also required connecting #3 on first unit to #1 on choke and connecting #3 on second unit to #2 on choke. T5000B choke required.

*Fuses recommended on all units. 25 ampere fuses supplied internally on F136B types, 10 ampere on F236B types.

□Jumper provided in standard common position should be moved or removed as required.

+Motor-driven types use connections for CW rotation, knob on radiator end.

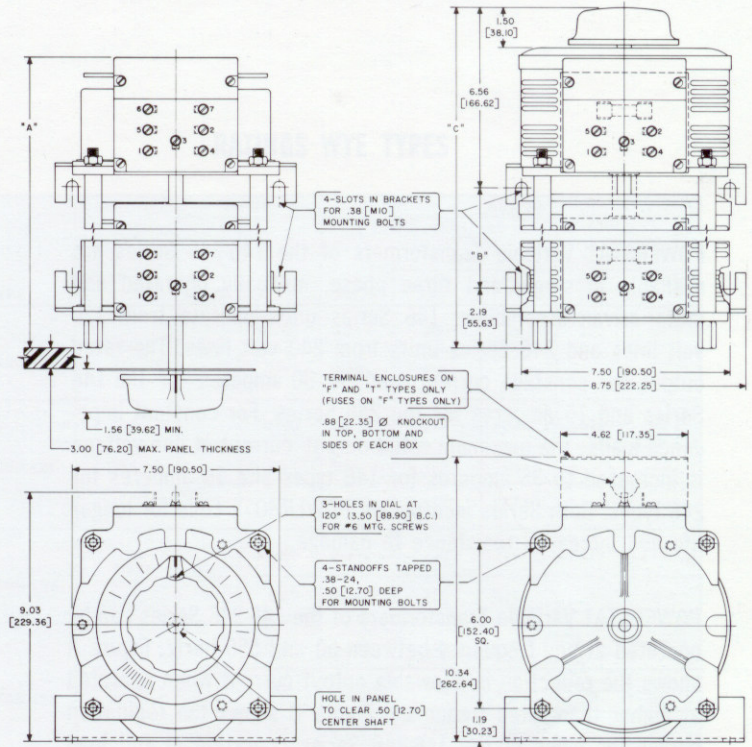
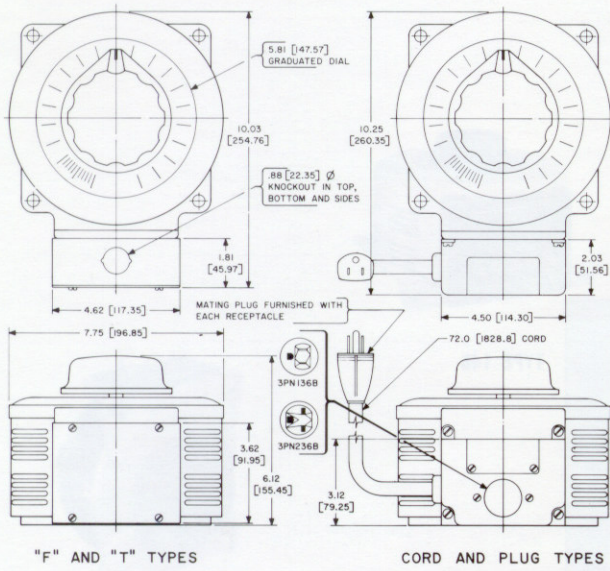

TYPE	"A"	"B"	"C"	"D"	"E"	"F"
SINGLE UNIT	—	—	—	12.25 [311.15]	11.97 [304.04]	4.50 [114.30]
2-GANG	10.62 [269.75]	3.69 [93.72]	12.44 [315.98]	14.46 [367.02]	17.56 [448.91]	9.81 [249.17]
3-GANG	15.94 [404.87]	9.00 [228.60]	17.75 [450.85]	22.87 [580.90]	22.60 [574.04]	15.12 [384.05]

