

LM185-1.2/LM285-1.2/LM385-1.2 Micropower Voltage Reference Diode

General Description

The LM185-1.2/LM285-1.2/LM385-1.2 are micropower 2-terminal band-gap voltage regulator diodes. Operating over a 10µA to 20mA current range, they feature exceptionally low dynamic impedance and good temperature stability. On-chip trimming is used to provide tight voltage tolerance. Since the LM185-1.2 band-gap reference uses only transistors and resistors, low noise and good long term stability result.

Careful design of the LM185-1.2 has made the device exceptionally tolerant of capacitive loading, making it easy to use in almost any reference application. The wide dynamic operating range allows its use with widely varying supplies with excellent regulation.

The extremely low power drain of the LM185-1.2 makes it useful for micropower circuitry. This voltage reference can be used to make portable meters, regulators or general purpose analog circuitry with battery life approaching shelf life.

Further, the wide operating current allows it to replace older references with a tighter tolerance part.

The LM185-1.2 is rated for operation over a -55°C to 125°C temperature range while the LM285-1.2 is rated -40°C to 85°C and the LM385-1.2 0°C to 70°C. The LM185-1.2/LM285-1.2 are available in a hermetic TO-46 package and the LM285-1.2/LM385-1.2 are also available in a low-cost TO-92 molded package, as well as SO and SOT-23. The LM185-1.2 is also available in a hermetic leadless chip carrier package.

Features

- ±1% and 2% initial tolerance
- Operating current of 10µA to 20mA
- 1Ω dynamic impedance
- Low temperature coefficient
- Low voltage reference—1.235V
- 2.5V device and adjustable device also available
- LM185-2.5 series and LM185 series, respectively

Connection Diagrams

**T0-92
Plastic Package (Z)**

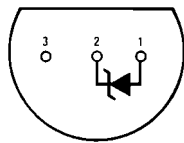

551810

Bottom View

Order Number LM285Z-1.2,
LM285BXZ-1.2, LM285BYZ-1.2
LM385Z-1.2, LM385BZ-1.2
LM385BXZ-1.2 or LM385BYZ-1.2
See NS Package Number Z03A

SOT23

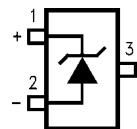

551833

* Pin 3 is attached to the Die Attach Pad (DAP) and should be connected to Pin 2 or left floating.

Order Number LM385M3-1.2
See NS Package Number MF03A

SO Package

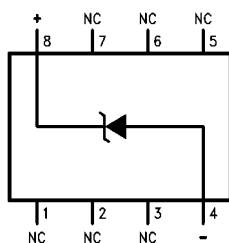

551809

Order Number LM285M-1.2,
LM285BXM-1.2, LM285BYM-1.2
LM385M-1.2, LM385BM-1.2
LM385BXM-1.2 or LM385BYM-1.2
See NS Package Number M08A

**TO-46
Metal Can Package (H)**

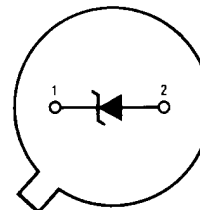

551806

Bottom View

Order Number LM185H-1.2, LM185H-1.2/883,
LM185BXH-1.2, LM185BYH-1.2
LM285H-1.2 or LM285BXH-1.2
See NS Package Number H02A

Absolute Maximum Ratings (Note 1)

If Military/Aerospace specified devices are required, please contact the National Semiconductor Sales Office/Distributors for availability and specifications.

(Note 2)

Reverse Current	30mA
Forward Current	10mA
Operating Temperature Range (Note 3)	
LM185-1.2	-55°C to +125°C
LM285-1.2	-40°C to +85°C
LM385-1.2	0°C to 70°C

ESD Susceptibility (Note 9)

2kV

Storage Temperature

-55°C to +150°C

Soldering Information

TO-92 package: 10 sec.

260°C

TO-46 package: 10 sec.

300°C

SO and SOT Pkg.

Vapor phase (60 sec.)

215°C

Infrared (15 sec.)

220°C

See AN-450 "Surface Mounting Methods and Their Effect on Product Reliability" for other methods of soldering surface mount devices.

Electrical Characteristics (Note 4)

Parameter	Conditions	Typ	LM185-1.2		LM385B-1.2		LM385-1.2		Units (Limit)	
			LM185BX-1.2		LM385BX-1.2					
			LM185BY-1.2		LM385BY-1.2					
			LM285-1.2							
			LM285BX-1.2							
			LM285BY-1.2							
			Tested Limit	Design Limit	Tested Limit	Design Limit	Tested Limit	Design Limit		
			(Notes 5, 8)	(Note 6)	(Note 5)	(Note 6)	(Note 5)	(Note 6)		
Reverse Breakdown Voltage	$T_A = 25^\circ\text{C}$, $10\mu\text{A} \leq I_R \leq 20\text{mA}$	1.23 5	1.223		1.223		1.205		V(Min)	
			1.247		1.247		1.260		V(Max)	
Minimum Operating Current	LM385M3-1.2	8	10	20	15	20	15	20	μA (Max)	
Reverse Breakdown Voltage Change with Current	$10\mu\text{A} \leq I_R \leq 1\text{mA}$		1	1.5	1	1.5	1	1.5	mV (Max)	
	$1\text{mA} \leq I_R \leq 20\text{mA}$		10	20	20	25	20	25	mV (Max)	
Reverse Dynamic Impedance	$I_R = 100\mu\text{A}$, $f = 20\text{Hz}$	1							Ω	
Wideband Noise (rms)	$I_R = 100\mu\text{A}$, $10\text{Hz} \leq f \leq 10\text{kHz}$	60							μV	
Long Term Stability	$I_R = 100\mu\text{A}$, $T = 1000\text{Hr}$, $T_A = 25^\circ\text{C} \pm 0.1^\circ\text{C}$	20							ppm	
Average Temperature Coefficient (Note 7)	$I_R = 100\mu\text{A}$ X Suffix Y Suffix All Others		30 50		30 50		150	150	ppm/ $^\circ\text{C}$ ppm/ $^\circ\text{C}$ ppm/ $^\circ\text{C}$ (Max)	

Note 1: Absolute Maximum Ratings indicate limits beyond which damage to the device may occur. Operating Ratings indicate conditions for which the device is intended to be functional, but do not guarantee specific performance limits. For guaranteed specifications and test conditions, see the Electrical Characteristics. The guaranteed specifications apply only for the test conditions listed.

Note 2: Refer to RETS185H-1.2 for military specifications.

Note 3: For elevated temperature operation, T_j max is:

LM185	150°C
LM285	125°C
LM385	100°C

Thermal Resistance	TO-92	TO-46	SO-8	SOT23
θ_{JA} (junction to ambient)	180°C/W (0.4 leads) 170°C/W (0.125 leads)	440°C/W	165°C/W	283°C/W
θ_{JC} (junction to case)	N/A	80°C/W	N/A	N/A

Note 4: Parameters identified with boldface type apply at temperature extremes. All other numbers apply at $T_A = T_J = 25^\circ\text{C}$.

Note 5: Guaranteed and 100% production tested.

Note 6: Guaranteed, but not 100% production tested. These limits are not used to calculate average outgoing quality levels.

Note 7: The average temperature coefficient is defined as the maximum deviation of reference voltage at all measured temperatures between the operating T_{MAX} and T_{MIN} , divided by $T_{MAX} - T_{MIN}$. The measured temperatures are -55°C , -40°C , 0°C , 25°C , 70°C , 85°C , 125°C .

Note 8: A military RETS electrical specification is available on request.

Note 9: The human body model is a 100 pF capacitor discharged through a 1.5 kΩ resistor into each pin.

Typical Performance Characteristics

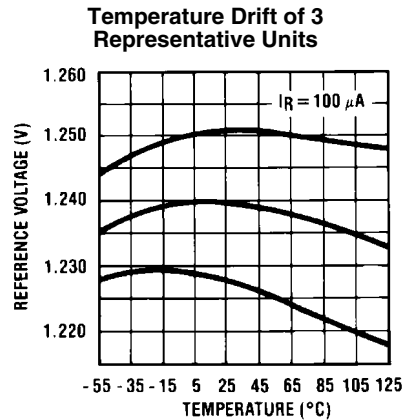
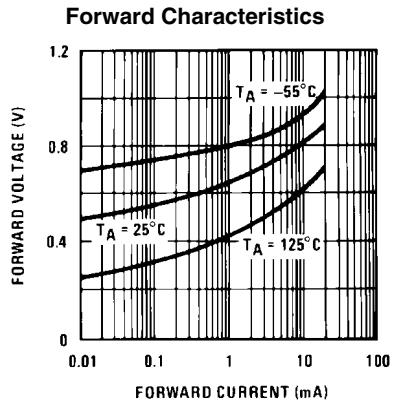
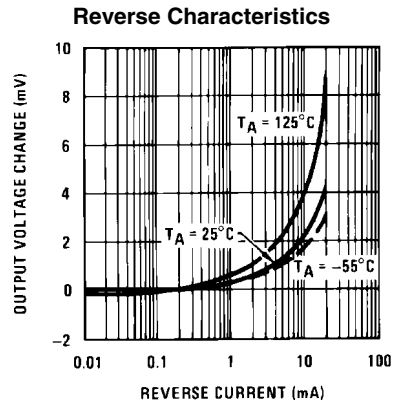
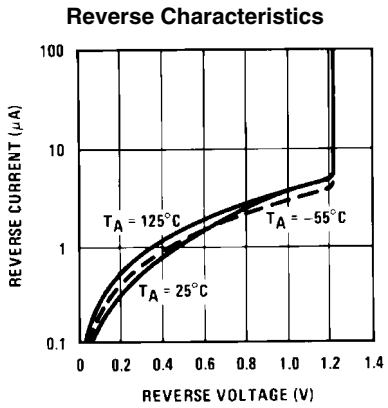

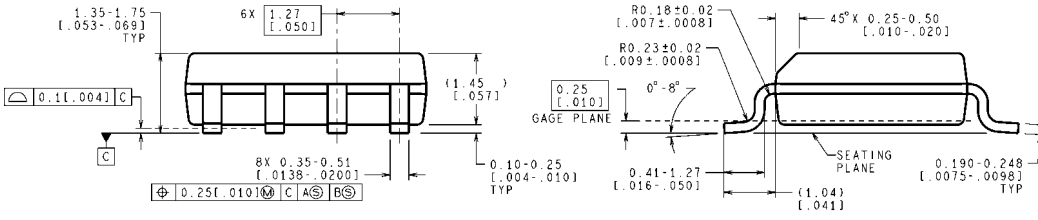
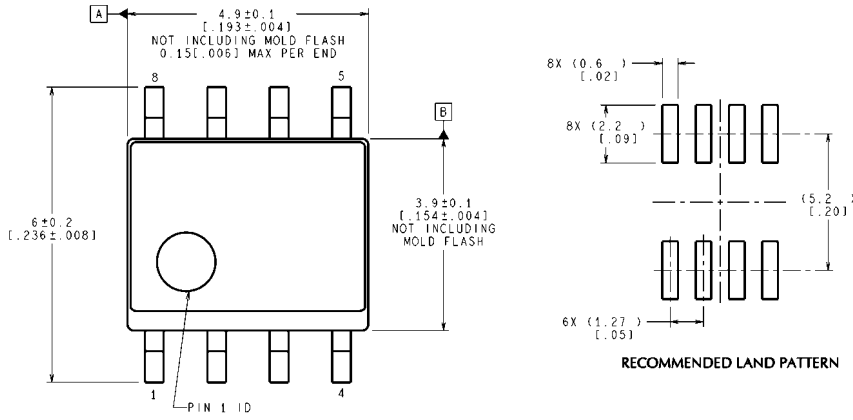

CONTROLLING DIMENSION IS MILLIMETER
VALUES IN [] ARE INCHES
DIMENSIONS IN () FOR REFERENCE ONLY

M08A (Rev L)

Small Outline (SO-8) Package
Order Number LM285M-1.2, LM285BXM-1.2, LM285BYM-1.2
LM385M-1.2, LM385BM-1.2, LM385BXM-1.2, LM385BYM-1.2
NS Package Number M08A

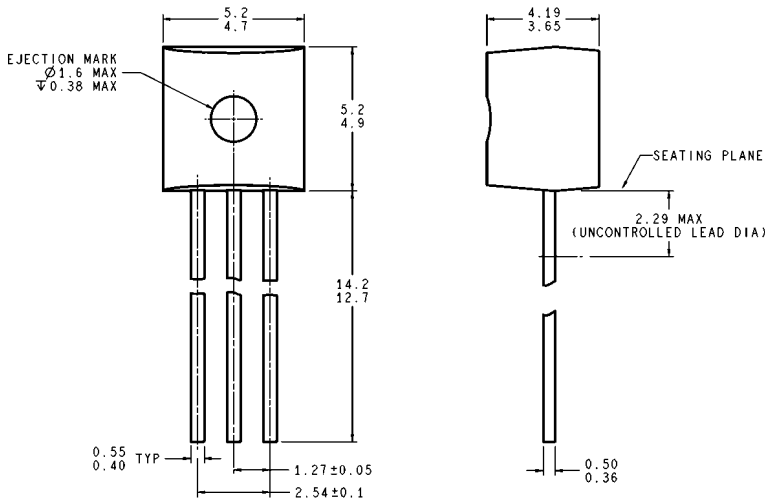

DIMENSIONS ARE IN MILLIMETERS

Z03A (Rev G)

TO-92 Plastic Package (Z)
Order Number LM285Z-1.2, LM285BXZ-1.2
LM285BYZ-1.2, LM385Z-1.2, LM385BZ-1.2
LM385BXZ-1.2 or LM385BYZ-1.2
NS Package Number Z03A