

**RoHS** **HTxxx & HTMxxx & STxxx Series**



**Description**

The HTM, HT, and ST series of bilateral trigger DIACs offer a range of voltage characteristics from 27V to 70V. A DIAC semiconductor is a full-wave or bidirectional Thyristor. It is triggered from a blocking state to a conduction state for either polarity of applied voltage whenever the amplitude of applied voltage exceeds the breakover voltage of the DIAC.

**Features & Benefits**

- **RoHS** compliant
  - Bilateral triggering device
  - Glass-passivated junctions
  - Wide voltage range selections
  - Long-term reliability
  - Parameter stability
  - Reliable barrier against junction contamination
- ST Series:**
- Epoxy SM package (DO-214)
  - High-temperature, solder bonded die attachment
- HTM/HT Series:**
- MINIMELF/DO-35 trigger package

**Schematic Symbol**



**Applications**

DIACs are used to trigger Triacs and SCRs in phase control circuits for lamp dimming, universal motor speed control, and heat control. They are used also for triggering transistors in solid state ballast lighting controls.

**Absolute Maximum Ratings**

Symbol	Parameter	Test Conditions	Min	Max	Unit
$I_{TRM}$	Pulse On-State Current	120PPS, $T_A \leq 40^\circ\text{C}$ pulse width = 10 $\mu\text{s}$		2 1.5 <sup>(*)</sup>	A
$T_S$	Storage Temperature Range		-40	+125	$^\circ\text{C}$
$T_J$	Operating Junction Temperature		-40	+125	$^\circ\text{C}$
$P_{D(AV)}$	Device Power Dissipation	$T_A = -40^\circ\text{C}$ to $+40^\circ\text{C}$		See Product Selector Table	mW

(\*)Only Applies to HT-60

Notes:

1. Service Dissipation (at  $T_A = -40^\circ\text{C}$  to  $+40^\circ\text{C}$ ): 250mW for DO-35 and MINIMELF/SOD-80 and 300mW for DO214
2. Above  $+40^\circ\text{C}$ , Derate: 3.6mW/ $^\circ\text{C}$  for DO-35 and MINIMELF/SOD-80 and 3mW/ $^\circ\text{C}$  for DO214

**Electrical Characteristics (T<sub>j</sub> = 25°C, unless otherwise specified)**

Symbol	Description	Test Conditions	Min	Max	Unit
V <sub>BO</sub>	Breakover/Trigger Voltage	50/60Hz Sine Wave	See Product Selector Table	See Product Selector Table	V
ΔV <sub>BO</sub>	Breakover Voltage Symmetry	+V <sub>BO</sub> to -V <sub>BO</sub>		2 <sup>(Note 1)</sup>	V
V <sub>BB</sub>	Δ Breakback Voltage <sup>(Note 4)</sup>	V <sub>BO</sub> to V <sub>10mA</sub>	5		V
		V <sub>BO</sub> to V <sub>6mA</sub> <sup>(*)</sup>	15		V
V <sub>BB (DYN)</sub>	Dynamic Δ Breakback Voltage <sup>(Notes 2 &amp; 3)</sup>	120 PPS	10		V
I <sub>BO</sub>	Breakover Current	50/60Hz Sine Wave		15	μA

(\*) Only Applies to HT-60

Electrical Characteristic Notes:

1. Breakover voltage symmetry as close as 1V is available from the factory for these products.
2. See Figure 4 and Figure 5 for test circuit and waveforms.

3. Typical switching time is 900 nano-seconds measured at I<sub>pk</sub> (Figure 4) across a 20 Ω resistor (Figure 5). Switching time is defined as rise time of I<sub>pk</sub> between the 10% to 90% points

4. See V-I Characteristics  
Static Characteristics - Not Applicable

**Product Selector**

Part Number	Package Availability			V <sub>BO</sub>	
	MINIMELF	DO-35	DO-214	MIN	MAX
XX-32	—	HT-32	ST-32	27V	37V
XX-32A/ 5761	—	HT-32A	—	28V	36V
XX-32B/ 5761A	HTM-32B	HT-32B	ST-32B	30V	34V
XX-34B	—	HT-34B	ST-34B	32V	36V
XX-35	—	HT-35	ST-35	30V	40V
XX-36A/ 5762	—	HT-36A	ST-36A	32V	40V
XX-36B	—	HT-36B	ST-36B	34V	38V
XX-40	—	HT-40	ST-40	35V	45V
XX-60	—	HT-60	—	56V	70V

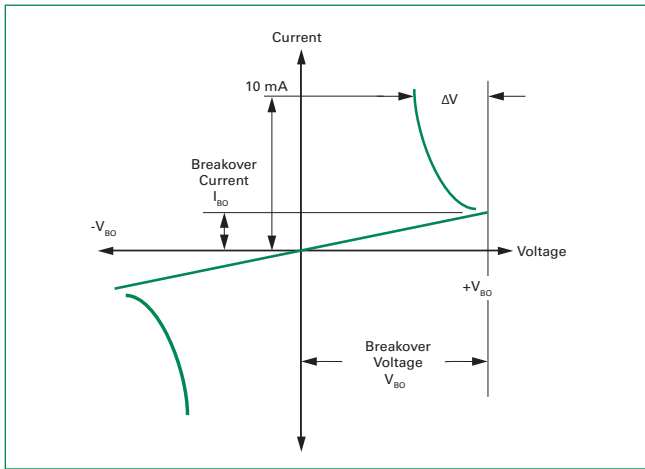
"XX" = HTM for MINIMELF  
HT for DO-35  
ST for DO-214

**Thermal Resistances**

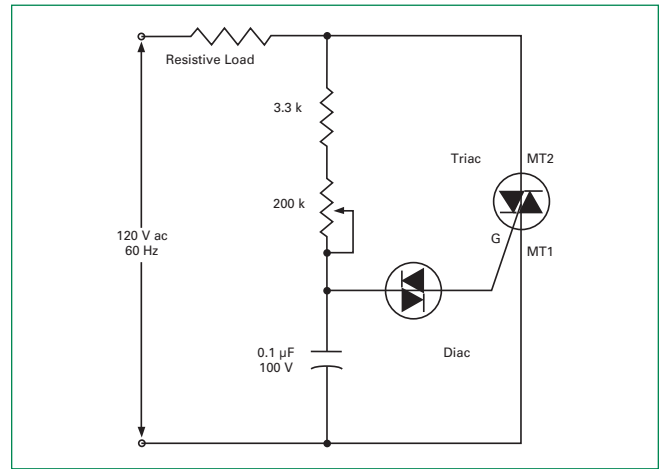
Symbol	Description	Test Conditions	Value	Unit	
R <sub>θ(J-L)</sub>	Junction to Lead	Maximum Lead Temperature: 85°C	DO-35	100	°C/W
		Maximum Lead Temperature: 90°C	DO-214	65*	°C/W
		Maximum Lead Temperature: 87°C	MINIMELF	75	°C/W
R <sub>θ(J-A)</sub>	Junction to Ambient	Free-Air	DO-35	278	°C/W

\* Mounted on 1 cm<sup>2</sup> copper foil surface; two-ounce copper foil

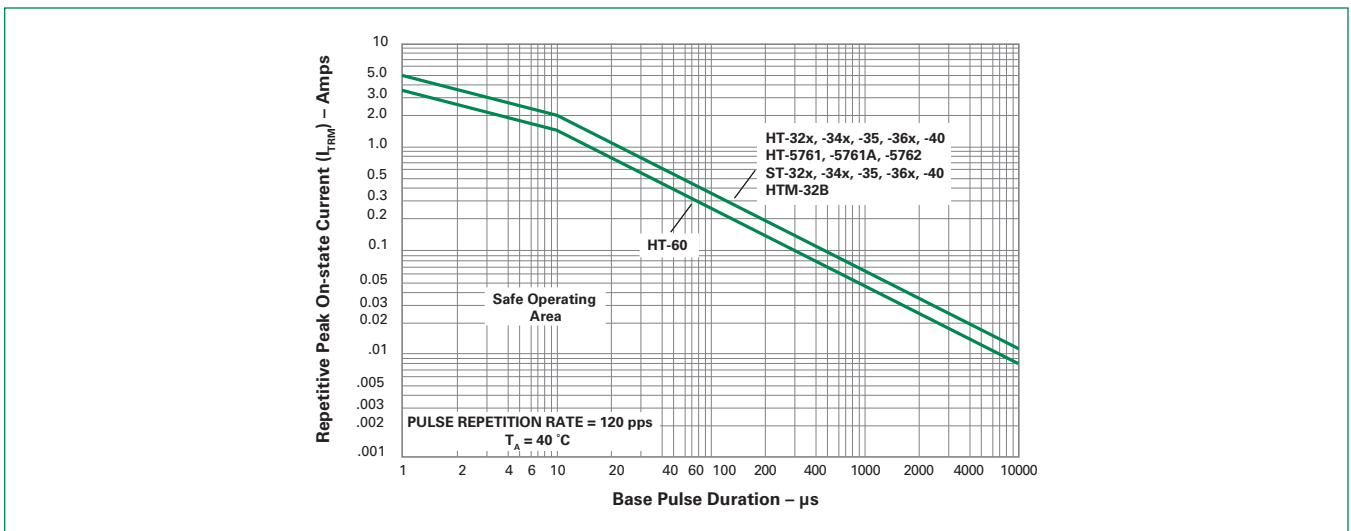
**Figure 1: V-I Characteristics**



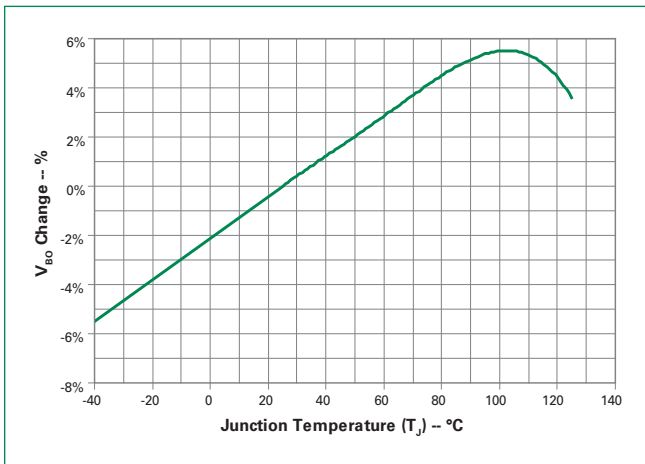
**Figure 2: Typical DIAC/Triac Full-wave Phase Control Circuit**



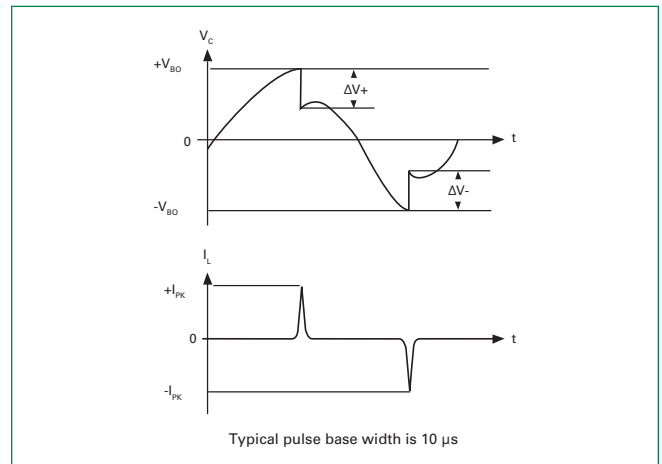
**Figure 3: Repetitive Peak On-state Current vs. Pulse Duration**



**Figure 4: Normalized  $V_{BO}$  Change vs. Junction Temperature**

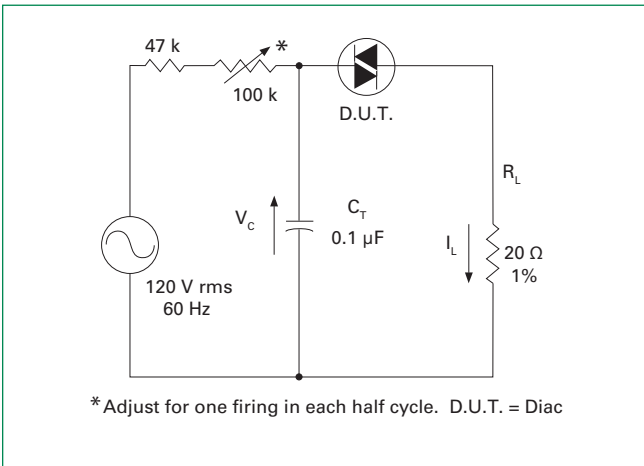


**Figure 5: Test Circuit Waveforms (Refer to Figure 5)**

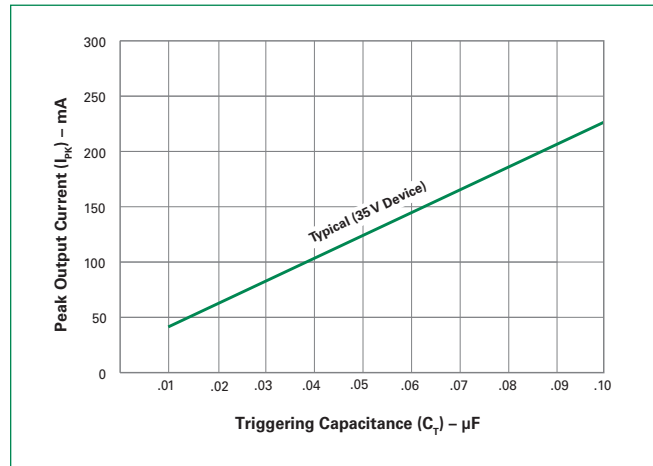


DIACs

**Figure 6: Circuit Used to Measure DIAC Characteristics (Refer to Figure 4)**

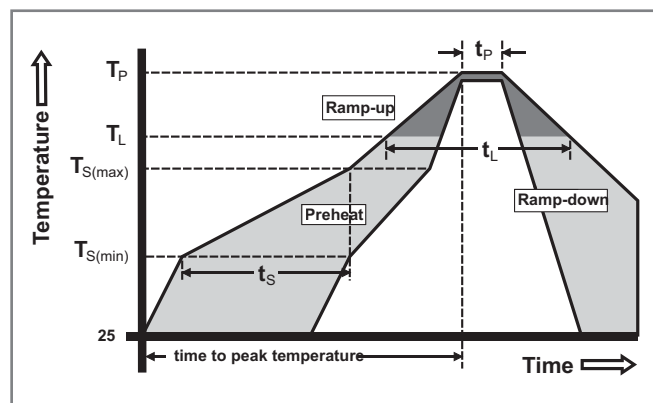


**Figure 7: Peak Output Current vs. Triggering Capacitance (Per Figure 5 with  $R_L$  of 20 Ω)**



**Soldering Parameters**

Reflow Condition		Pb – Free assembly
Pre Heat	- Temperature Min ( $T_{s(min)}$ )	150°C
	- Temperature Max ( $T_{s(max)}$ )	200°C
	- Time (min to max) ( $t_s$ )	60 – 190 secs
Average ramp up rate (Liquidus Temp ( $T_L$ ) to peak)		5°C/second max
$T_{s(max)}$ to $T_L$ - Ramp-up Rate		5°C/second max
Reflow	- Temperature ( $T_L$ ) (Liquidus)	217°C
	- Time (min to max) ( $t_s$ )	60 – 150 seconds
Peak Temperature ( $T_p$ )		260 °C
Time within 5°C of actual peak Temperature ( $t_p$ )		20 – 40 seconds
Ramp-down Rate		5°C/second max
Time 25°C to peak Temperature ( $T_p$ )		8 minutes Max.
Do not exceed		280°C



**Physical Specifications**

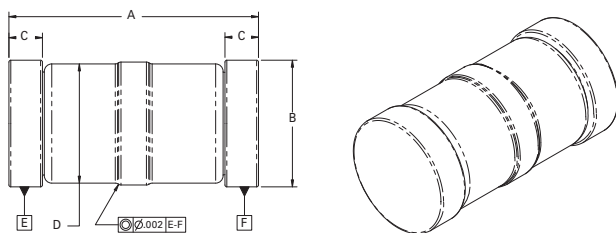
<b>Terminal Finish</b>	100% Matte-Tin Plated/ Pb-Free Solder Dipped
<b>Body Material</b>	DO-214: UL recognized epoxy meeting flammability classification 94V-0. DO-35/MINIMELF: Glass case body
<b>Lead Material</b>	DO-214: Copper Alloy DO-35/MINIMELF: Copper Clad Iron

**Design Considerations**

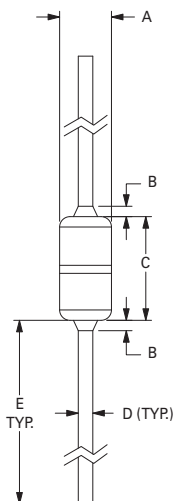
Careful selection of the correct device for the application's operating parameters and environment will go a long way toward extending the operating life of the Thyristor. Overheating and surge currents are the main killers of DIACs. Correct mounting, soldering, and forming of the leads also help protect against component damage.

**Reliability/Environmental Tests**

Test	Specifications and Conditions
<b>High Temperature Voltage Blocking</b>	MIL-STD-750, M-1040, Cond A Applied 80% of Rated Min $V_{BO}$ (VAC-peak) @ 125°C for 1008 hours
<b>Temperature Cycling</b>	MIL-STD-750, M-1051, 100 cycles; -40°C to +150°C; 15-min dwell-time
<b>Temperature/Humidity</b>	EIA / JEDEC, JESD22-A101 1008 hours; 80% of Rated Min $V_{BO}$ ( $V_{DC}$ ): 85°C; 85% rel humidity
<b>High Temp Storage</b>	MIL-STD-750, M-1031, 1008 hours; 150°C
<b>Low-Temp Storage</b>	1008 hours; -40°C
<b>Thermal Shock</b>	MIL-STD-750, M-1056 10 cycles; 0°C to 100°C; 5-min dwell time at each temperature; 10 sec (max) transfer time between temperature
<b>Autoclave</b>	EIA / JEDEC, JESD22-A102 168 hours (121°C at 2 ATMs) and 100% R/H
<b>Resistance to Solder Heat</b>	MIL-STD-750 Method 2031
<b>Solderability</b>	ANSI/J-STD-002, category 3, Test A
<b>Lead Bend</b>	MIL-STD-750, M-2036 Cond E
<b>Burn-in</b>	1 firing per 1/2 cycle, 168 hours

**Dimensions – MINIMELF / SOD-80 (MM Package)**


Dimensions	Inches			Millimeters		
	Min	Typ	Max	Min	Typ	Max
A	0.125	0.134	0.142	3.18	3.40	3.61
B	0.066	0.068	0.070	1.68	1.73	1.78
C	0.012	0.018	0.020	0.30	0.46	0.51
D	—	0.063	—	—	1.60	—

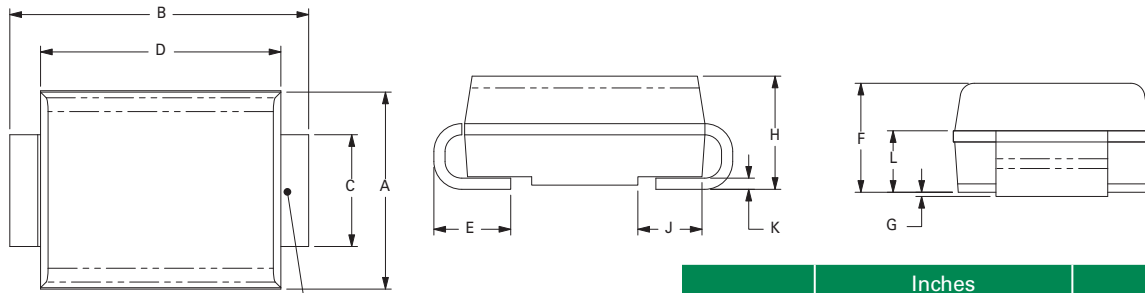
**Dimensions – DO-35 (Y Package)**


Dimension	Inches		Millimeters	
	Min	Max	Min	Max
A (Note 1)	0.060	0.090	1.530	2.280
B (Note 2)		0.015		0.381
C (Note 1)	0.135	0.165	3.430	4.190
D	0.018	0.022	0.458	0.558
E	1.000		25.400	

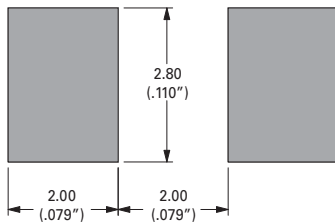
## Notes:

- Package contour optional within dimensions A and C. Slugs, if any, shall be included within this cylinder but shall not be subject to the minimum limit of Dimension A.
- Lead diameter is not controlled in this zone to allow for flash, lead finish build-up and minor irregularities other than slugs.

Dimensions – DO-214 (S Package)



T<sub>c</sub>/T<sub>L</sub> TEMPERATURE  
MEASUREMENT POINT



Recommended Soldering Pad Outline  
(Reference Only)

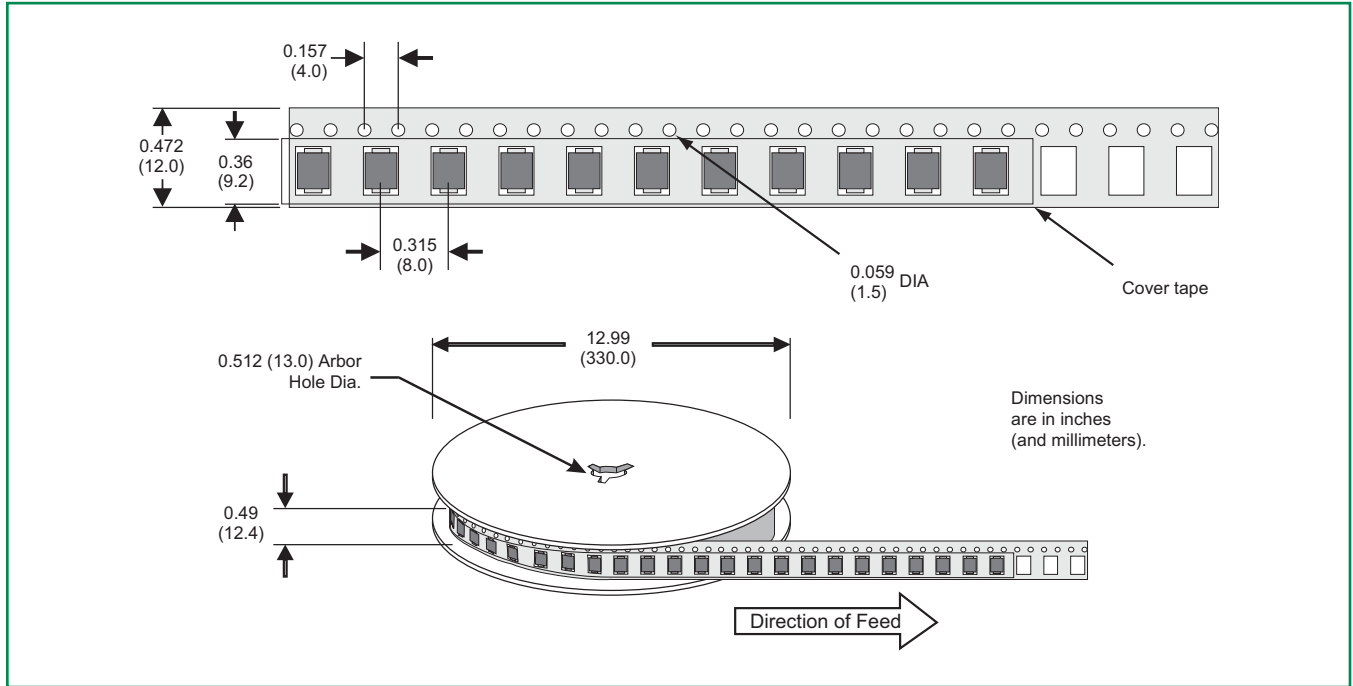
Dimension	Inches		Millimeters	
	Min	Max	Min	Max
A	0.140	0.155	3.56	3.94
B	0.205	0.220	5.21	5.59
C	0.077	0.083	1.96	2.11
D	0.166	0.180	4.22	4.57
E	0.036	0.063	0.91	1.60
F	0.066	0.083	1.67	2.11
G	0.004	0.008	0.10	0.20
H	0.077	0.086	1.96	2.18
J	0.043	0.053	1.09	1.35
K	0.008	0.012	0.20	0.30
L	0.039	0.049	0.99	1.24

Packing Options

Part Number	Marking	Package	Weight/ Unit	Packing Mode	Base Quantity	Quantity	
						Reel	Box
HTM-xxxRP	—	MINIMELF	0.040g	Tape & Reel	5000	2500	—
HT-xxxRP	—	DO35	0.150g	Tape & Reel	5000	5000	—
HT-xxx	—	DO35	0.150g	Bulk	5000	—	5000
ST-xxxRP	STxxx	DO214	0.075g	Tape & Reel	2500	2500	—

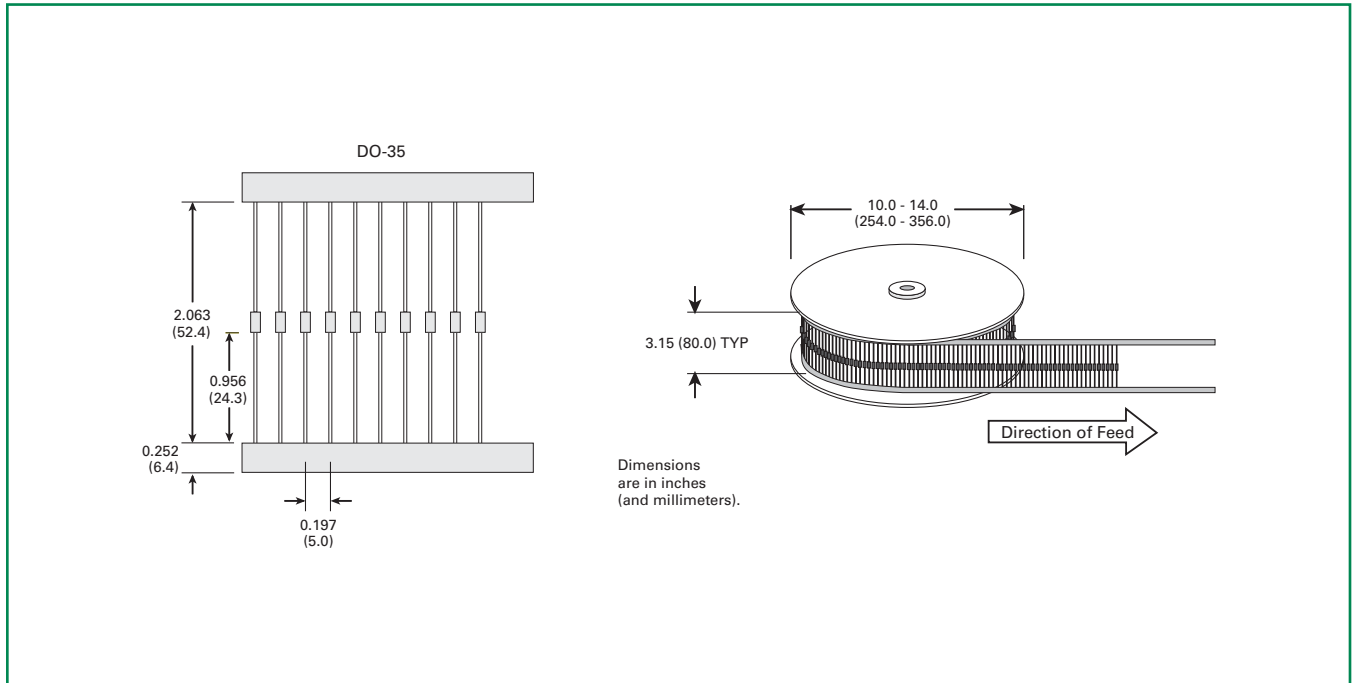
**DO-214 Embossed Carrier Reel Pack (RP) Specifications**

Meets all EIA-481-1 Standards

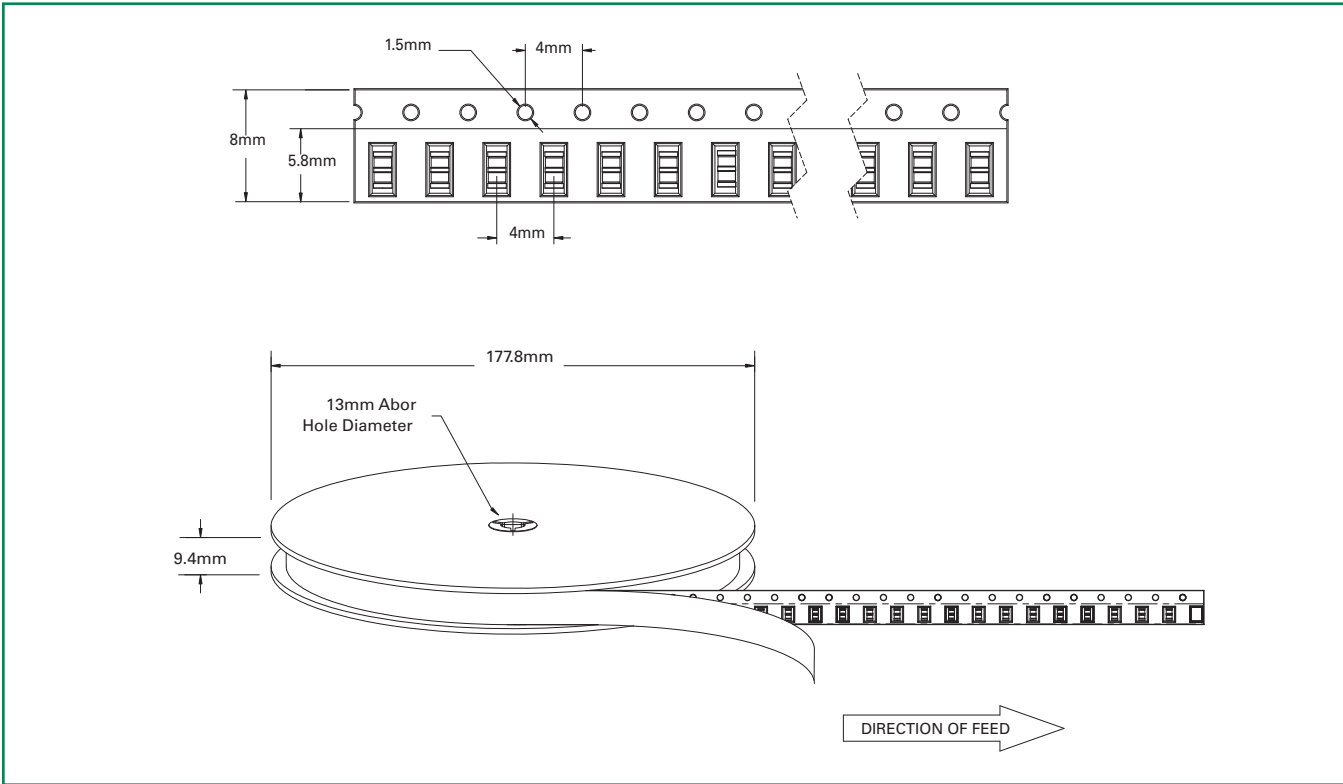


**DO-35 Reel Pack (RP) Specifications**

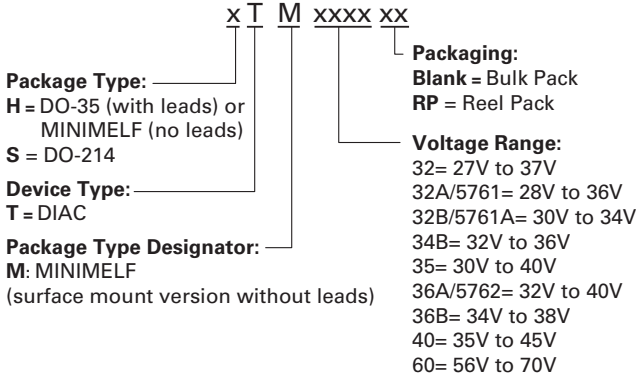
Meets all EIA-296 Standards



**MINIMELF Reel Pack (RP) Specifications**



**Part Numbering System**



**Part Marking System**

