

Cooper Bussmann

[Homepage](#)
[About Cooper Bussmann](#)
[Contact Us](#)
[Privacy](#)
[Legal](#)
[Cooper Bussmann® Brand](#)
[Site Map](#)



ATC-40
AUTOMOTIVE BLADE TYPE FUSE

Product Information

Product Type:	Fuse
Product Family:	Automotive

Recommended Products

Rec. Inline Fuse Holder:	HHD
--------------------------	---------------------

Electrical Properties

Maximum DC Voltage:	32
Amperage Rating:	40
DC Interrupting Ratings:	<ul style="list-style-type: none"> • 1000 at 32V
Fast Acting:	Yes

Blade-Type Automotive Fuses

ATC Series, Fast Acting

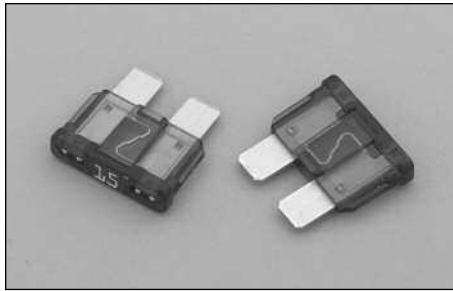

Dimensional Data

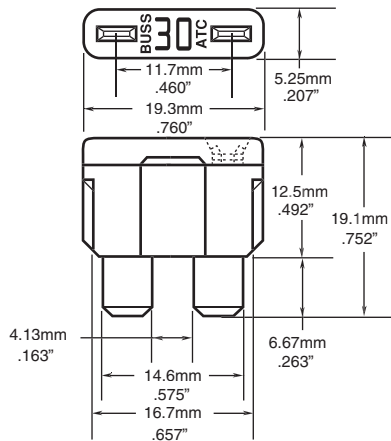

Catalog Symbol: ATC

Fast-Acting

Ampere Rating: 1 to 40 Amperes

Interrupting Rating: 1,000 Amperes

Agency Approvals: U.L. Recognized, (3-40A)

Guide JFHR2, File E56412

Ordering: Specify packaging and product code

Time-Current Characteristic Curves—Average Melt

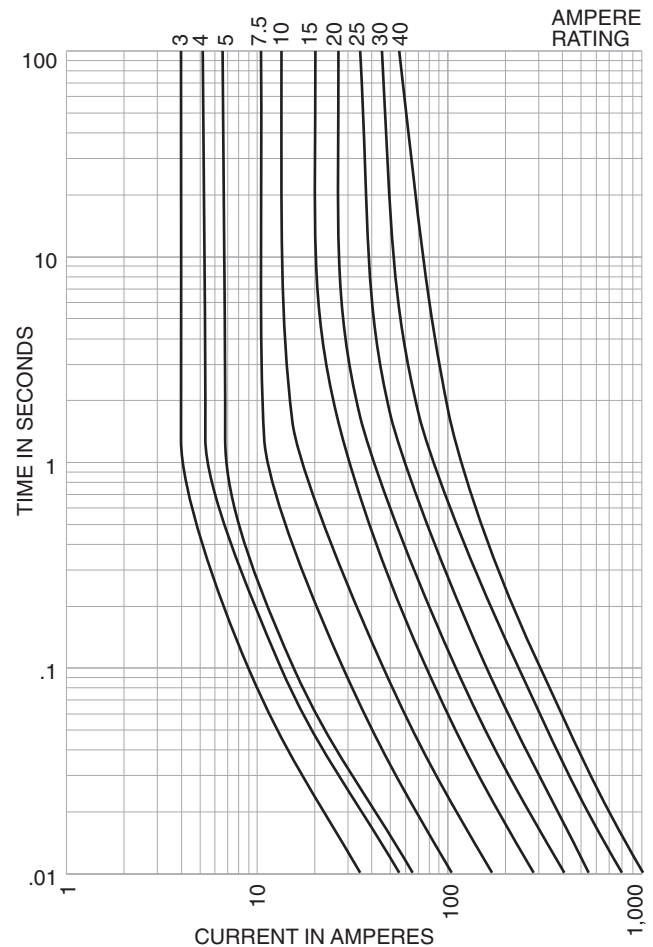

SPECIFICATIONS

Product Code	Body Color	Voltage Rating DC
ATC-1	Black	32V
ATC-2	Gray	32V
ATC-3	Violet	32V
ATC-4	Pink	32V
ATC-5	Tan	32V
ATC-7 1/2	Brown	32V
ATC-10	Red	32V
ATC-15	Blue	32V
ATC-20	Yellow	32V
ATC-25	Clear	32V
ATC-30	Green	32V
ATC-40	Amber	32V

Recommended Bussmann Fuseholders*

Blade-Type	Part	Description	Fuse Size	Wire Size
	HHC	Yellow Fuseholder	3-20 Amps	#16 Lead Wire
	HHF	Black Fuseholder w/cover	3-20 Amps	#14 Lead Wire
ATC	HHD	Black Fuseholder	3-30 Amps	#12 Lead Wire
	HHG	Black Fuseholder w/cover	3-30 Amps	#12 Lead Wire
	HHD-C	Cover Only	—	—

*Also used in Bussmann 1A5600 Fuse Clips (0-20A)

PACKAGING CODE

Packaging Code	Description
Blank	5 pieces of fuses packed in a tin
BK	2,000 pieces of fuses packed in a carton