

FEATURES

Ultralow offset voltage

$T_A = 25^\circ\text{C}$, 25 μV maximum

Outstanding offset voltage drift 0.1 $\mu\text{V}/^\circ\text{C}$ maximum

Excellent open-loop gain and gain linearity

12 $\text{V}/\mu\text{V}$ typical

CMRR: 130 dB minimum

PSRR: 115 dB minimum

Low supply current 2.0 mA maximum

Fits industry-standard precision op amp sockets

GENERAL DESCRIPTION

The OP177 features one of the highest precision performance of any op amp currently available. Offset voltage of the OP177 is only 25 μV maximum at room temperature. The ultralow V_{OS} of the OP177 combines with its exceptional offset voltage drift (TCV_{OS}) of 0.1 $\mu\text{V}/^\circ\text{C}$ maximum to eliminate the need for external V_{OS} adjustment and increases system accuracy over temperature.

The OP177 open-loop gain of 12 $\text{V}/\mu\text{V}$ is maintained over the full $\pm 10 \text{ V}$ output range. CMRR of 130 dB minimum, PSRR of 120 dB minimum, and maximum supply current of 2 mA are just a few examples of the excellent performance of this

operational amplifier. The combination of outstanding specifications of the OP177 ensures accurate performance in high closed-loop gain applications.

This low noise, bipolar input op amp is also a cost effective alternative to chopper-stabilized amplifiers. The OP177 provides chopper-type performance without the usual problems of high noise, low frequency chopper spikes, large physical size, limited common-mode input voltage range, and bulky external storage capacitors.

The OP177 is offered in the -40°C to $+85^\circ\text{C}$ extended industrial temperature ranges. This product is available in 8-lead PDIP, as well as the space saving 8-lead SOIC.

PIN CONFIGURATION

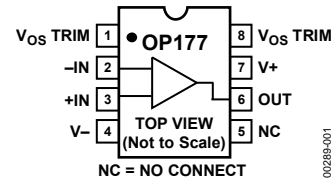

Figure 1. 8-Lead PDIP (P-Suffix),
8-Lead SOIC (S-Suffix)

FUNCTIONAL BLOCK DIAGRAM

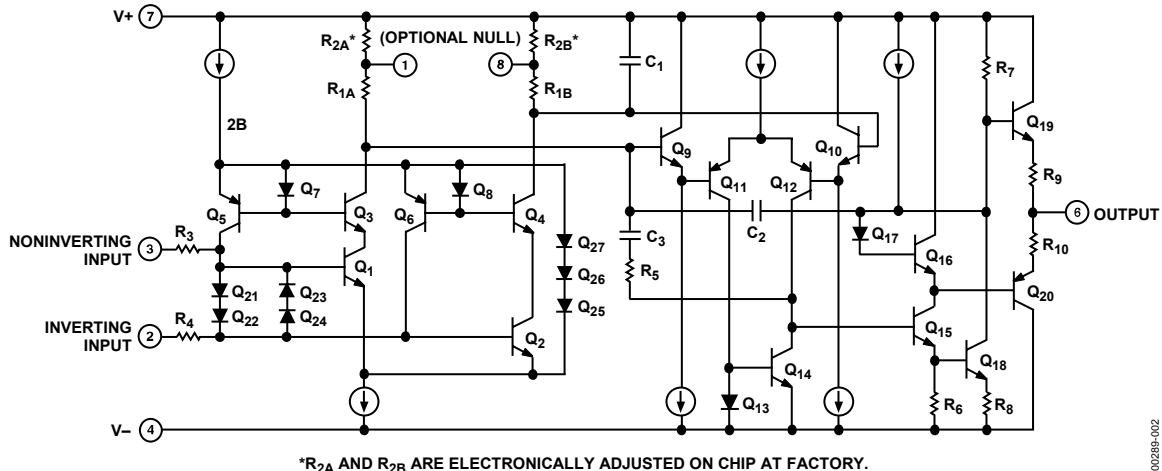

Figure 2. Simplified Schematic

SPECIFICATIONS

ELECTRICAL CHARACTERISTICS

@ $V_S = \pm 15\text{ V}$, $T_A = 25^\circ\text{C}$, unless otherwise noted.

Table 1.

Parameter	Symbol	Conditions	OP177F			OP177G			Unit
			Min	Typ	Max	Min	Typ	Max	
INPUT OFFSET VOLTAGE	V_{OS}		10	25		20	60	μV	
LONG-TERM INPUT OFFSET ¹ Voltage Stability	$\Delta V_{OS}/\text{time}$		0.3			0.4		$\mu\text{V}/\text{mo}$	
INPUT OFFSET CURRENT	I_{OS}		0.3	1.5		0.3	2.8	nA	
INPUT BIAS CURRENT	I_B		-0.2	+1.2	+2	-0.2	+1.2	+2.8	nA
INPUT NOISE VOLTAGE	e_n	$f_0 = 1\text{ Hz to }100\text{ Hz}^2$	118	150		118	150	nV rms	
INPUT NOISE CURRENT	i_n	$f_0 = 1\text{ Hz to }100\text{ Hz}^2$	3	8		3	8	pA rms	
INPUT RESISTANCE Differential Mode ³	R_{IN}		26	45		18.5	45	$\text{M}\Omega$	
INPUT RESISTANCE COMMON MODE	R_{INCM}		200			200		$\text{G}\Omega$	
INPUT VOLTAGE RANGE ⁴	IVR		± 13	± 14		± 13	± 14	V	
COMMON-MODE REJECTION RATIO	CMRR	$V_{CM} = \pm 13\text{ V}$	130	140		115	140	dB	
POWER SUPPLY REJECTION RATIO	PSRR	$V_S = \pm 3\text{ V to } \pm 18\text{ V}$	115	125		110	120	dB	
LARGE SIGNAL VOLTAGE GAIN	A_{VO}	$R_L \geq 2\text{ k}\Omega$, $V_O = \pm 10\text{ V}^5$	5000	12,000		2000	6000	V/mV	
OUTPUT VOLTAGE SWING	V_O	$R_L \geq 10\text{ k}\Omega$	± 13.5	± 14.0		± 13.5	± 14.0	V	
		$R_L \geq 2\text{ k}\Omega$	± 12.5	± 13.0		± 12.5	± 13.0	V	
		$R_L \geq 1\text{ k}\Omega$	± 12.0	± 12.5		± 12.0	± 12.5	V	
SLEW RATE ²	SR	$R_L \geq 2\text{ k}\Omega$	0.1	0.3		0.1	0.3	V/ μs	
CLOSED-LOOP BANDWIDTH ²	BW	$A_{VCL} = 1$	0.4	0.6		0.4	0.6	MHz	
OPEN-LOOP OUTPUT RESISTANCE	R_O		60			60		Ω	
POWER CONSUMPTION	P_D	$V_S = \pm 15\text{ V}$, no load	50	60		50	60	mW	
		$V_S = \pm 3\text{ V}$, no load	3.5	4.5		3.5	4.5	mW	
SUPPLY CURRENT	I_{SY}	$V_S = \pm 15\text{ V}$, no load	1.6	2		1.6	2	mA	
OFFSET ADJUSTMENT RANGE		$R_P = 20\text{ k}\Omega$	± 3			± 3		mV	

¹ Long-term input offset voltage stability refers to the averaged trend line of V_{OS} vs. time over extended periods after the first 30 days of operation. Excluding the initial hour of operation, changes in V_{OS} during the first 30 operating days are typically less than 2.0 μV .

² Sample tested.

³ Guaranteed by design.

⁴ Guaranteed by CMRR test condition.

⁵ To ensure high open-loop gain throughout the $\pm 10\text{ V}$ output range, A_{VO} is tested at $-10\text{ V} \leq V_O \leq 0\text{ V}$, $0\text{ V} \leq V_O \leq +10\text{ V}$, and $-10\text{ V} \leq V_O \leq +10\text{ V}$.

OP177

@ $V_S = \pm 15\text{ V}$, $-40^\circ\text{C} \leq T_A \leq +85^\circ\text{C}$, unless otherwise noted.

Table 2.

Parameter	Symbol	Conditions	OP177F			OP177G			Unit
			Min	Typ	Max	Min	Typ	Max	
INPUT									
Input Offset Voltage	V_{OS}			15	40		20	100	μV
Average Input Offset Voltage Drift ¹	TCV_{OS}			0.1	0.3		0.7	1.2	$\mu\text{V}/^\circ\text{C}$
Input Offset Current	I_{OS}			0.5	2.2		0.5	4.5	nA
Average Input Offset Current Drift ²	TCl_{OS}			1.5	40		1.5	85	$\text{pA}/^\circ\text{C}$
Input Bias Current	I_B		-0.2	+2.4	+4		+2.4	± 6	nA
Average Input Bias Current Drift ²	TCl_B			8	40		15	60	$\text{pA}/^\circ\text{C}$
Input Voltage Range ³	IVR		± 13	± 13.5		± 13	± 13.5		V
COMMON-MODE REJECTION RATIO	CMRR	$V_{CM} = \pm 13\text{ V}$	120	140		110	140		dB
POWER SUPPLY REJECTION RATIO	PSRR	$V_S = \pm 3\text{ V to } \pm 18\text{ V}$	110	120		106	115		dB
LARGE-SIGNAL VOLTAGE GAIN ⁴	A_{VO}	$R_L \geq 2\text{ k}\Omega, V_O = \pm 10\text{ V}$	2000	6000		1000	4000		V/mV
OUTPUT VOLTAGE SWING	V_O	$R_L \geq 2\text{ k}\Omega$	± 12	± 13		± 12	± 13		V
POWER CONSUMPTION	P_D	$V_S = \pm 15\text{ V}$, no load		60	75		60	75	mW
SUPPLY CURRENT	I_{SY}	$V_S = \pm 15\text{ V}$, no load		20	2.5		2	2.5	mA

¹ TCV_{OS} is sample tested.

² Guaranteed by endpoint limits.

³ Guaranteed by CMRR test condition.

⁴ To ensure high open-loop gain throughout the $\pm 10\text{ V}$ output range, A_{VO} is tested at $-10\text{ V} \leq V_O \leq 0\text{ V}$, $0\text{ V} \leq V_O \leq +10\text{ V}$, and $-10\text{ V} \leq V_O \leq +10\text{ V}$.

TEST CIRCUITS

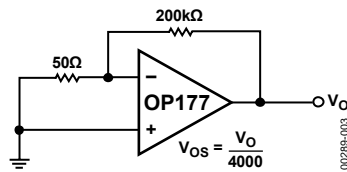

Figure 3. Typical Offset Voltage Test Circuit

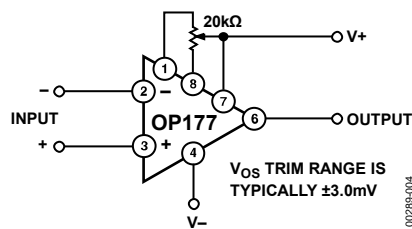

Figure 4. Optional Offset Nulling Circuit

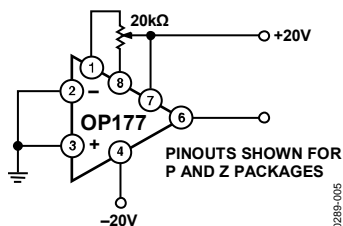

Figure 5. Burn-In Circuit

ABSOLUTE MAXIMUM RATINGS

Table 3.

Parameter	Ratings
Supply Voltage	±22 V
Internal Power Dissipation ¹	500 mW
Differential Input Voltage	±30 V
Input Voltage	±22 V
Output Short-Circuit Duration	Indefinite
Storage Temperature Range	−65°C to +125°C
Operating Temperature Range	−40°C to +85°C
Lead Temperature (Soldering, 60 sec)	300°C
DICE Junction Temperature (T _j)	−65°C to +150°C

¹ For supply voltages less than ±22 V, the absolute maximum input voltage is equal to the supply voltage.

Stresses above those listed under Absolute Maximum Ratings may cause permanent damage to the device. This is a stress rating only; functional operation of the device at these or any other conditions above those indicated in the operational section of this specification is not implied. Exposure to absolute maximum rating conditions for extended periods may affect device reliability.

THERMAL RESISTANCE

θ_{JA} is specified for worst-case mounting conditions, that is, θ_{JA} is specified for device in socket for PDIP; θ_{JA} is specified for device soldered to printed circuit board for SOIC package.

Table 4. Thermal Resistance

Package Type	θ_{JA}	θ_{JC}	Unit
8-Lead PDIP (P-Suffix)	103	43	°C/W
8-Lead SOIC (S-Suffix)	158	43	°C/W

ESD CAUTION

ESD (electrostatic discharge) sensitive device. Electrostatic charges as high as 4000 V readily accumulate on the human body and test equipment and can discharge without detection. Although this product features proprietary ESD protection circuitry, permanent damage may occur on devices subjected to high energy electrostatic discharges. Therefore, proper ESD precautions are recommended to avoid performance degradation or loss of functionality.



OUTLINE DIMENSIONS

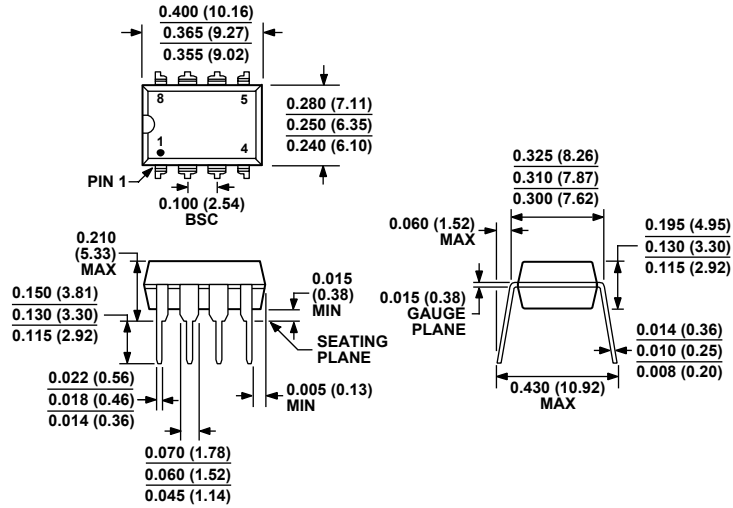

COMPLIANT TO JEDEC STANDARDS MS-001-BA
 CONTROLLING DIMENSIONS ARE IN INCHES; MILLIMETER DIMENSIONS (IN PARENTHESES) ARE ROUNDED-OFF INCH EQUIVALENTS FOR REFERENCE ONLY AND ARE NOT APPROPRIATE FOR USE IN DESIGN. CORNER LEADS MAY BE CONFIGURED AS WHOLE OR HALF LEADS.

Figure 33. 8-Lead Plastic Dual In-Line Package (PDIP)
 P-Suffix
 (N-8)
 Dimensions show in inches and (millimeters)

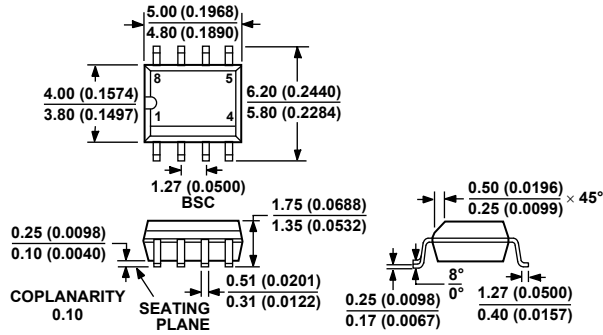

COMPLIANT TO JEDEC STANDARDS MS-012-AA
 CONTROLLING DIMENSIONS ARE IN MILLIMETERS; INCH DIMENSIONS (IN PARENTHESES) ARE ROUNDED-OFF MILLIMETER EQUIVALENTS FOR REFERENCE ONLY AND ARE NOT APPROPRIATE FOR USE IN DESIGN.

Figure 34. 8-Lead Standard Small Outline Package (SOIC_N)
 S-Suffix
 (R-8)
 Dimensions shown in millimeters and (inches)

OP177

ORDERING GUIDE

Model	Temperature Range	Package Description	Package Option
OP177FP	-40°C to +85°C	8-Lead PDIP	P-Suffix (N-8)
OP177FPZ ¹	-40°C to +85°C	8-Lead PDIP	P-Suffix (N-8)
OP177GP	-40°C to +85°C	8-Lead PDIP	P-Suffix (N-8)
OP177GPZ ¹	-40°C to +85°C	8-Lead PDIP	P-Suffix (N-8)
OP177FS	-40°C to +85°C	8-Lead SOIC_N	S-Suffix (R-8)
OP177FS-REEL	-40°C to +85°C	8-Lead SOIC_N	S-Suffix (R-8)
OP177FS-REEL7	-40°C to +85°C	8-Lead SOIC_N	S-Suffix (R-8)
OP177FSZ ¹	-40°C to +85°C	8-Lead SOIC_N	S-Suffix (R-8)
OP177FSZ-REEL ¹	-40°C to +85°C	8-Lead SOIC_N	S-Suffix (R-8)
OP177FSZ-REEL7 ¹	-40°C to +85°C	8-Lead SOIC_N	S-Suffix (R-8)
OP177GS	-40°C to +85°C	8-Lead SOIC_N	S-Suffix (R-8)
OP177GS-REEL	-40°C to +85°C	8-Lead SOIC_N	S-Suffix (R-8)
OP177GS-REEL7	-40°C to +85°C	8-Lead SOIC_N	S-Suffix (R-8)
OP177GSZ ¹	-40°C to +85°C	8-Lead SOIC_N	S-Suffix (R-8)
OP177GSZ-REEL ¹	-40°C to +85°C	8-Lead SOIC_N	S-Suffix (R-8)
OP177GSZ-REEL7 ¹	-40°C to +85°C	8-Lead SOIC_N	S-Suffix (R-8)

¹ Z = Pb-free part.