

**Cooper Bussmann**

[Homepage](#)  
[About Cooper Bussmann](#)  
[Contact Us](#)  
[Privacy](#)  
[Legal](#)  
[Cooper Bussmann® Brand](#)  
[Site Map](#)



**GBB-8**

Very Fast Acting, 1/4 X 1-1/4 Inch, Ceramic Tube Fuse

**Product Information**

Product Type:	Fuse
Product Family:	Electronic
Brand:	Cooper Bussmann

**Recommended Products**

Rec. Fuse Block:	<a href="#">S-8000 Series</a>
Rec. Inline Fuse Holder:	<a href="#">HRK</a>
Rec. Panel-mount Fuse Holder:	<a href="#">HTB Series</a>
Rec. Fuse Clips:	<a href="#">1A1907 Series</a>

**Physical Properties**

Dimensions:	1.25in.(L) × 0.25in.(W) × 0in.(H)
-------------	-----------------------------------

**Certifications**

- [UL Recognized](#)
- [CSA Component Accepted](#)

**Electrical Properties**

Maximum AC Voltage:	250
Maximum DC Voltage:	125
Amperage Rating:	8
AC Interrupting Ratings:	<ul style="list-style-type: none"> <li>• 200 at 250V</li> <li>• 10000 at 125V</li> </ul>
DC Interrupting Ratings:	<ul style="list-style-type: none"> <li>• 10000</li> </ul>
Fast Acting:	Yes
Resistance:	0.0136

# 1/4" x 1 1/4" Fuses

## GBB Series, Very Fast-Acting, Ceramic Tube

### Description

- Very fast-acting
- Optional axial leads available
- 1/4" x 1 1/4" (6.3 x 32mm) physical size
- Ceramic tube, nickel-plated brass endcap construction
- 100pc-carton quantity weighs 1.0 lb (0.45 kg)
- UL Recognized product meets standard 248-14

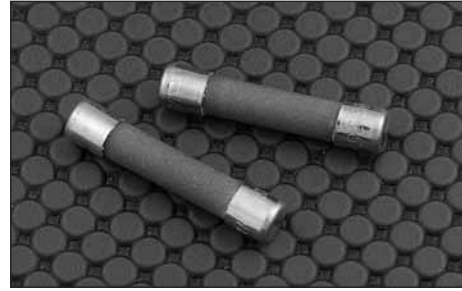

Electrical Characteristics		
Rated Current	% of Amp Rating	Opening Time
1 - 20A	100%	None
	150%	2 minutes maximum
	250%	1 seconds maximum
	400%	-
25, 30A	100%	None
	150%	2 minutes maximum
	250%	6 seconds maximum
	400%	-

### Agency Information

- UL Recognized Card: GBB 1-30A (JFHR2, E56412)
- CSA Component Certified Card (Class 1422-01 File 53787)

### Ordering

- Specify packaging, product, and option code

### Dimensions - mm/in

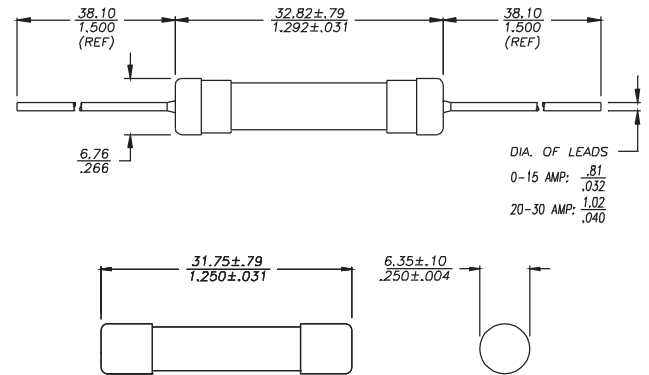

Product Code	Specifications						
	Voltage Rating		AC Interrupting Rating (amps)*		DC Interrupting Rating (amps)*	Typical DC Cold Resistance (Ω)**	Typical Voltage Drop (V)‡
	Vac	Vdc	250Vac	125Vac	125Vdc		
GBB-1-R	250	125	200	10,000	10,000	0.17750	0.2096
GBB-1-1/4-R	250	125	200	10,000	10,000	0.17900	0.2497
GBB-2-R	250	125	200	10,000	10,000	0.06620	0.1687
GBB-3-R	250	125	200	10,000	10,000	0.04475	0.1816
GBB-4-R	250	125	200	10,000	10,000	0.03175	0.1778
GBB-5-R	250	125	200	10,000	10,000	0.02125	0.1217
GBB-6-R	250	125	200	10,000	10,000	0.01800	0.1324
GBB-7-R	250	125	200	10,000	10,000	0.01550	0.1355
GBB-8-R	250	125	200	10,000	10,000	0.01360	0.1144
GBB-9-R	250	125	200	10,000	10,000	0.01070	0.1218
GBB-10-R	250	125	200	10,000	10,000	0.00934	0.0877
GBB-12-R	250	125	200	10,000	10,000	0.00620	0.0806
GBB-15-R	250	125	200	10,000	10,000	0.00472	0.0735
GBB-20-R	250	125	200	200	200	0.00330	0.0728
GBB-25-R	250	125	200	200	200	0.00252	0.0610
GBB-30-R	250	125	200	200	200	0.00206	0.0657

\* Interrupting ratings: Interrupting ratings for 1-15A at 125Vdc was measured at 10,000A, 3.5 ms maximum, with time constant. Ratings 20-30A at 125Vdc were measured at 200A, 0.5 ms maximum, with time constant. Ratings 1-15A at 125Vac were measured at 10,000A, and 70% - 80% power factor. The interrupting ratings for 1-30A at 250Vac were measured at 90% - 100% power factor.

\*\* DC Cold Resistance (Measured at <10% of rated current)

† Typical Melting I<sub>t</sub> (I<sub>t</sub> was measured at listed interrupting rating and rated voltage) Interrupting ratings were measured at 70% to 80% power factor on AC.

‡ Typical Voltage drop (Voltage drop was measured at 25°C±3°C ambient temperature at rated current)

# Time-Current Curve

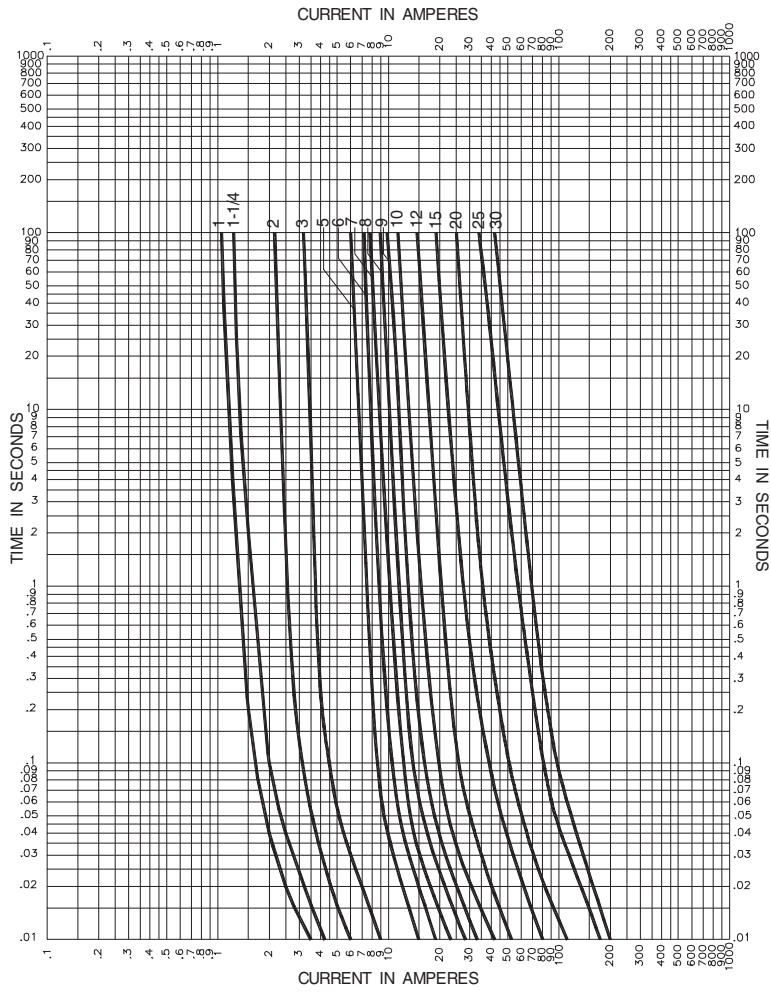

Packaging	
Packaging Code	Description
BK	100 fuses packed into a cardboard carton
BK1	1,000 fuses packed into a cardboard carton

Option Code	
Option Code	Description
B	Board Washable - Hermetically sealed to withstand aqueous cleaning
V	Axial leads - copper tinned wire with nickel plated brass overcaps