

QOU Miniature Circuit Breakers and Switches Unit Mount (Cable-in/Cable-out)

Class 720

Catalog
September

2005

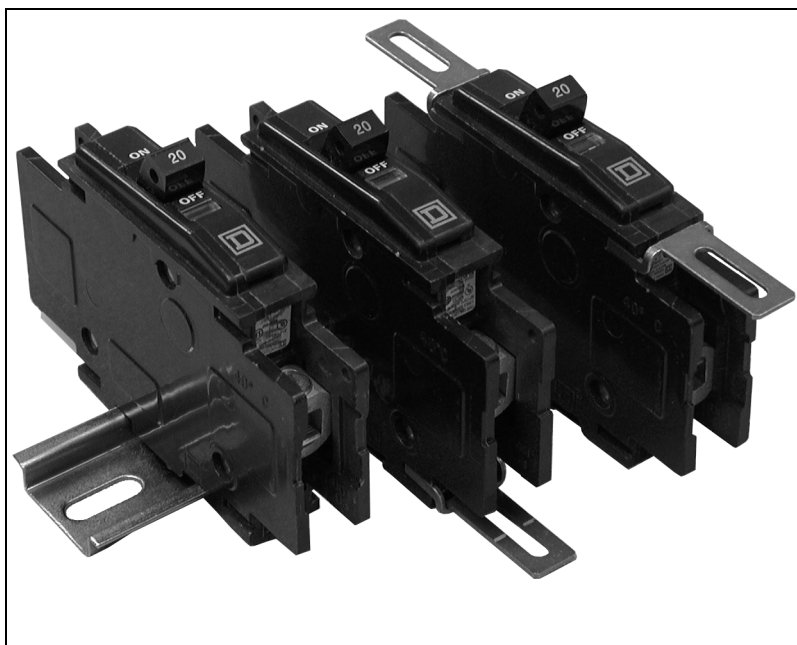

CONTENTS

Description	Page
Application Information	page 2
Accessories	page 12
UL Requirements	page 17
Circuit Breaker Tripping Characteristics (Trip Curves)	page 19
Dimensions	page 28
QYU One-Pole 277 Vac Supplementary Protectors	page 30

QOU Miniature Circuit Breakers and Switches

Application Information

APPLICATION INFORMATION

QOU Miniature Circuit Breaker Types

Miniature molded case circuit breakers are intended for use in residential and commercial applications. They are tested and listed according to UL Standard 489 and CSA Standard C22.2 No. 5-02 for molded case circuit breakers and enclosures.

QOU miniature circuit breakers are unit-mount (lug/lug) thermal-magnetic circuit breakers which:

- Provide a means to manually open a circuit.
- Automatically open a circuit under overload or short circuit conditions.
- Feature common tripping of all poles.
- Have a Visi-Trip® trip indicator.
- Can be flush-, surface-, or DIN rail-mounted.
- Has lugs at both ends (cable-in/cable-out construction)
- Operate in any position.
- Are fully tested, UL Listed, and CSA certified for reverse connection without restrictive line/load markings.

Non-automatic Switches

QOU non-automatic switches are intended for use as disconnect devices only. UL Standard 489 requires switches to be protected by a thermal-magnetic circuit breaker (or fuse) of equivalent rating. QOU switches are UL Listed for use on circuits capable of delivering not more than 10,000 amperes when protected by an equivalent rated circuit breaker or fuse. QOU switches contain no automatic tripping mechanisms and do not provide overcurrent protection.

Description

QOU miniature circuit breakers and switches are available for surface-, flush-, or DIN rail mounted applications in one-, two-, and three-pole constructions. QOU miniature circuit breakers are used for overcurrent protection and switching on both ac and dc electrical systems. QOU circuit breakers and switches measure 0.75 in. (19 mm) wide per pole. Two- and three-pole circuit breakers are both equipped with an internal crossbar for common tripping of all poles. QOU switches are available in one-pole, 60 ampere and two- and three-pole, 60, 100 and 125 ampere construction.

Cases for QOU miniature circuit breakers and switches are constructed of a glass-reinforced insulating material that provides high dielectric strength. Current carrying components are isolated from the handle. The handle position indicates whether the circuit breaker is off, on or tripped.

Applications

One-pole QOU miniature circuit breakers rated 120/240 Vac are UL Listed for use on 120/240 Vac single-phase, three-wire or 208Y/120 Vac three-phase, four-wire electrical systems.

Two-pole QOU circuit breakers rated 120/240 Vac are UL Listed for use on 120/240 Vac single-phase, three-wire or 208Y/120 Vac three-phase, four-wire electrical systems. They cannot be used on 240 Vac delta systems. Use QOU-H two-pole circuit breakers rated 240 Vac on 240 Vac delta and 240 Vac single-phase, two wire systems.

Three-pole QOU circuit breakers rated 240 Vac are UL Listed for use on any system where the maximum phase-to-phase or phase-to-ground voltage is 240 Vac or less.

For application information on other systems, contact your local field office

QOU Miniature Circuit Breakers and Switches Application Information

Table 1: Selection Data

Catalog Number								Terminal Lug Wire Size (AWG)
Rating	One-Pole		Two-Pole			Three-Pole		
	120/240 Vac		120/240 Vac	240 Vac	120/240 Vac	240 Vac		
	10K AIR	22K AIR	10 K AIR		22K AIR	10K AIR		
10 A	QOU110	—	QOU210	—	—	QOU310	1—#14—#2 Cu or Al	
15 A	QOU115*	QOU115VH	QOU215*	QOU215H*	QOU215VH	QOU315*		
15 A	QOU115HM*†	—	—	—	—	—		
20 A	QOU120*	QOU120VH	QOU220*	QOU220H*	QOU220VH	QOU320*		
20 A	QOU120HM*†	—	—	—	—	—		
25 A	QOU125*	QOU125VH	QOU225*	QOU225H*	QOU225VH	QOU325*		
30 A	QOU130*	QOU130VH	QOU230*	QOU230H*	QOU230VH	QOU330*		
35 A	QOU135*	QOU135VH	QOU235*	—	QOU235VH	QOU335*		
40 A	QOU140*	QOU140VH	QOU240*	—	QOU240VH	QOU340*		
45 A	QOU145*	QOU145VH	QOU245*	—	QOU245VH	QOU345*		
50 A	QOU150*	QOU150VH	QOU250*	—	QOU250VH	QOU350*		
60 A	QOU160*	QOU160VH	QOU260*	—	QOU260VH	QOU360*		
70 A	QOU170*	—	QOU270*	—	—	QOU370‡		1—#12—#2/0 Cu or Al
80 A	QOU180‡	—	QOU280‡	—	—	QOU380‡		
90 A	QOU190‡	—	QOU290‡	—	—	QOU390‡		
100 A	QOU1100‡	—	QOU2100‡	—	—	QOU3100‡		
125 A	—	—	QOU2125‡	—	—	—		
Switch—60 Amperes Max.—240 Vac				QOU200	—	QOU300	1—#14—#2	
Switch—100 Amperes Max.—240 Vac				QOU2000‡	—	QOU3000‡	1—#12—#2/0	
Switch—125 Amperes Max.—240 Vac				QOU20001‡	—	QOU30001‡	1—#12—#2/0	

* UL Listed as HACR type for use with heating, air conditioning and refrigeration equipment containing motor-group combinations and marked for use with HACR type circuit breakers.

† High-magnetic trip circuit breakers. Recommended for applications where high initial inrush current can occur and for individual dimmer applications.

‡ Available as Series 1 with forward box lugs only. (No optional terminations)

Tripping Mechanisms

A tripping mechanism is an assembly within the circuit breaker molded case that causes the circuit breaker to open automatically under sustained overload or short circuit conditions.

The tripping mechanisms in two- and three-pole circuit breakers operate such that an overcurrent on any pole of the circuit breaker will cause all poles of the circuit breaker to open simultaneously. Thermal and magnetic factory calibration (with current) is performed on each pole of every Square D circuit breaker.

These mechanisms operate to trip the circuit breaker:

- Thermal trip
- Magnetic trip
- Optional shunt trip accessory (see Accessories, page 12)

The sensing system is an integral part of a thermal-magnetic circuit breaker. The sensing system continually monitors current flowing through the circuit breaker. It detects abnormal current conditions and, depending on the magnitude of the current, initiates an inverse-time or an instantaneous tripping response. This action causes the tripping mechanism to open the circuit breaker contacts and interrupt current flow. The speed of the tripping process must be controllable and inversely matched to the severity of the overcurrent. QOU miniature circuit breakers have an over-center toggle mechanism for quick-make, quick-break action with positive handle indication. The handle assumes a position between ON (I) and OFF (O) when the circuit breaker has tripped.

QOU Miniature Circuit Breakers and Switches

Application Information

Thermal Trip

The thermal trip element of a circuit breaker is a root-mean-squared (rms) current sensing device. The thermal element, or bimetal, is constructed from metals with dissimilar rates of expansion bonded together. The thermal element responds to overloads by reacting to the heat generated both by the current flowing through the circuit breaker and by the heat contribution from ambient conditions. The bending force of the bimetal causes the circuit breaker to trip (see Figure 1). The deflection of the bimetal is predictable as a function of current and time. This is the inverse time tripping characteristic of the thermal element, i.e., the tripping time decreases as the magnitude of the current increases.

Square D calibrates the thermal elements and they are not field-adjustable. The thermal trip elements are calibrated for 40° C (104° F) ambient temperature, per UL Standard 489 and CSA Standard C22.2 No. 5-02.

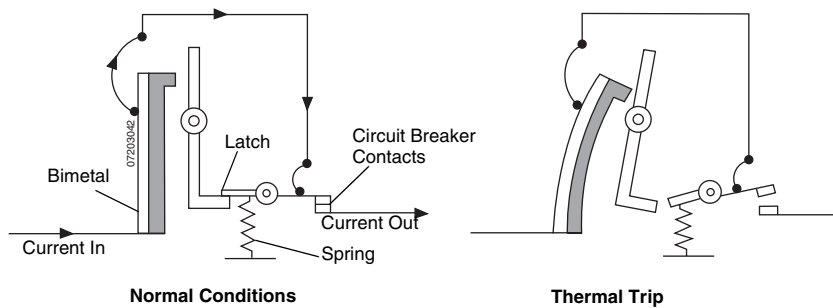

Figure 1: Thermal Tripping

Magnetic Trip

The magnetic (instantaneous) trip element uses an electromagnetic assembly to trip the circuit breaker instantaneously (with no intentional delay) at or above a predetermined current value. During a short circuit of sufficient magnitude, the high-level current passing through the conductor rapidly increases the magnetic field of the electromagnet that attracts the armature. As the armature is drawn toward the electromagnet, it initiates an unlatching action and opens the circuit breaker contact (see Figure 2).

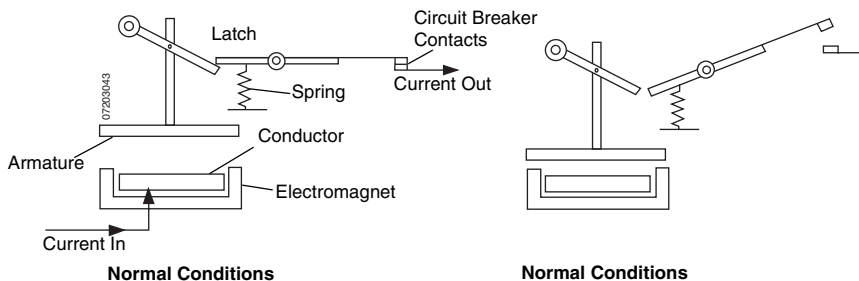

Figure 2: Magnetic Tripping

Trip Indicator

When the QOU miniature circuit breaker is tripped, the handle assumes a position between ON (I) and OFF (O) and the red Visi-Trip® indicator (A) appears in a window in the circuit breaker case. Reset the circuit breaker and Visi-Trip indicator by pushing the handle to OFF and then to ON.

QOU Miniature Circuit Breakers and Switches

Application Information

Line and Load Connections

QOU miniature circuit breakers are supplied with two types of lug configuration as standard, depending on the continuous current rating:

- 10–70 ampere one- and two-pole; reversible lugs
- 10–60 ampere three-pole; reversible lugs
- Other ampere ratings; forward lugs only

The box-type lugs supplied on QOU miniature circuit breakers are UL Listed and CSA certified to accept solid or stranded, aluminum or copper conductors. These lugs are UL Listed to be used with wire rated at 140° F, 167° F and 194° F (60° C, 75° C and 90° C), sized according to the NEC 176° F (75° C) temperature rating. See the Accessories section for more information on terminations.

Optional terminations, such as quick connectors, are also available. See the Accessories section for more information on terminations.

Ring-tongue terminals can be factory ordered using the following catalog number designations:

- QOU_ _ _3100 (ring-tongue terminal wired from front)
- QOUR_ _ _5283 (ring-tongue terminal wired from rear)

Mounting Provisions

QOU miniature circuit breakers are supplied with mounting brackets for both line and load side support. Mounting brackets are field installable and can be attached to the front or back of the circuit breaker molded case. See the Accessories section for more information on mounting brackets. Tapped mounting feet can be ordered using the catalog number designation QOU_ _ _3100.

All QOU miniature circuit breakers also come equipped with slots in the molded case for DIN rail mounting.

These miniature circuit breakers are designed for use with a standard 35 mm DIN mounting rail (DIN/EU 50 022, 0.30 x 1.38 in. [7.5 mm x 35 mm]).

Standards

Square D brand QOU miniature circuit breakers are manufactured and tested according to the following standards:

- UL Standard 489 (File E84967)
- NEMA Standard AB1
- Canadian Standards Association CSA C22.2 No. 5-02
- IEC 60947-2
- CE

Square D brand QOU non-automatic switches comply with:

- UL Standard 489
- Canadian Standards Association CSA C22.2 No. 5-02

NOTE: Circuit breakers are to be applied by guidelines detailed in the NEC and other applicable electrical codes.

QOU Miniature Circuit Breakers and Switches

Application Information

Catalog Numbers

Square D brand circuit breakers are ordered by a catalog number that includes the circuit breaker family, description, number of poles, amperage rating and suffix.

Table 2: Catalog Numbers

	Typical Catalog Number:					
	QO	U	2	30	H	2100
QO Miniature Circuit Breaker Family						
Description						
U – Unit Mounted (Lugs on Both Ends)						
No. of Poles						
1 – 1-pole						
2 – 2-pole						
3 – 3-pole						
Ampere Rating						
10–125 Ampere Rating						
00 = 60 A, 000 = 100 A, and 0001 - 125 A QOU Switch						
Rating						
1- and 2-pole	2-pole		3-pole			
No Letter-Standard 120/240 Vac Rating	VH - 22,000 AIR		No Letter - 240 Vac Rating			
VH - 22,000 AIR	H-240 Vac Rating		VH - 22,000 AIR			
Suffix						
XXX (i.e., 2100) - Indicates Factory-installed Accessory (See page 12)						

Ratings for QOU Miniature Circuit Breakers

When designing an electrical distribution system, overcurrent protective devices are generally selected based on performance requirements. Factors influencing this selection include system voltage, continuous current, interrupting rating and frequency.

QOU circuit breakers are selected by their ratings. A circuit breaker's rating must meet or exceed the parameters of the electrical system on which they are used.

Voltage Rating

A circuit breaker can be rated for alternating current (ac) or direct current (dc) or both. The established voltage rating of a circuit breaker is based on design parameters such as clearance of current carrying parts and dielectric withstand tests both through air and over surfaces. Voltage ratings indicate the maximum voltage for the electrical system on which the circuit breaker can be applied.

The circuit breaker must have a voltage rating greater than or equal to the system voltage. When a circuit breaker clears an overcurrent, it does so in two steps: First, the current sensing system identifies the overcurrent and releases the tripping mechanism. This results in a parting of the contacts. Then the circuit breaker must extinguish the voltage arc across the contacts. If the circuit breaker has the correct voltage rating, it can efficiently extinguish this voltage arc. QOU miniature circuit breakers are rated in the following UL 489 voltages, as shown in Table 3:

- 120/240 Vac
- 240 Vac
- 48 Vdc
- 60 Vdc
- 277 Vac for QYU, UL 1077 recognized supplementary protector only (not a branch circuit breaker)

QOU Miniature Circuit Breakers and Switches Application Information

Interrupting Rating

The interrupting rating of a circuit breaker is the highest current at rated voltage that the circuit breaker is intended to interrupt under standard test conditions. Circuit breakers must be chosen with interrupting ratings equal to or greater than the maximum available short-circuit current at the point where the circuit breaker is applied in the system (See Table 3).

Table 3: Interrupting Rating

Circuit Breaker Type	No. of Poles	Ampere Rating	UL Listed Interrupting Rating—RMS Sym. Amperes				
			AC Volts			DC Volts ¹	
			120/240	240	277	48	60
QOU	1	10–30	NA	NA	5 kA		
		10–70	10 kA	NA	NA	5 kA	NA
		80–100	10 kA	NA	NA	NA	5 kA
	2	10–70	10 kA	NA	NA	5 kA	NA
		80–125	10 kA	NA	NA	NA	5 kA
	3	10–70	NA	10 kA	NA	5 kA	NA
80–100		NA	10 kA	NA	NA	5 kA	
QOU-H	2	15–30	NA	10 kA	NA	5 kA	NA
QOU-VH	2	15–60	22 kA	NA	NA	5 kA	NA

NA = Not Applicable

¹ DC ratings do not apply to circuit breakers rated for 10 A

Continuous Current Rating

The continuous current rating of a circuit breaker is defined by the National Electrical Manufacturers Association (NEMA) as: "The maximum direct current or rms current, in amperes, at rated frequency which a device or assembly will carry continuously without exceeding the specified limits of observable temperature rise." Sometimes referred to as the ampere rating or handle rating of the circuit breaker, the continuous current rating relates to the system current flow under normal conditions.

UL Standard 489 states that circuit breakers must carry 100% of their continuous current rating indefinitely (without tripping) at 104° F (40° C) in free air. QOU circuit breakers should be applied, per the NEC, to carry 80% of their continuous current ratings in the intended enclosure. The continuous current rating is indicated on the handle of each circuit breaker. See Table 1.

Switching Duty

The switching duty (SWD) listing applies only to 15 A and 20 A circuit breakers rated at 277 Vac or less. The circuit breakers are subjected to specified temperature rise tests at predetermined periods during the endurance operations.

QOU Miniature Circuit Breakers and Switches

Application Information

UL HACR Type

HACR is an acronym that designates circuit breakers certified to be used on heating, air conditioning, and refrigeration loads. The 9th edition of UL489 eliminated special testing requirements for HACR certification, and the 2005 NEC eliminated the requirement for special HACR marking. HACR marking is no longer necessary for circuit breakers used in these applications in states and localities where the 2005 NEC has been adopted.

QOU circuit breakers will continue to carry the HACR marking to meet the requirements of previous NEC Sections 430 and 440 in areas where the 2005 NEC has not yet been adopted. In older versions of the NEC, Article 430-53(c) required that each circuit breaker must be of the inverse time type, and be approved for group installation. The 2005 NEC eliminated the group installation clause of this article.

The following QOU miniature circuit breakers will continue to carry the HACR label:

- 10–100 A, one-pole
- 10–125 A, two-pole
- 10–100 A, three-pole

High Magnetic

QOU-HM circuit breakers are recommended for area lighting (athletic fields, parking lots, outdoor signs, etc.) when using lamps of inherent high inrush current or individual dimmer applications, or other applications where high inrush current exceeds standard tripping conditions. These circuit breakers are available in 15 A and 20 A only.

QOU-HM circuit breakers are manufactured with the magnetic trip point calibrated at a much higher level than standard QOU circuit breakers. Table 4 lists the magnetic trip levels to which high-magnetic circuit breakers are calibrated:

Table 4: QOU-HM Circuit Breaker Magnetic Trip Levels

QOU-HM Circuit Breakers	Max. Full-Cycle Magnetic Hold Level	
15 A	21–35 x In	315–525 A
20 A	16–26 x In	322–537 A

QOU Miniature Circuit Breakers and Switches

Application Information

Ambient Temperature Rating

To meet the requirements of UL 489 and the Canadian Standards Association, thermal-magnetic circuit breakers are designed, built and calibrated for use on 50/60 Hz ac systems in a 104° F (40° C) ambient temperature. Time/current characteristic trip curves are drawn from actual test data that meets UL 489 testing requirements.

The ambient temperature is the temperature of the air surrounding the circuit breaker. Thermal-magnetic circuit breakers are temperature-sensitive devices, and their rated continuous current carrying capacity is based on a UL specified 104° F (40° C) calibration temperature. The ambient temperature can affect the performance characteristics of the circuit breaker. Thus, when applying a circuit breaker at temperatures other than 104° F (40° C), it is necessary to determine the circuit breaker's actual current carrying capacity under this condition. Further, it may be necessary to rerate the circuit breaker to compensate for these ambient conditions. See Figure 3:

Thermal-magnetic circuit breakers use bimetal strips that bend in response to temperature changes. Current flowing through the circuit breaker creates most of the heat that causes the tripping action. The ambient temperature surrounding the circuit breaker either adds to or subtracts from this available heat. Conductors are sized using the ampacity derating factors shown on the bottom of NEC Table 310-16 when designing systems for ambient temperatures other than 40° C.

Rerating of Thermal-magnetic Circuit Breakers for Ambient Conditions

Square D thermal-magnetic circuit breakers are to be applied in ambient temperatures within the range of 14° F to 140° F (-10° C to 60° C). Use the following rerating guidelines:

- Ambient Temperatures Between 77° F and 104° F (25° C and 40° C):
 - No rerating is necessary.
- Ambient Temperatures Between 14° F and 75° F (-10° C and 24° C):
 - Thermal-magnetic circuit breakers operating within this ambient temperature range will carry more than their continuous current rating without tripping. Conductor and equipment damage can result if they are not in the same low ambient environment as the circuit breaker.
 - Nuisance tripping will not be a problem. However, if closer protection of the equipment and conductor is required, the increased current carrying capacity of the circuit breaker at the lower ambient temperature should be taken into consideration.
- Ambient Temperatures Between 106° F and 140° F (41° C and 60° C):
 - Thermal-magnetic circuit breakers operating within this ambient temperature range will carry less than their continuous current rating and must be carefully selected to prevent nuisance tripping.

To determine the continuous current carrying capacity of a thermal-magnetic circuit breaker at an ambient temperature other than 104° F (40° C), perform the following steps:

1. Choose the ambient rerating curve in Figure 3 for the specific amperage rating of the circuit breaker you wish to apply. Note that the curve crosses the 104° F (40° C) ambient temperature line at the circuit breaker's rated continuous current carrying capacity (Circuit Breaker Handle Rating on the curve).
2. Follow this curve to the appropriate ambient temperature.
3. Read the adjusted continuous current carrying capacity at this point (on the left axis).
4. Add in any other applicable factors, such as continuous loading, per the NEC requirement.

QOU Miniature Circuit Breakers and Switches

Application Information

Figure 3: Ambient Derating of QOU Circuit Breaker

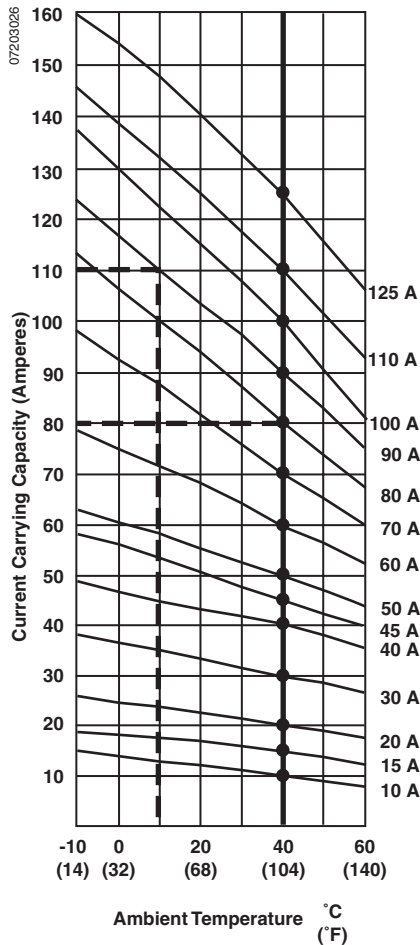

For example, Figure 3 shows the ambient derating curves for QOU miniature circuit breakers. What is the continuous current capacity of a 80 A circuit breaker applied at 104° F (40° C)? A 90 A circuit breaker at 50° F (10° C)?

By finding 40° C on the horizontal axis and reading up to the 80 A curve, you find that the circuit breaker will carry 80 A, which is its rated current carrying capacity. If the circuit breaker will be used on a continuous load (defined as three hours or more), Section 210-20(a) of the 2005 NEC requires that loading not exceed 80% of the rating. Here, $80 \text{ A} \times .80 = 64 \text{ A}$.

Locate 50° F (10° C) on the horizontal axis and move straight up to the 90 A curve. The circuit breaker will carry 110 A. Again, if the circuit is used on a continuous load, it must be applied at 80% of its rating. In this example the equation is $110 \text{ A} \times .80 = 88 \text{ A}$.

As explained in Section 210-20(a) of the NEC:

“Where a branch circuit supplies continuous loads or any combination of continuous and noncontinuous loads, the rating of the overcurrent device shall not be less than the noncontinuous load plus 125 percent of the continuous load.

“Exception: Where the assembly, including the overcurrent devices protecting the branch circuit(s), is listed for operation at 100 percent of its rating, the ampere rating of the overcurrent device shall be permitted to be not less than the sum of the continuous load plus the noncontinuous load.”

Frequency Rating

The standard-rated frequency for circuit breakers is 60 Hz, but Square D circuit breakers can be applied on 50 Hz systems without thermal or magnetic derating. Other frequencies can affect the thermal, magnetic and short-circuit tripping characteristics of circuit breakers.

Applying thermal-magnetic circuit breakers at frequencies above 50/60 Hz requires special consideration of the effects of high frequency on circuit breaker tripping characteristics. Thermal and magnetic operations must be treated separately.

Thermal Tripping Performance at High Frequency

At frequencies below 60 Hz, the thermal derating of thermal-magnetic circuit breakers is negligible. However, at frequencies above 60 Hz, thermal derating is required. High-frequency operation causes abnormal heat rise in the current-carrying parts because of the skin effect.

One of the most common high-frequency applications is at 400 Hz. Figure 4 indicates the thermal derating multiplier to be used with each circuit breaker family when applied on 400 Hz systems.

When applying a 100 A QOU circuit breaker on a 400 Hz system, the circuit breaker’s current carrying capacity is as follows:

- Non-continuous Loads (less than three hours): Using Figure 4, the QOU circuit breaker may be applied at .78 of rating, or 78 A.
- Continuous Loads (three hours of more): NEC Article 210-20(a) requires that standard circuit breaker loading does not exceed 80% of the circuit breaker’s rating when used for continuous loads. Therefore, the current-carrying capacity of a 100 A QOU circuit breaker operating under continuous load at 400 Hz would be $100 \text{ A} \times .78 \times .80 = 62 \text{ A}$.

Figure 4: Frequency Derating of QOU Circuit Breaker at 400 Hz

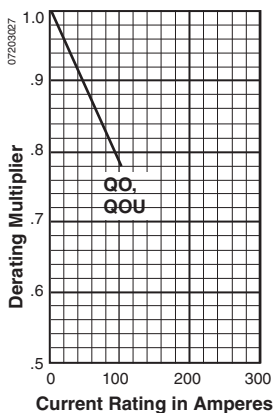

QOU Miniature Circuit Breakers and Switches Application Information

Interrupting Rating (AIR) at 400 Hz.

At frequencies above 60 Hz, the interrupting rating of thermal-magnetic circuit breakers is less than the 60 Hz interrupting rating. Unless specifically marked for use of 400 Hz systems, the interrupting rating of Square D circuit breakers is reduced to 1/10th of the 60 Hz interrupting rating.

Magnetic Tripping Performance

At frequencies above 60 Hz more current is necessary to magnetically trip a circuit breaker than at 60 Hz. Fig. 3 shows the multipliers of 60 Hz current that it takes to instantaneously trip a circuit breaker when applied at various frequencies. For example, at 60 Hz, it takes 700 A or more to magnetically trip a 100 A QOU circuit breaker per trip curve 730-7 (page 26). At 400 Hz, it takes 1820 A (2.6 multiplier) or more to magnetically trip the same circuit breaker.

Figure 5: 60 Hz Current Multiplier

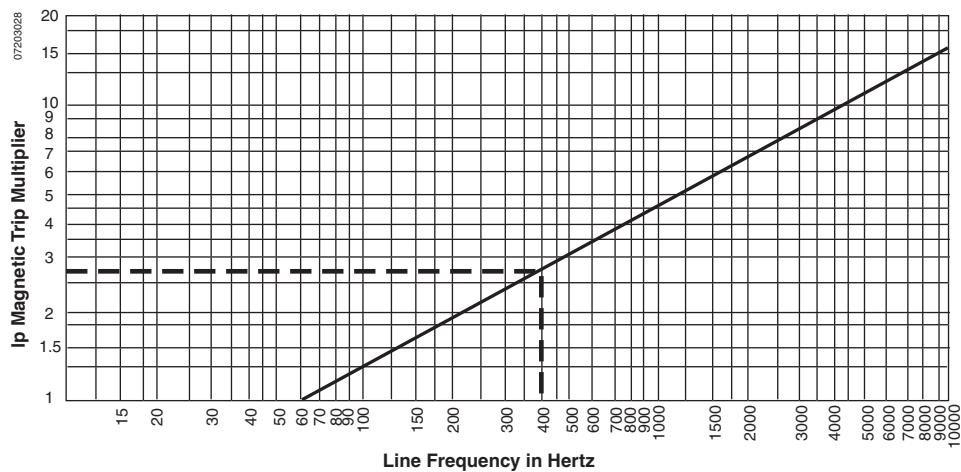

QOU Miniature Circuit Breakers and Switches Accessories

ACCESSORIES

Factory-installed Accessories

QOU circuit breakers and QYU supplementary protectors can be supplied with electrical accessories factory-installed. Available factory-installed accessories are shown in Table 5 below. Each QOU circuit breaker or QYU supplementary protector can be equipped with only one (1) factory-installed electrical accessory from the table below. These devices cannot be added, modified or removed once assembled. All electrical accessories occupy one additional pole space, 3/4 in. (19.05 mm). The proper suffix number must be added to the circuit breaker catalog number to order an accessory.

Table 5: Factory-installed Accessories

Accessory	Description	Volts, 50/60 Hz	Coil Burden, VA	Catalog Suffix
Shunt Trip	Used for tripping the circuit breaker electrically using a remote control source. Includes coil clearing contact.	12 ac/dc	60	1042
		24 ac/dc	168	
		120 Vac	72	1021
		208 Vac	228	
240 Vac	288			
Auxiliary Switch "A" Contact	One contact only; opens when circuit breaker is OFF or tripped; 5 A max. at 120 Vac, 50/60 Hz			1200
Auxiliary Switch "B" Contact	One contact only; closed when circuit breaker is OFF or tripped; 5 A max. at 120 Vac, 50/60 Hz			1201
Alarm Switch	One contact only; closed when circuit breaker is tripped; open when circuit breaker is ON or OFF; 5 A max. at 120 Vac, 50/60 Hz			2100
Ring-tongue Terminal	Factory-installed ring tongue terminal, 10-32 screw, for 1-, 2-, and 3-pole QOU 10-60 A			5283
Wire Binding Screw	Hex drive 5/32 in. wire binding screw for QOU			5280
Mounting Foot	Tapped mounting foot for QOU, 1- and 2-pole 10-70 A, 3-pole 10-60 A			3100

Figure 6: Shunt Trip Accessory

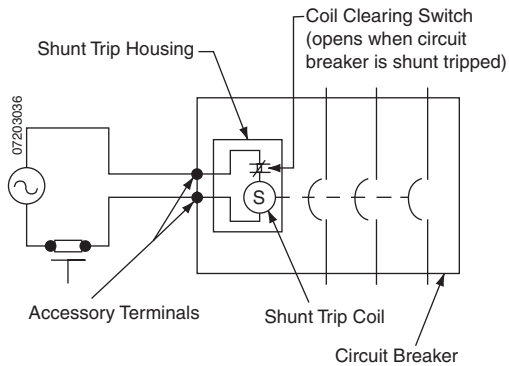

Shunt Trip

The shunt trip accessory is used to trip the circuit breaker from a remote location by using a trip coil energized from a separate electrical source. When energized by a push button or other pilot device, the shunt trip causes the circuit breaker to trip. The handle moves to the tripped position and the Visi-Trip indicator appears. The trip coil has a coil clearing contact to break the coil circuit when the circuit breaker trips. Shunt trips operate at 75% or more of rated voltage. See the wiring diagram in Figure 6.

Figure 7: Auxiliary Switch Accessory

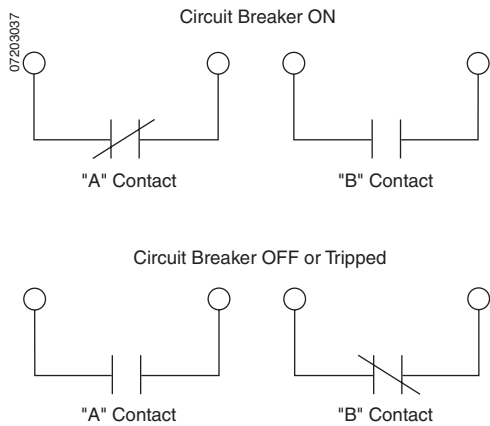

Auxiliary Switch

The auxiliary switch accessory monitors the circuit breaker contact status and provides a remote signal indicating whether the circuit breaker contacts are open or closed. When the circuit breaker is OFF or tripped, the auxiliary switch with an "A" contact is open and the auxiliary switch with a "B" contact is closed. When the circuit breaker is on, the auxiliary switch with an "A" contact is closed and the auxiliary switch with a "B" contact is open. See the wiring diagram in Figure 7.

Figure 8: Alarm Switch Accessory

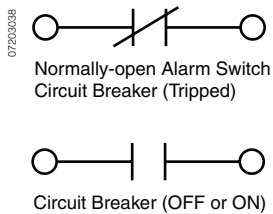

Alarm Switch

The alarm switch accessory monitors the circuit breaker trip status and is used to provide a remote warning signal indicating that the circuit breaker has tripped. This signal can be a horn, pilot light, or some other indicator. The contact on the standard alarm switch is open when the circuit breaker is in the off or on position and is closed when the circuit breaker is in the tripped position.

Alarm switches are actuated when the circuit breaker has tripped as a result of an overload, short circuit or shunt trip operation. See the wiring diagram in Figure 8.

QOU Miniature Circuit Breakers and Switches Accessories

Field-installed Accessories

Table 6: Field-installed Accessories

Accessory	Description	Catalog Number
Handle Tie	Ties two 1-pole circuit breakers together.	QO1HT
	Ties three 1-pole circuit breakers together; includes lock-off for California Title 24.	QO3HT
Handle Lock-off (Clamp)	Clamp for holding QOU single-pole handle in ON or OFF position.	QO1LO
	Attaches to 1-, 2-, or 3-pole circuit breaker handles.	HLO1
Handle Padlock Attachment	For padlocking 1-pole circuit breaker in "OFF" or "ON" position. Attaches to circuit breaker escutcheon—Fixed	QOU1PA
	For padlocking 2- and 3-pole circuit breaker in "OFF" or "ON" position. Attaches to circuit breaker escutcheon—Fixed	QOU1PL
	For padlocking 1-pole circuit breaker in "OFF" position only	QOU1PAFLA
	For padlocking 2- and 3-pole circuit breaker in "OFF" position only (1- and 2-pole 10–70 A, 3-pole 10–60 A)	QOU2PAFLA
	One-pole circuit breakers. Attaches to circuit breaker handle—Removable	QOHPL
	Two- and 3-pole circuit breakers. Attaches to circuit breaker handle—Removable	QO1HPL
Mechanical Interlock	Interlocks two 2-pole or one 2-pole and one 1-pole QOU circuit breakers	QO2DTILA
Mechanical Interlock with Retaining Kit	For interlocking two adjacent back-fed circuit breakers in dual power supply applications. Interlocks two 2-pole or one 2-pole and one 1-pole QOU circuit breakers.	QO2DTIM
Mounting Feet	For mounting 1-, 2-, or 3-pole circuit breakers (Two mounting feet required per circuit breaker)	QOUMF1
		QOUMF2
		QOUMF3
	Tapped mounting foot for QOU, 1- and 2-pole 10–70 A, 3-pole 10–60 A (Two mounting feet required per pole)	QOUMFS1
Quick Connectors	For forward or reverse wiring of 60 A maximum circuit breakers	QOUFR
	For end connection wiring of 60 A maximum circuit breakers	QOUEC
Finger Safe Cover	For 10–70 A 1- and 2-pole 10–60 A 3-pole circuit breakers (Two covers required per pole)	QOULFSC1
	For 80–100 A 1-, 2-, and 3-pole circuit breakers (Two covers required per pole)	QOUHFSC1
Jumper Bars for 2-pole Low Ampere QOUs	4-pole jumper bar with front wiring, base, cover, and screw	QOU14100JBAF
	4-pole jumper bar with wiring, base, cover, and screw to left	QOU14100JBAL
	4-pole jumper bar with wiring, base, cover, and screw to right	QOU14100JBAR
	4-pole, 100 A jumper bar base with front wiring	QOU14100BAFB
	4-pole, 100 A jumper bar base with left-side wiring	QOU14100BALB
	4-pole, 100 A jumper bar base with right-side wiring	QOU14100BARB
	4-pole jumper bar cover	QOU14100CAB
	Mounting screw for jumper bar cover	QOUQCMSB
	6-pole jumper bar with front wiring, base, cover, and screw	QOU16150JBAF
	6-pole, 150 A jumper bar base with front wiring	QOU16150BAFB
	6-pole, 150 A jumper bar base with left-side wiring	QOU16150BALB
	6-pole, 150 A jumper bar base with right-side wiring	QOU16150BARB
	6-pole jumper bar cover	QOU16150CAB
	Cover Plates	For one 2-pole circuit breaker
For one 3-pole circuit breaker		QOUCP3
For two 2-pole circuit breakers		QOUCP4
For three 2-pole circuit breakers		QOUCP6
Rainproof Cover	Vertical cover for 2- and 3-pole circuit breakers	BCV
	Horizontal cover for 2-pole circuit breakers	BCH
Ring Tongue Terminal Adapter	For ring tongue terminal wiring of 60 A maximum circuit breakers	QOURT

QOU Miniature Circuit Breakers and Switches Accessories

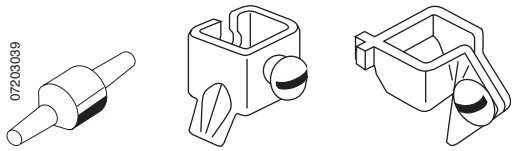

07203039
QO1HT
 Handle Tie
QO1LO
 Handle Lock-off
HLO-1
 Handle Lock-off

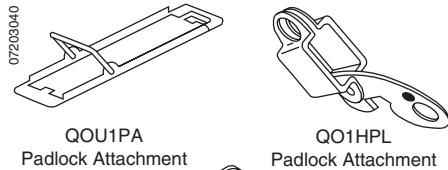

07208040
QOU1PA
 Padlock Attachment
QO1HPL
 Padlock Attachment
QOU1PL
 Padlock Attachment

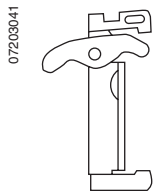

07209041
QOU2DTILA
 Mechanical Interlock Attachment

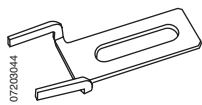

07208044
QOUMF1
 Mounting Foot



suffix -3100 or QOUMFSI
 Tapped Mounting Foot

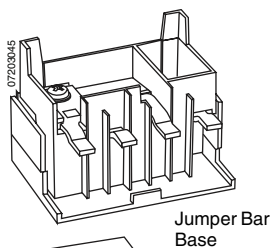

07203045
Jumper Bar Base

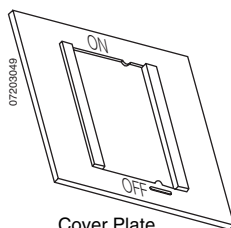

07203049
Cover Plate

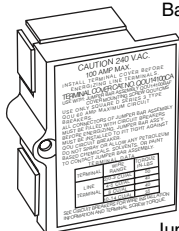

Jumper Bar Cover

Handle Tie

The handle tie accessory converts any adjacent 1-pole QOU circuit breaker to one independent-trip multi-pole circuit breaker.

Handle Lock-off

The handle lock-off accessories fasten the handle in the on or off position. The mechanism will still be able to trip and open the contacts even if the handle is held on. The handle lock-off cannot be padlocked.

Handle Padlock Attachment

The handle padlock attachments allow padlocking the circuit breaker handles in the on or off position. The mechanism will still be able to trip and open the contacts even if the handle is held on.

Mechanical Interlock Attachment

The mechanical interlock attachment locks the handles of two adjacent circuit breakers to prevent both circuit breakers from being on at the same time. Both circuit breakers may be switched to the off position with the mechanical interlock in place. The mechanism will still be able to trip and open the contacts even if the handle is held on.

Mounting Feet

Mounting feet are available to mount 1-, 2-, and 3-pole circuit breakers. Two brackets (two kits) are required to mount each circuit breaker.

Tapped Mounting Feet

Tapped versions of the mounting feet are available to mount 1-, 2-, and 3-pole circuit breakers. Two brackets (one kit) are required to mount each circuit breaker.

Jumper Bars

For added wiring convenience, jumper bars are available for common connections to two 2-pole or three 2-pole 60 A maximum QOU circuit breakers. Jumper bars are available with front, left-side, or right-side wiring bases and covers.

Cover Plates

Cover plates are available to fit one 2-pole, one 3-pole, two 2-pole, or three 2-pole circuit breakers. The cover plates fasten to the escutcheon and provide 1 in. (25.4 mm) per pole finish trim to cover the circuit breaker.

QOU Miniature Circuit Breakers and Switches Accessories

Finger Safe Covers

Finger safe covers are installed over the top of the terminal connections to prevent accidental contact with energized parts. Two covers are required per pole of each circuit breaker.

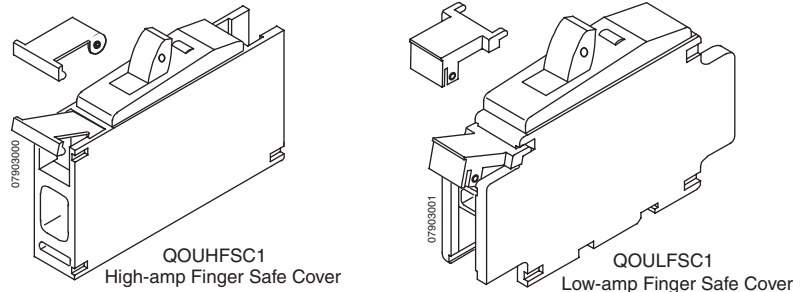

Rainproof Covers

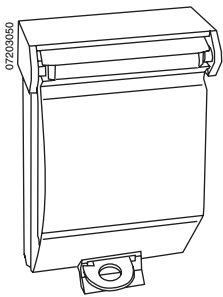

Ring-tongue Terminal Adapter

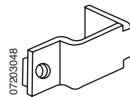

Rainproof Covers

Rainproof covers plates are available for vertical mounted 2- and 3-pole circuit breakers and horizontal mounted 2-pole circuit breakers.

Ring-tongue Terminal Adapters

Ring-tongue terminal adapters are available for ring tongue terminal wiring of 60 A maximum circuit breakers.

Reversible Lugs

For added wiring convenience, QOUR 10–70 A 1- and 2-pole, and 10–60 A 3-pole QOUR circuit breakers have reversible lugs. Removing the wire binding screw allows the captive lug body to be rotated and the wire binding screw reinstalled. This permits the circuit breaker to be flush mounted and then conveniently wired from the back.

Forward or Reverse Quick Connector

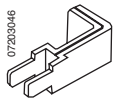

End Quick Connector

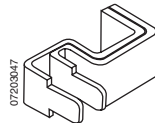

Quick Connectors

In addition to the reversible lugs previously described, 10–70 A 1- and 2-pole, and 10–60 A 3-pole A QOU circuit breakers have optional field installable quick connectors.

Quick connectors provide a convenient way to attach two wires using two standard, 0.25 in. insulated quick connectors per terminal (30 A maximum per connector). Quick connectors are not furnished with the circuit breakers, but are commercially available. Connectors suitable for wire sizes up to AWG #10 can be selected for use with these circuit breakers.

Table 7: Optional Terminations

Type	Wiring Method	Quantity	Catalog Number
Field-installed Quick Connectors	Forward or Reverse	1	QOUFR
Field-installed Quick Connectors	End Connection	1	QOUEC
Factory-installed Quick Connectors	One each end of QOU for end connection	—	QOUQ prefix

Available only on 10–60 ampere circuit breakers.

QOU Miniature Circuit Breakers and Switches UL Requirements

UL REQUIREMENTS

A UL label on the QOU miniature circuit breaker indicates that the circuit breaker meets the requirements of UL Standard 489 for molded case circuit breakers.

Underwriters Laboratories Inc. (UL), the Canadian Standards Association (CSA), the National Electrical Manufacturers Association (NEMA), and the National Electrical Code (NEC) all define a circuit breaker as “a device designed to open and close a circuit by non-automatic means and to open the circuit automatically at a predetermined overcurrent without damage to itself when properly applied within its rating.”

A molded case circuit breaker is one “that is assembled as an integral unit in a supportive and enclosing housing of insulated material.”

A UL label also means the production procedure is monitored by UL inspectors for continuing conformance to UL performance requirements. These requirements are based on sound engineering principles, research, records of test and field experience, and information gathered from users and inspection authorities.

UL 489 and CSA 22.2 #5-02 Test Procedures

Limited Available Fault Current Tests

UL and CSA require a series of tests on a single set of sample circuit breakers for compliance with UL Standard 489. The tests for thermal-magnetic circuit breakers are described below and conducted in the order presented.

Since QOU switches are derivatives of QOU miniature circuit breakers, they do not have to go through an overload test. They have to complete a withstand test (paragraph 11.1.7).

200% Thermal Calibration

Each pole of the circuit breaker must trip within a specified time limit when carrying 200% of its ampere rating.

135% Thermal Calibration

With all poles connected in series, the circuit breaker must trip within a specified time limit when carrying 135% of its ampere rating.

Overload

The circuit breaker is operated making and breaking 600% of its ampere rating, but not less than 150 A. For circuit breakers through 100 A, the number of 600% operations is 35 manual open and close and 15 manual close and automatic open. For 125 A circuit breakers, the number of operations is 50 manual open and close.

Temperature Rise

While carrying 100% of rated current at a 104° F (40° C) ambient temperature and mounted in open air, the circuit breaker is checked for temperature rise on a wiring terminal. The temperature rise must not exceed a 122° F (50° C) rise above ambient temperature and must be within specified limits.

Endurance

The circuit breaker must successfully complete the number of switching operations shown in the table below. One switching operation includes a motion to turn the circuit breaker on and a motion to turn the circuit breaker off.

Table 8: QOU Circuit Breaker Switching Operations

Amperes	Full Load Operations	No Load Operations
0–100 A	6000	4000
125 A	4000	4000

QOU Miniature Circuit Breakers and Switches UL Requirements

Calibration Retest

Both the 200% and 135% thermal calibration tests are repeated.

Short Circuit

For circuit breakers rated 240 V, two short-circuit tests per pole and one test with all poles connected in series are performed. For example, a three-pole circuit breaker receives seven short-circuit tests. For circuit breakers rated 120/240 V, three tests are made with all poles connected in series. The circuit breaker is connected to the test circuit using wire correctly sized for the rating of the circuit breaker. The line leads are not more than 4 ft. (1.22 m) in length and the load leads are not more than 10 in. (25.4 cm) in length.

NOTE: Successful testing requires that the current be interrupted while maintaining the integrity of all conductors and connections.

Trip Out

The 200% thermal calibration test is repeated following the short-circuit tests.

Dielectric

The circuit breaker must withstand, for one minute, twice its rated voltage plus 1000 V:

- Between line and load terminals with the circuit breaker open, that is, with the circuit breaker either tripped or off.
- Between terminals of opposite polarity with the circuit breaker open.
- Between live parts and the overall enclosure with the circuit breaker both open and closed.

No conditioning of the circuit breaker can take place during or between tests. There also can be no failure of functional parts at the conclusion of the sequences.

High Available Fault Current Tests

After qualifying a set of circuit breakers to the standard tests, a manufacturer can have additional circuit breaker samples tested on higher than standard available fault currents.

The following performance requirements apply:

200% Thermal Calibration

Each pole of the circuit breaker must trip within a specified time limit when carrying 200% of its continuous current rating.

Short Circuit

With the load side terminals connected by 10 in. (25.4 cm) lengths of specified wire, the circuit breaker is exposed to a short-circuit current. After successful interruption, the circuit breaker is reset and closed again on the short circuit. An additional short-circuit bus-connected test is required for frame sizes or construction groups below 100 A.

Trip Out

Each pole of the circuit breaker must trip within a specified time limit when carrying 250% of its continuous current rating.

Dielectric Withstand

The circuit breaker is subjected to twice its rated voltage, but not less than 900 V.

QOU Miniature Circuit Breakers and Switches

Circuit Breaker Tripping Characteristics (Trip Curves)

CIRCUIT BREAKER TRIPPING CHARACTERISTICS (TRIP CURVES)

The tripping characteristics of thermal-magnetic circuit breakers are represented by a characteristic tripping curve that plots tripping time versus current level. See page 20. The curve shows the amount of time required for a circuit breaker to trip for overcurrent through the entire tripping range of the circuit breaker. Manufacturing tolerances result in a curve that is a band bound by minimum and maximum values of total clearing time. Total clearing time is the sum of the sensing time, unlatching time, mechanical operating time, and arcing time of the circuit breaker. For currents in excess of 135 percent of the circuit breaker rating at ambient temperature (40°C/104°F), the circuit breaker will automatically open the circuit within limits specified by the band.

Thermal Tripping Characteristics

The upper left portion of the characteristic tripping curve displays the thermal response of the circuit breaker. On overcurrent levels, up to the instantaneous tripping level, thermal tripping occurs when the bimetal in the circuit breaker responds to the heat associated with the overcurrent. The bimetal deflects, unlatching the mechanism and mechanically causing the circuit breaker to trip and open the circuit. The larger the overcurrent, the faster the circuit breaker operates to open the circuit (inverse time).

Magnetic (Instantaneous) Tripping Characteristics

The lower right portion of the characteristic tripping curve displays the magnetic (instantaneous) tripping response of the circuit breaker. This takes place when overcurrents of sufficient magnitude operate the magnetic tripping mechanism. Magnetic tripping occurs with no intentional delay.

QOU Miniature Circuit Breakers and Switches Tripping Curves

TRIPPING CURVES

Curve 730-1

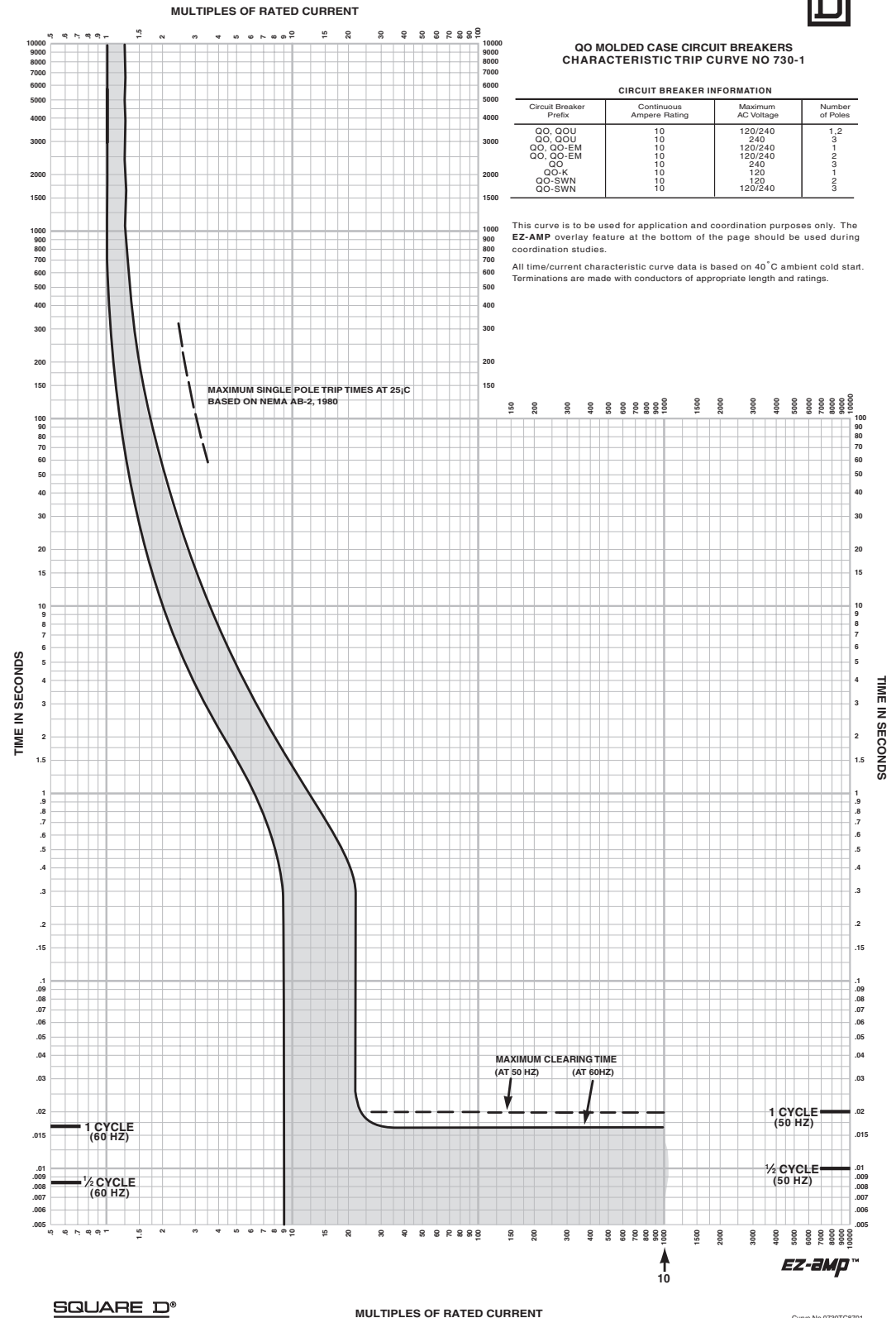

SQUARE D
Copyright © Square D Company 1987

MULTIPLES OF RATED CURRENT

Curve No. 0730TC8701
Drawing No. B48095-730-01

QOU Miniature Circuit Breakers and Switches Tripping Curves

Curve 730-2

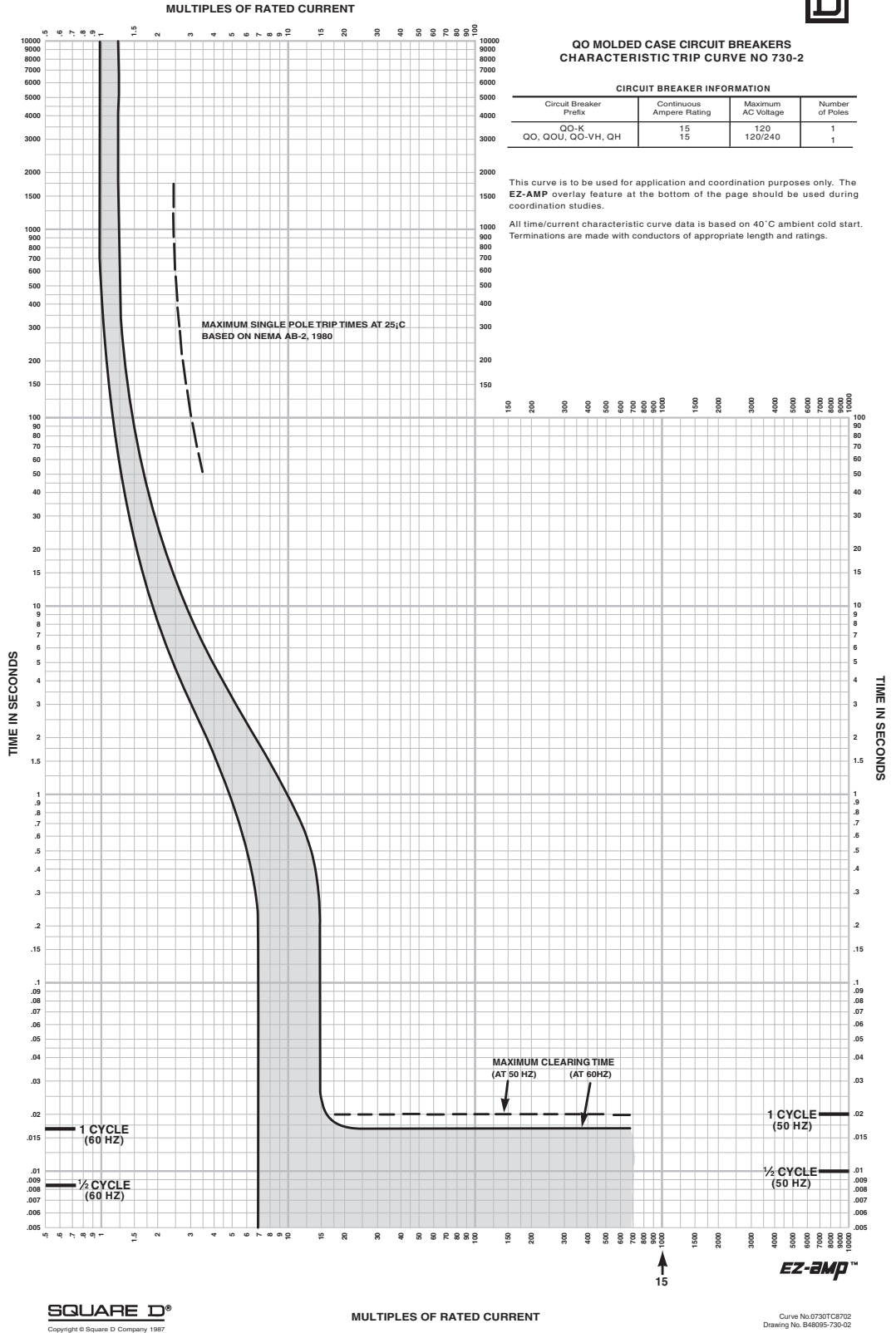

QOU Miniature Circuit Breakers and Switches Tripping Curves

Curve 730-3

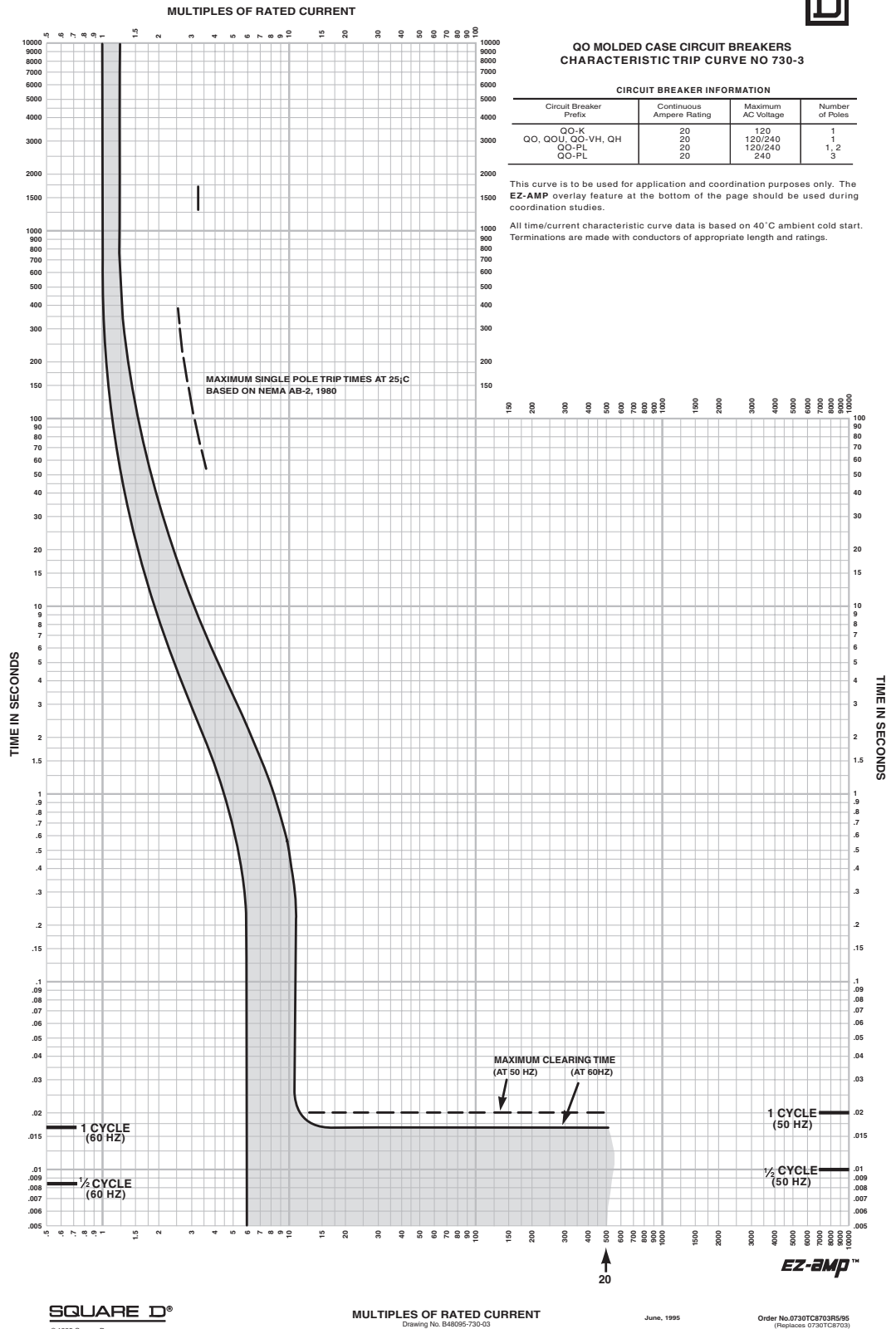

QOU Miniature Circuit Breakers and Switches Tripping Curves

Curve 730-4

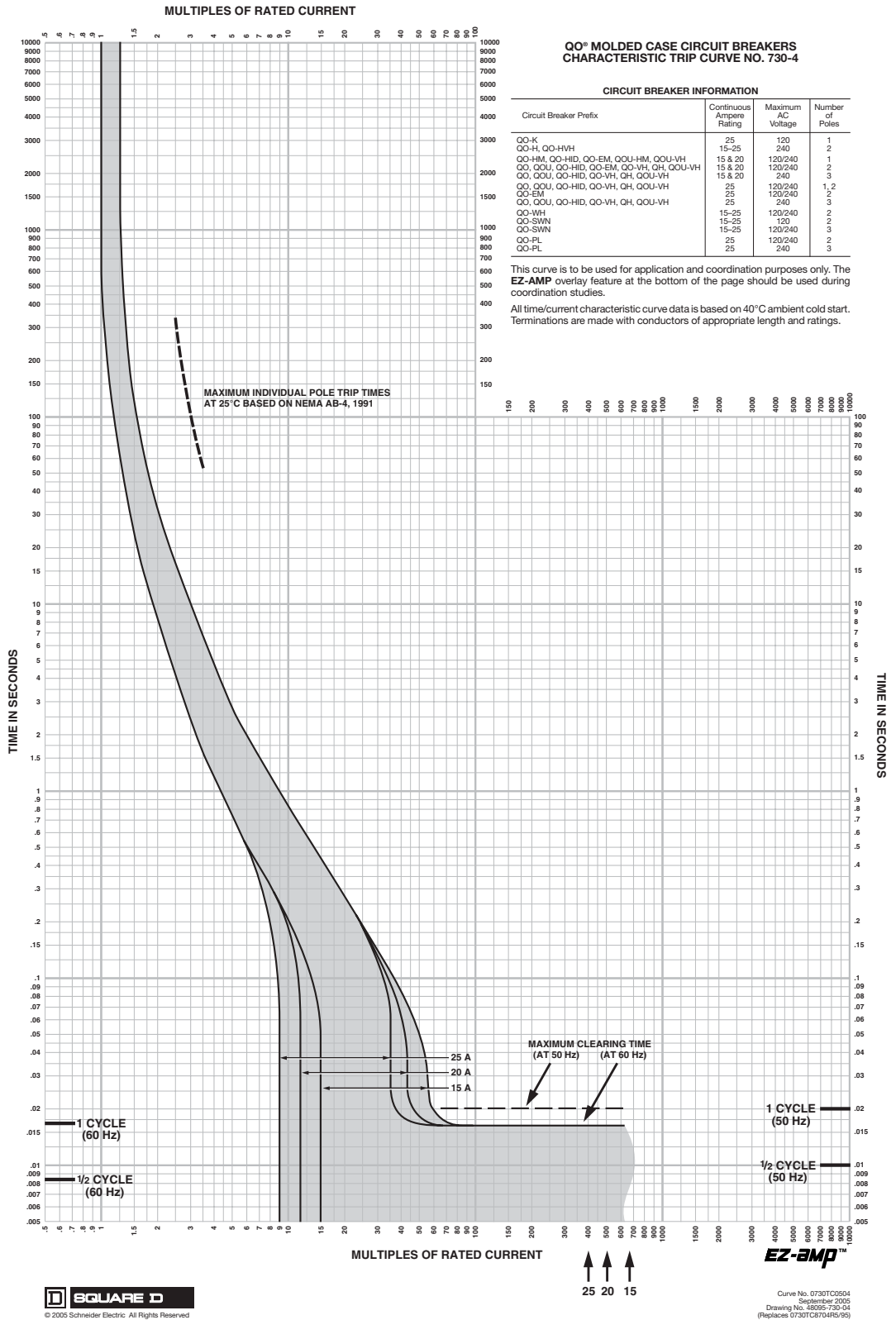

QOU Miniature Circuit Breakers and Switches Tripping Curves

Curve 730-5

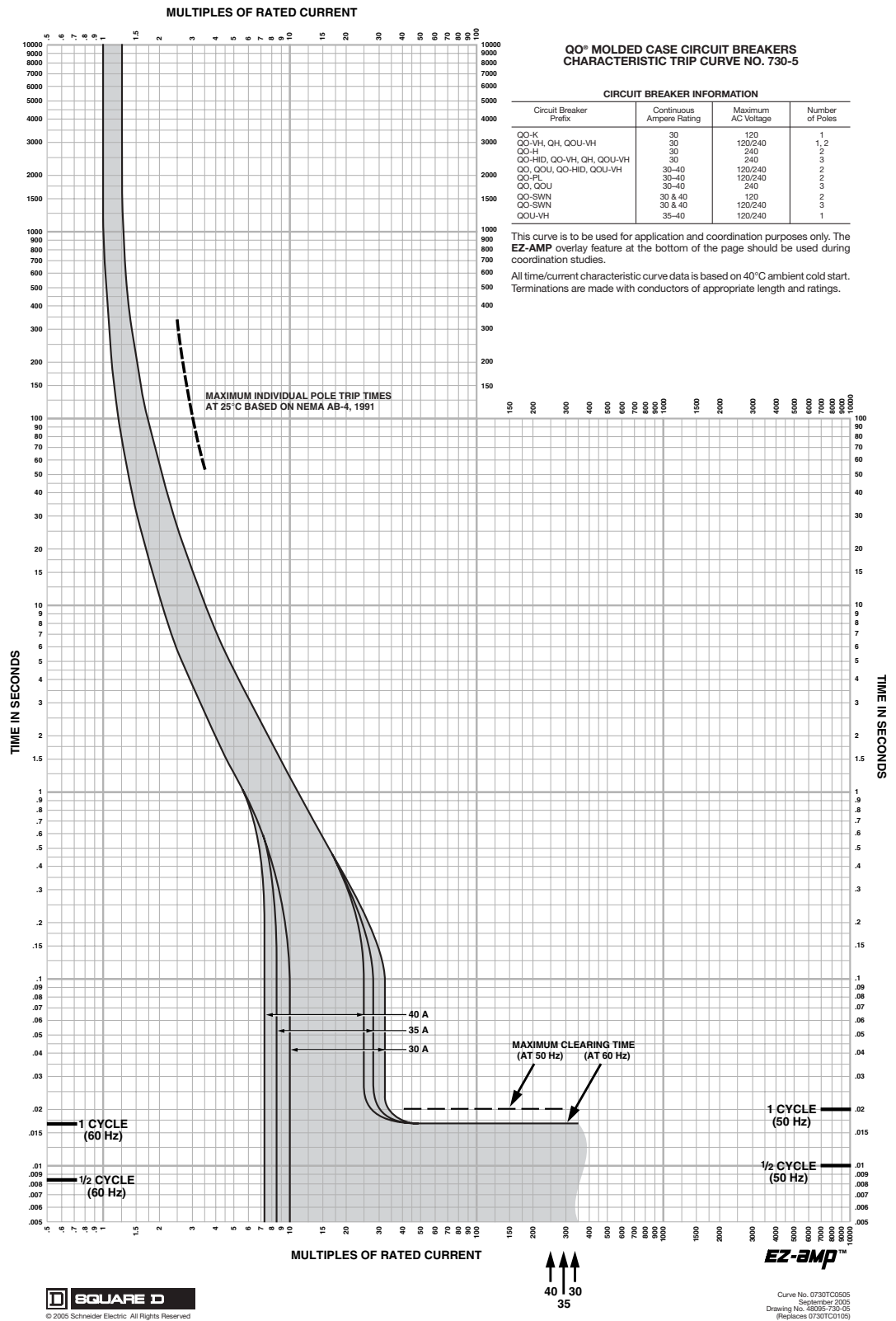

QOU Miniature Circuit Breakers and Switches Tripping Curves

Curve 730-6

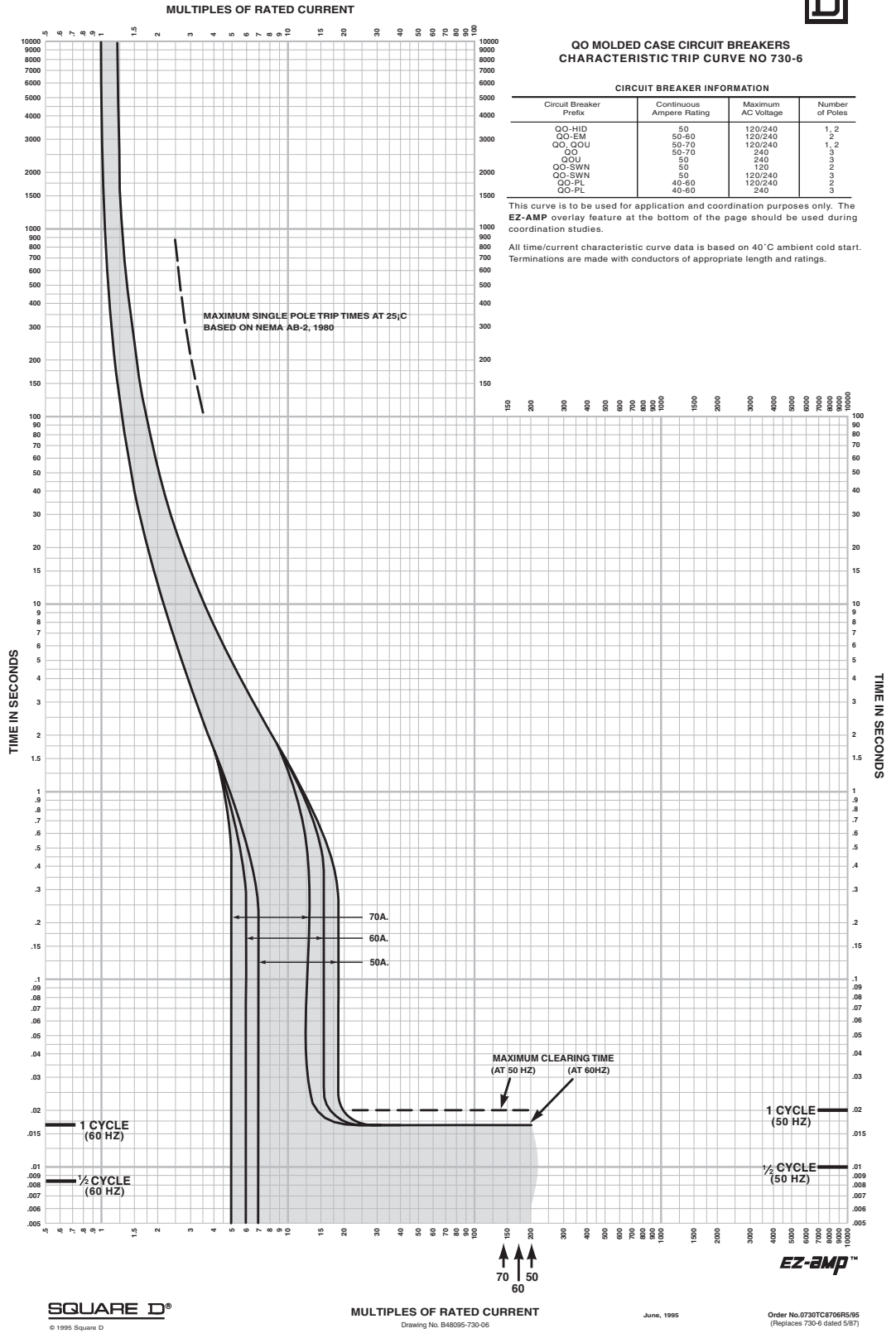

QOU Miniature Circuit Breakers and Switches Tripping Curves

Curve 730-7

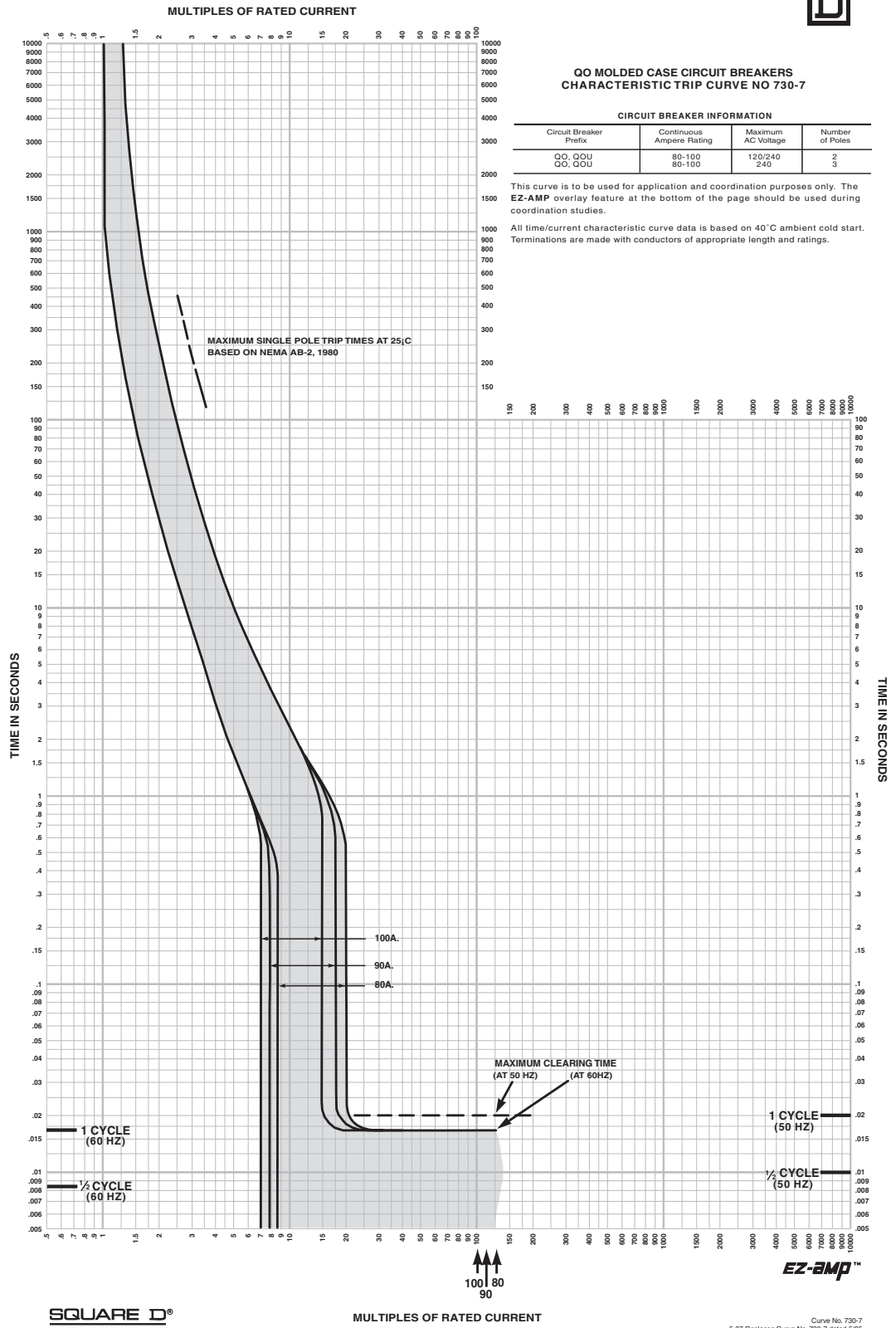

QOU Miniature Circuit Breakers and Switches Tripping Curves

Curve 730-9

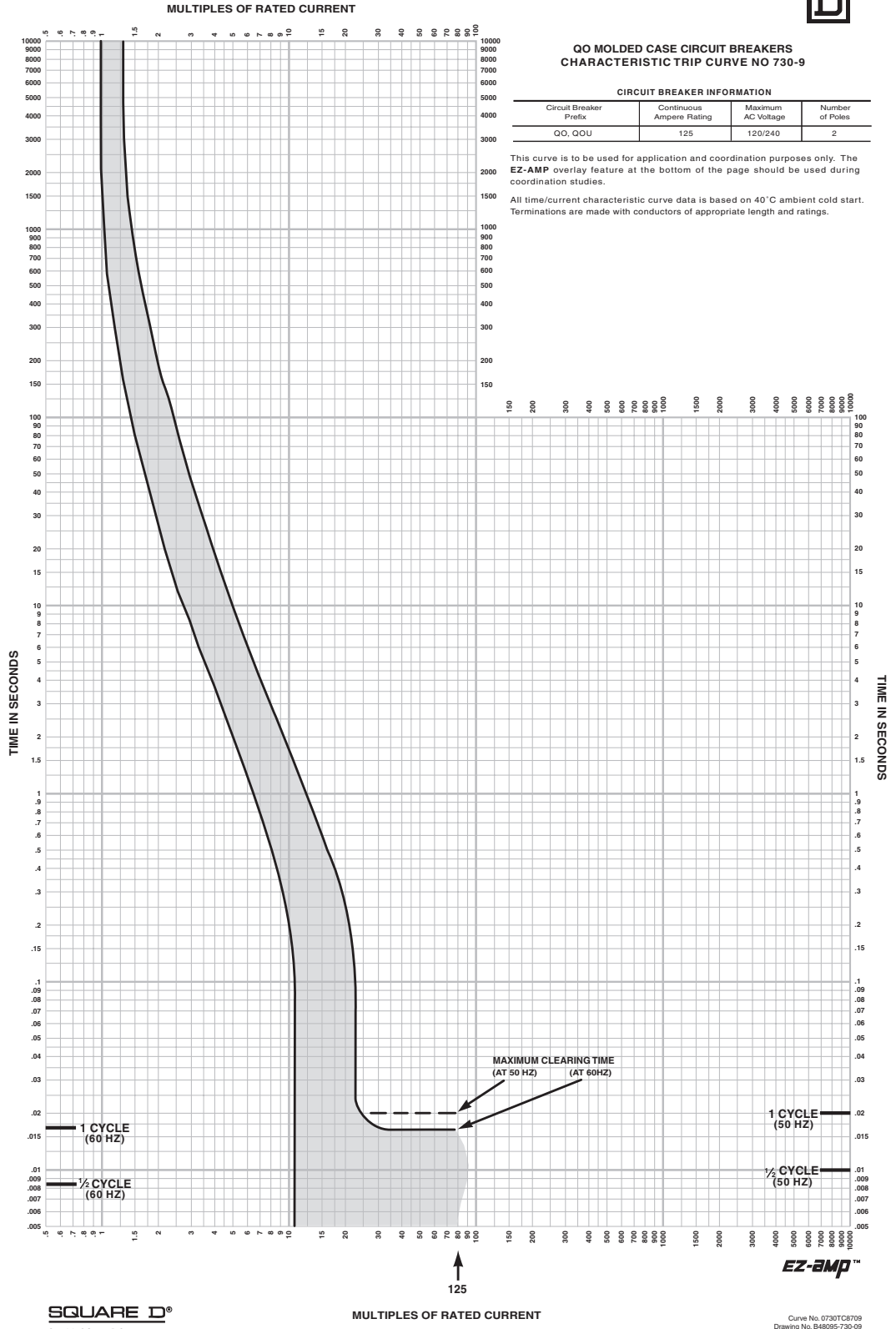

QOU Miniature Circuit Breakers and Switches Dimensions

DIMENSIONS

1 & 2 pole 10A - 70A and 3 pole 10A -60A QOU Circuit Breakers

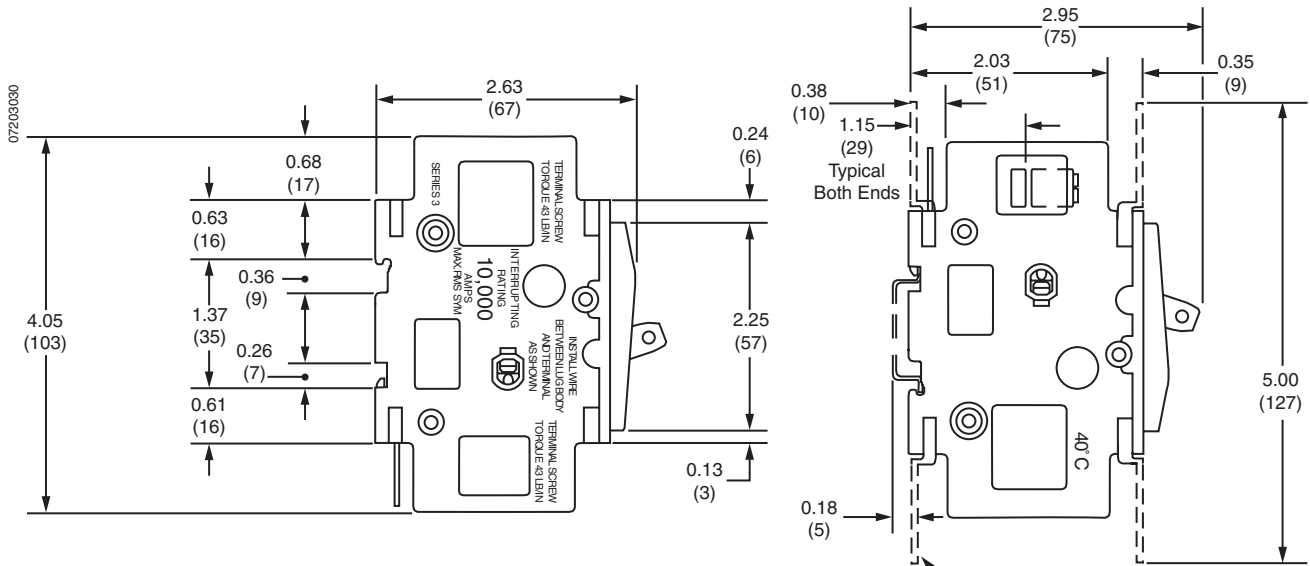

Mounting Brackets to be installed on both ends as shown.
Catalog Numbers:
One-Pole—QOUMF1
Two-Pole—QOUMF2
Three-Pole—QOUMF3

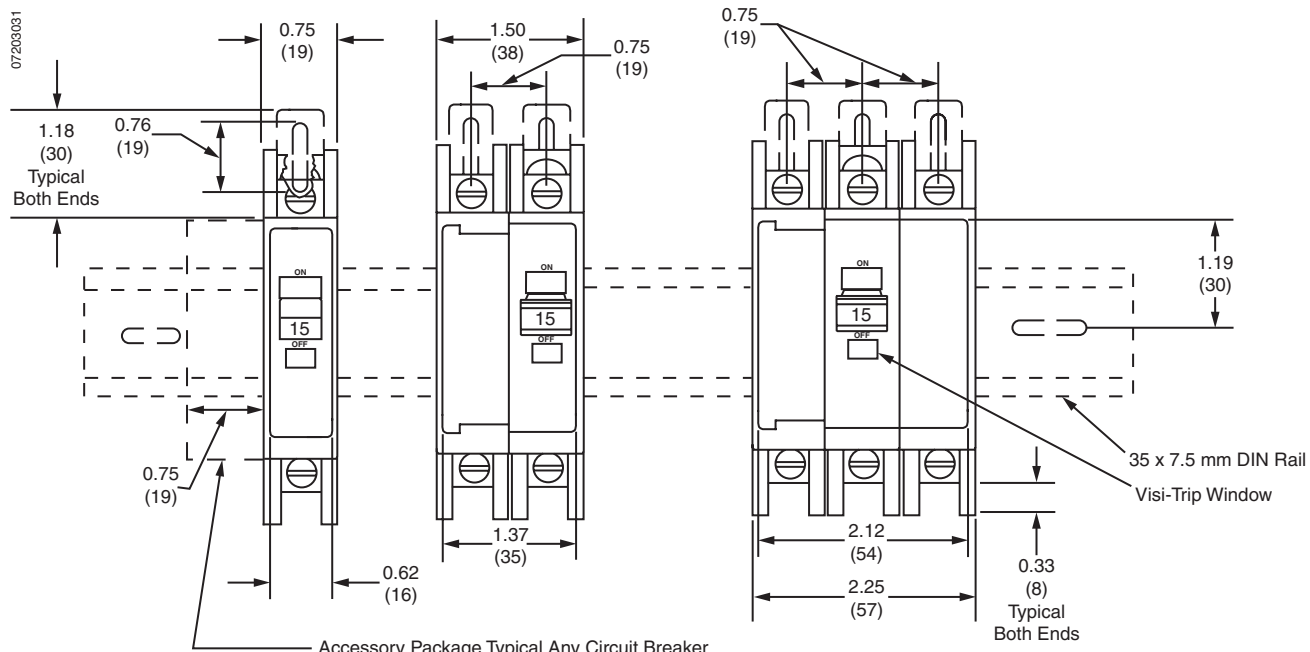

Accessory Package Typical Any Circuit Breaker
(Shunt Trip, "A" or "B" Switch, Bell Alarm)

Dim. : in. / pulg / po mm

QOU Miniature Circuit Breakers and Switches Dimensions

80A - 125A Circuit Breakers

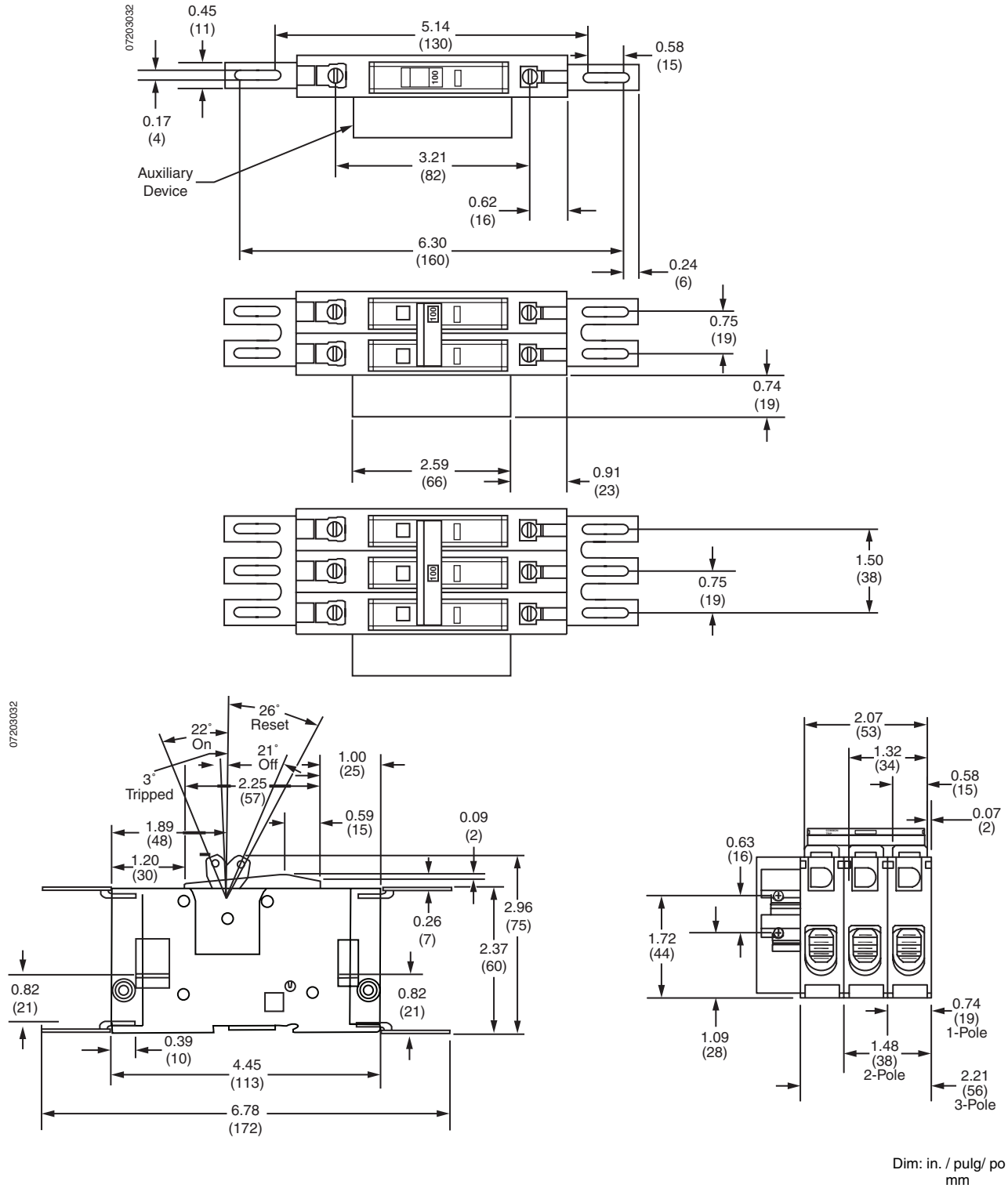

QOU Miniature Circuit Breakers and Switches

QYU One-Pole 277 Vac Supplementary Protectors

QYU ONE-POLE 277 VAC SUPPLEMENTARY PROTECTORS

Description

QYU 277 Vac supplementary protectors are available for surface, flush or DIN-rail mounting in 1-pole construction. Supplementary protectors are 3/4 in. (19.05 mm) wide.

Table 9: Selection Data

UL Component Recognized Interrupting 5000 RMS Symmetrical Amperes		
1-Pole—277 Vac		
Ampere Rating	Catalog Number	Terminal Lug Wire Size (AWG)
10	QYU110	1—#14–2 Cu or Al
20	QYU120	
25	QYU125	
30	QYU130	

Applications

One-pole QYU 277 Vac supplementary protectors are UL Recognized Component (meets UL 1077) to be applied on systems where the maximum phase-to-ground voltage is 277 Vac or less, including use of 240 Vac corner grounded delta “grounded B” systems.

These devices are designed to provide supplemental overcurrent protection in accordance with Article 240-10 of the 2005 NEC, which states that thermal-magnetic supplementary protectors cannot be used to replace the primary branch-circuit protection in an application. When used in combination with branch-circuit protection, as required in Article 210 of the 2005 NEC, these supplementary protectors can be used to protect lighting fixtures, appliances and other equipment or internal circuits and components of equipment.

Tripping Characteristics

The QYU trip characteristics are identical to those of the same amperage QOU circuit breaker. See trip curves 730-1, -3, -4 and -5.

QOU Miniature Circuit Breakers and Switches Dimensions

DIMENSIONS

QYU One-pole 277 Vac Supplementary Protectors

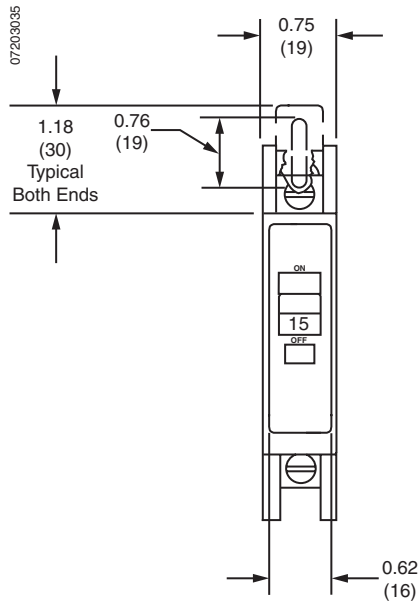
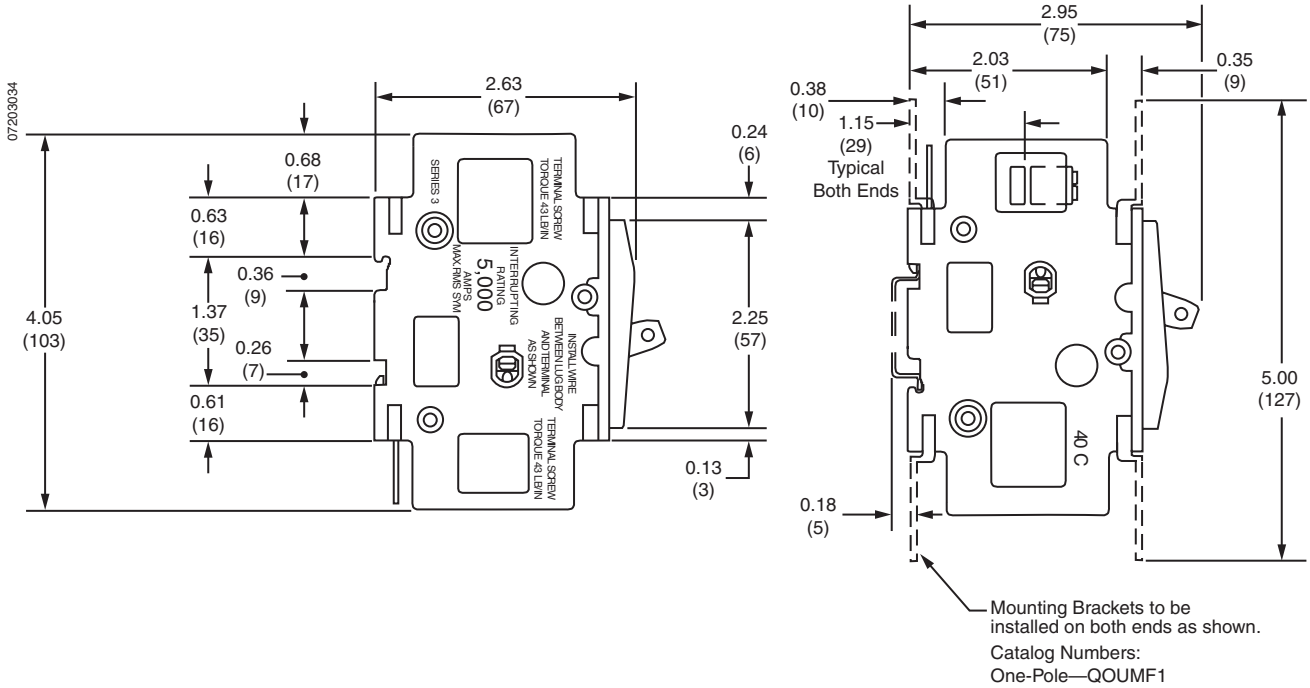

Schneider Electric USA

3700 Sixth St. SW
Cedar Rapids, IA 52404
USA
1-888-Square D
1-888-778-2733

0720CT9401R1/05 © 2005 Schneider Electric All Rights Reserved
Replaces 0720CT9401 dated 08/1994

09/2005