

LM117/LM317A/LM317

3-Terminal Adjustable Regulator

General Description

The LM117 series of adjustable 3-terminal positive voltage regulators is capable of supplying in excess of 1.5A over a 1.2V to 37V output range. They are exceptionally easy to use and require only two external resistors to set the output voltage. Further, both line and load regulation are better than standard fixed regulators. Also, the LM117 is packaged in standard transistor packages which are easily mounted and handled.

In addition to higher performance than fixed regulators, the LM117 series offers full overload protection available only in IC's. Included on the chip are current limit, thermal overload protection and safe area protection. All overload protection circuitry remains fully functional even if the adjustment terminal is disconnected.

Normally, no capacitors are needed unless the device is situated more than 6 inches from the input filter capacitors in which case an input bypass is needed. An optional output capacitor can be added to improve transient response. The adjustment terminal can be bypassed to achieve very high ripple rejection ratios which are difficult to achieve with standard 3-terminal regulators.

Besides replacing fixed regulators, the LM117 is useful in a wide variety of other applications. Since the regulator is "floating" and sees only the input-to-output differential voltage, supplies of several hundred volts can be regulated as long as

the maximum input to output differential is not exceeded, i.e., avoid short-circuiting the output.

Also, it makes an especially simple adjustable switching regulator, a programmable output regulator, or by connecting a fixed resistor between the adjustment pin and output, the LM117 can be used as a precision current regulator. Supplies with electronic shutdown can be achieved by clamping the adjustment terminal to ground which programs the output to 1.2V where most loads draw little current.

For applications requiring greater output current, see LM150 series (3A) and LM138 series (5A) data sheets. For the negative complement, see LM137 series data sheet.

Features

- Guaranteed 1% output voltage tolerance (LM317A)
- Guaranteed max. 0.01%/V line regulation (LM317A)
- Guaranteed max. 0.3% load regulation (LM117)
- Guaranteed 1.5A output current
- Adjustable output down to 1.2V
- Current limit constant with temperature
- P+ Product Enhancement tested
- 80 dB ripple rejection
- Output is short-circuit protected

Typical Applications

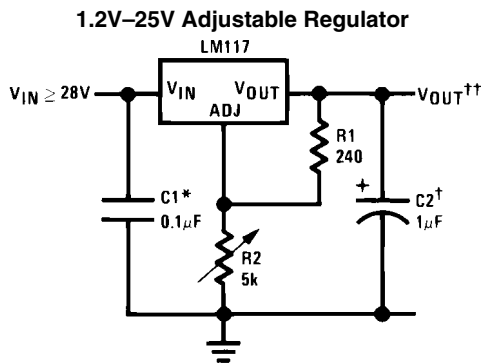

906301

Full output current not available at high input-output voltages

*Needed if device is more than 6 inches from filter capacitors.

†Optional—improves transient response. Output capacitors in the range of 1µF to 1000µF of aluminum or tantalum electrolytic are commonly used to provide improved output impedance and rejection of transients.

$$\dagger\dagger V_{OUT} = 1.25V \left(1 + \frac{R_2}{R_1} \right) + I_{ADJ}(R_2)$$

LM117/LM317A/LM317 Package Options

Part Number	Suffix	Package	Output Current
LM117, LM317	K	TO-3	1.5A
LM317A, LM317	T	TO-220	1.5A
LM317	S	TO-263	1.5A
LM317A, LM317	EMP	SOT-223	1.0A
LM117, LM317A, LM317	H	TO-39	0.5A
LM117	E	LCC	0.5A
LM317A, LM317	MDT	TO-252	0.5A

SOT-223 vs. TO-252 (D-Pak) Packages

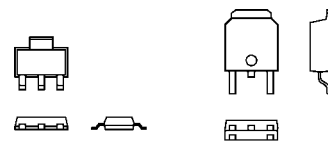

SOT-223

TO-252

906354

Scale 1:1

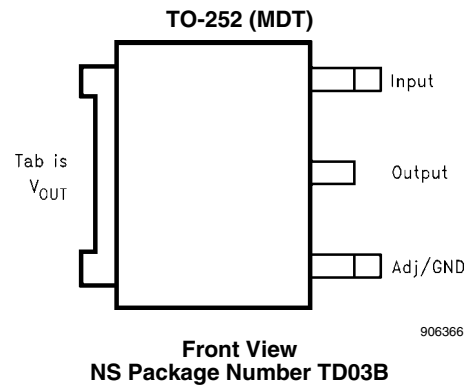
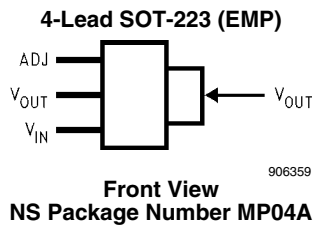

Ordering Information

Package	Temperature Range	Output Current	Order Number	Package Marking	Transport Media	NSC Drawing
TO-3 Metal Can (K)	$-55^{\circ}\text{C} \leq T_J \leq +150^{\circ}\text{C}$	1.5A	LM117K STEEL	LM117K STEEL P+	50 Per Bag	K02A
	$0^{\circ}\text{C} \leq T_J \leq +125^{\circ}\text{C}$	1.5A	LM317K STEEL	LM317K STEEL P+	50 Per Bag	
	$-55^{\circ}\text{C} \leq T_J \leq +150^{\circ}\text{C}$	1.5A	LM117K/883	LM117K/883	50 Per Bag	K02C
TO-220 3- Lead	$-40^{\circ}\text{C} \leq T_J \leq +125^{\circ}\text{C}$	1.5A	LM317AT	LM317AT P+	45 Units/Rail	T03B
	$0^{\circ}\text{C} \leq T_J \leq +125^{\circ}\text{C}$	1.5A	LM317T	LM317T P+	45 Units/Rail	
TO-263 3- Lead	$0^{\circ}\text{C} \leq T_J \leq +125^{\circ}\text{C}$	1.5A	LM317S	LM317S P+	45 Units/Rail	TS3B
			LM317SX		500 Units Tape and Reel	
SOT-223 4- Lead	$0^{\circ}\text{C} \leq T_J \leq +125^{\circ}\text{C}$	1.0A	LM317EMP	N01A	1k Units Tape and Reel	MP04A
			LM317EMPX		2k Units Tape and Reel	
	$-40^{\circ}\text{C} \leq T_J \leq +125^{\circ}\text{C}$	1.0A	LM317AEMP	N07A	1k Units Tape and Reel	
			LM317AEMPX		2k Units Tape and Reel	
TO-39 Metal Can (H)	$-55^{\circ}\text{C} \leq T_J \leq +150^{\circ}\text{C}$	0.5A	LM117H	LM117H P+	500 Per Box	H03A
	$-55^{\circ}\text{C} \leq T_J \leq +150^{\circ}\text{C}$	0.5A	LM117H/883	LM117H/883	20 Per Tray	
	$-40^{\circ}\text{C} \leq T_J \leq +125^{\circ}\text{C}$	0.5A	LM317AH	LM317AH P+	500 Per Box	
	$0^{\circ}\text{C} \leq T_J \leq +125^{\circ}\text{C}$	0.5A	LM317H	LM317H P+	500 Per Box	
LCC	$-55^{\circ}\text{C} \leq T_J \leq +150^{\circ}\text{C}$	0.5A	LM117E/883	LM117E/883	50 Units/Rail	E20A
TO-252 3- Lead D-Pack	$0^{\circ}\text{C} \leq T_J \leq +125^{\circ}\text{C}$	0.5A	LM317MDT	LM317MDT	75 Units/Rail	TD03B
			LM317MDTX		2.5k Units Tape and Reel	
	$-40^{\circ}\text{C} \leq T_J \leq +125^{\circ}\text{C}$	0.5A	LM317AMDT	LM317AMDT	75 Units/Rail	
			LM317AMDTX		2.5k Units Tape and Reel	

Absolute Maximum Ratings (Note 1)

If Military/Aerospace specified devices are required, please contact the National Semiconductor Sales Office/Distributors for availability and specifications.

Power Dissipation	Internally Limited
Input-Output Voltage Differential	+40V, -0.3V
Storage Temperature	-65°C to +150°C
Lead Temperature	
Metal Package (Soldering, 10 seconds)	300°C
Plastic Package (Soldering, 4 seconds)	260°C
ESD Tolerance (Note 5)	3 kV

Operating Temperature Range

LM117	$-55^{\circ}\text{C} \leq T_J \leq +150^{\circ}\text{C}$
LM317A	$-40^{\circ}\text{C} \leq T_J \leq +125^{\circ}\text{C}$
LM317	$0^{\circ}\text{C} \leq T_J \leq +125^{\circ}\text{C}$

Preconditioning

Thermal Limit Burn-In	All Devices 100%
-----------------------	------------------

LM117 Electrical Characteristics (Note 3)

Specifications with standard type face are for $T_J = 25^{\circ}\text{C}$, and those with **boldface type** apply over full Operating Temperature Range. Unless otherwise specified, $V_{IN} - V_{OUT} = 5\text{V}$, and $I_{OUT} = 10\text{ mA}$.

Parameter	Conditions	LM117 (Note 2)			
		Min	Typ	Max	Units
Reference Voltage	$3\text{V} \leq (V_{IN} - V_{OUT}) \leq 40\text{V}$, $10\text{ mA} \leq I_{OUT} \leq I_{MAX}$	1.20	1.25	1.30	V
Line Regulation	$3\text{V} \leq (V_{IN} - V_{OUT}) \leq 40\text{V}$ (Note 4)		0.01 0.02	0.02 0.05	%/V
Load Regulation	$10\text{ mA} \leq I_{OUT} \leq I_{MAX}$ (Note 4)		0.1 0.3	0.3 1	%
Thermal Regulation	20 ms Pulse		0.03	0.07	%/W
Adjustment Pin Current			50	100	μA
Adjustment Pin Current Change	$10\text{ mA} \leq I_{OUT} \leq I_{MAX}$ $3\text{V} \leq (V_{IN} - V_{OUT}) \leq 40\text{V}$		0.2	5	μA
Temperature Stability	$T_{MIN} \leq T_J \leq T_{MAX}$		1		%
Minimum Load Current	$(V_{IN} - V_{OUT}) = 40\text{V}$		3.5	5	mA
Current Limit	$(V_{IN} - V_{OUT}) \leq 15\text{V}$ K Package H, E Package	1.5 0.5	2.2 0.8	3.4 1.8	A
	$(V_{IN} - V_{OUT}) = 40\text{V}$ K Package H, E Package	0.3 0.15	0.4 0.20		A
RMS Output Noise, % of V_{OUT}	$10\text{ Hz} \leq f \leq 10\text{ kHz}$		0.003		%
Ripple Rejection Ratio	$V_{OUT} = 10\text{V}$, $f = 120\text{ Hz}$, $C_{ADJ} = 0\text{ }\mu\text{F}$		65		dB
	$V_{OUT} = 10\text{V}$, $f = 120\text{ Hz}$, $C_{ADJ} = 10\text{ }\mu\text{F}$	66	80		dB
Long-Term Stability	$T_J = 125^{\circ}\text{C}$, 1000 hrs		0.3	1	%
Thermal Resistance, θ_{JC} Junction-to-Case	K (TO-3) Package		2		$^{\circ}\text{C}/\text{W}$
	H (TO-39) Package		21		
	E (LCC) Package		12		
Thermal Resistance, θ_{JA} Junction-to-Ambient (No Heat Sink)	K (TO-3) Package		39		$^{\circ}\text{C}/\text{W}$
	H (TO-39) Package		186		
	E (LCC) Package		88		

LM317A and LM317 Electrical Characteristics (Note 3)

Specifications with standard type face are for $T_J = 25^\circ\text{C}$, and those with **boldface type** apply over **full Operating Temperature Range**. Unless otherwise specified, $V_{IN} - V_{OUT} = 5\text{V}$, and $I_{OUT} = 10\text{mA}$.

Parameter	Conditions	LM317A			LM317			Units
		Min	Typ	Max	Min	Typ	Max	
Reference Voltage		1.238	1.250	1.262	-	1.25	-	V
	$3\text{V} \leq (V_{IN} - V_{OUT}) \leq 40\text{V}$, $10\text{mA} \leq I_{OUT} \leq I_{MAX}$	1.225	1.250	1.270	1.20	1.25	1.30	V
Line Regulation	$3\text{V} \leq (V_{IN} - V_{OUT}) \leq 40\text{V}$ (Note 4)		0.005 0.01	0.01 0.02		0.01 0.02	0.04 0.07	%/V
Load Regulation	$10\text{mA} \leq I_{OUT} \leq I_{MAX}$ (Note 4)		0.1 0.3	0.5 1		0.1 0.3	0.5 1.5	%
Thermal Regulation	20 ms Pulse		0.04	0.07		0.04	0.07	%/W
Adjustment Pin Current			50	100		50	100	μA
Adjustment Pin Current Change	$10\text{mA} \leq I_{OUT} \leq I_{MAX}$ $3\text{V} \leq (V_{IN} - V_{OUT}) \leq 40\text{V}$		0.2	5		0.2	5	μA
Temperature Stability	$T_{MIN} \leq T_J \leq T_{MAX}$		1			1		%
Minimum Load Current	$(V_{IN} - V_{OUT}) = 40\text{V}$		3.5	10		3.5	10	mA
Current Limit	$(V_{IN} - V_{OUT}) \leq 15\text{V}$ K, T, S Packages EMP Package H, MDT Packages	- 1.5 0.5	- 2.2 0.8	- 3.4 1.8	1.5 1.5 0.5	2.2 2.2 0.8	3.4 3.4 1.8	A
	$(V_{IN} - V_{OUT}) = 40\text{V}$ K, T, S Packages EMP Package H, MDT Packages	- 0.112 0.075	- 0.30 0.20		0.15 0.112 0.075	0.40 0.30 0.20		A
RMS Output Noise, % of V_{OUT}	$10\text{Hz} \leq f \leq 10\text{kHz}$		0.003			0.003		%
Ripple Rejection Ratio	$V_{OUT} = 10\text{V}$, $f = 120\text{Hz}$, $C_{ADJ} = 0\mu\text{F}$		65			65		dB
	$V_{OUT} = 10\text{V}$, $f = 120\text{Hz}$, $C_{ADJ} = 10\mu\text{F}$		66	80		66	80	dB
Long-Term Stability	$T_J = 125^\circ\text{C}$, 1000 hrs		0.3	1		0.3	1	%
Thermal Resistance, θ_{JC} Junction-to-Case	K (TO-3) Package		-			2		$^\circ\text{C/W}$
	T (TO-220) Package		-			4		
	S (TO-263) Package		-			4		
	EMP (SOT-223) Package		23.5			23.5		
	H (TO-39) Package		21			21		
	MDT (TO-252) Package		12			12		
Thermal Resistance, θ_{JA} Junction-to-Ambient (No Heat Sink)	K (TO-3) Package		-			39		$^\circ\text{C/W}$
	T (TO-220) Package		-			50		
	S (TO-263) Package (Note 6)		-			50		
	EMP (SOT-223) Package (Note 6)		140			140		
	H (TO-39) Package		186			186		
	MDT (TO-252) Package (Note 6)		103			103		

Note 1: Absolute Maximum Ratings indicate limits beyond which damage to the device may occur. Operating Ratings indicate conditions for which the device is intended to be functional, but do not guarantee specific performance limits. For guaranteed specifications and test conditions, see the Electrical Characteristics. The guaranteed specifications apply only for the test conditions listed.

Note 2: Refer to RETS117H drawing for the LM117H, or the RETS117K for the LM117K military specifications.

Note 3: $I_{MAX} = 1.5\text{A}$ for the K (TO-3), T (TO-220), and S (TO-263) packages. $I_{MAX} = 1.0\text{A}$ for the EMP (SOT-223) package. $I_{MAX} = 0.5\text{A}$ for the H (TO-39), MDT (TO-252), and E (LCC) packages. Device power dissipation (P_D) is limited by ambient temperature (T_A), device maximum junction temperature (T_J), and package thermal resistance (θ_{JA}). The maximum allowable power dissipation at any temperature is: $P_{D(MAX)} = ((T_{J(MAX)} - T_A)/\theta_{JA})$. All Min. and Max. limits are guaranteed to National's Average Outgoing Quality Level (AOQL).

Note 4: Regulation is measured at a constant junction temperature, using pulse testing with a low duty cycle. Changes in output voltage due to heating effects are covered under the specifications for thermal regulation.

Note 5: Human body model, 100 pF discharged through a 1.5 k Ω resistor.

Note 6: When surface mount packages are used (TO-263, SOT-223, TO-252), the junction to ambient thermal resistance can be reduced by increasing the PC board copper area that is thermally connected to the package. See the Applications Hints section for heatsink techniques.

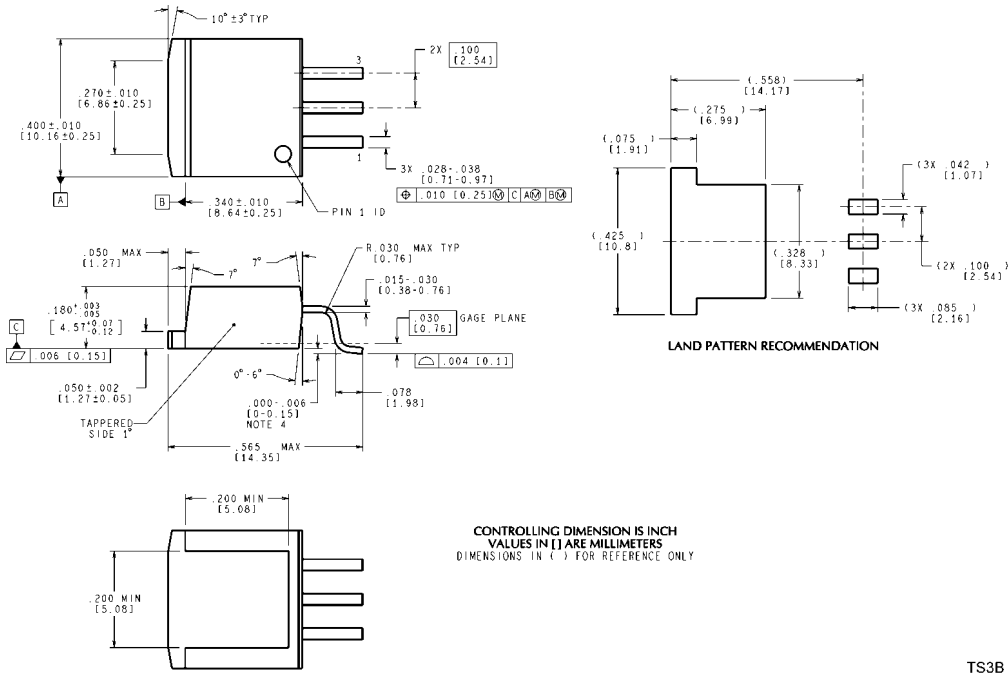

3-Lead TO-263 (S)
NS Package Number TS3B

TS3B (Rev F)

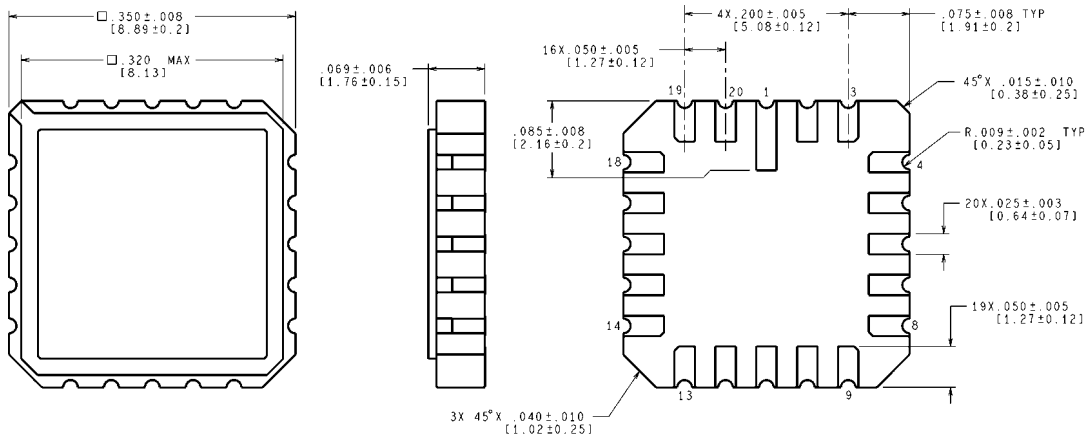

Ceramic Leadless Chip Carrier (E)
NS Package Number E20A

E20A (Rev F)

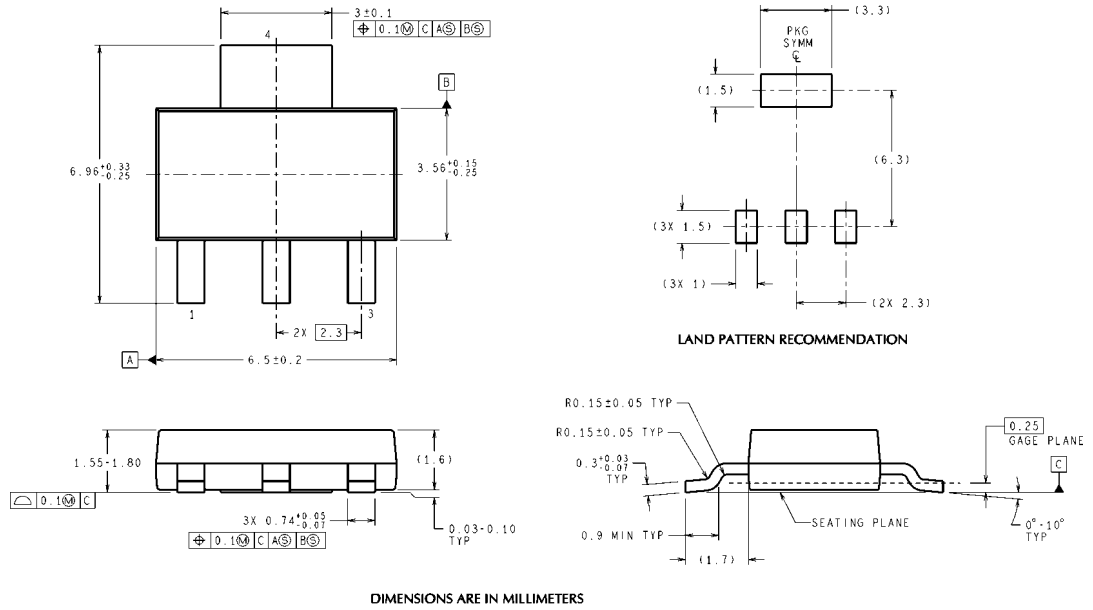

DIMENSIONS ARE IN MILLIMETERS

MP04A (Rev B)

**4-Lead SOT-223 (EMP)
NS Package Number MP04A**

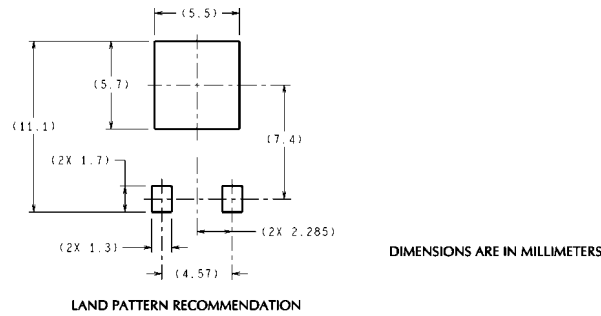

DIMENSIONS ARE IN MILLIMETERS

TD03B (Rev C)

**3-Lead D-Pack (MDT)
NS Package Number TD03B**

