

Solid-State Relays

Features

- Rugged, epoxy encapsulation construction
- 4,000 volts of optical isolation
- Subjected to full load test and six times the rated current surge before and after encapsulation
- Unique heat-spreader technology
- UL and CSA recognized*

Overview

In 1974, Opto 22 introduced the first liquid epoxy-filled line of power solid-state relays (SSR). This innovation in SSR design greatly improved the reliability and reduced the cost of manufacturing. At that time, we also incorporated into our manufacturing process 100% testing under full load conditions of every relay we produced.

By 1978, Opto 22 had gained such a reputation for reliability that we were recognized as the world's leading manufacturer of solid-state relays. Through continuous manufacturing improvements and the same 100% testing policy established over 30 years ago, Opto 22 is still recognized today for the very high quality and reliability of all our solid-state relays.

Part Numbers

Part	Description	Part	Description
120A10	120 VAC, 10 Amp, AC Control	480D10-12	480 VAC, 10 Amp, DC Control, Transient Proof
120A25	120 VAC, 25 Amp, AC Control	480D15-12	480 VAC, 15 Amp, DC Control, Transient Proof
240A10	240 VAC, 10 Amp, AC Control	480D25-12	480 VAC, 25 Amp, DC Control, Transient Proof
240A25	240 VAC, 25 Amp, AC Control	480D45-12	480 VAC, 45 Amp, DC Control, Transient Proof
240A45	240 VAC, 45 Amp, AC Control	575D15-12	575 VAC, 15 Amp, DC Control, Transient Proof
120D3	120 VAC, 3 Amp, DC Control	575D45-12	575 VAC, 45 Amp, DC Control, Transient Proof
120D10	120 VAC, 10 Amp, DC Control	575Di45-12	575 VAC, 45 Amp, DC Control, Transient Proof, with LED Indicators
120D25	120 VAC, 25 Amp, DC Control	Z120D10	Z Model, 120 VAC, 10 Amp, DC Control
120D45	120 VAC, 45 Amp, DC Control	Z240D10	Z Model, 240 VAC, 10 Amp, DC Control
240D3	240 VAC, 3 Amp, DC Control	MP120D2 or P120D2	120 VAC, 2 Amp, DC Control. P model is low profile.
240D10	240 VAC, 10 Amp, DC Control	MP120D4 or P120D4	120 VAC, 4 Amp, DC Control. P model is low profile.
240Di10	240 VAC, 10 Amp, DC Control, with LED Indicators	MP240D2 or P240D2	240 VAC, 2 Amp, DC. P model is low profile.
240D25	240 VAC, 25 Amp, DC Control	MP240D4 or P240D4	240 VAC, 4 Amp, DC. P model is low profile.
240Di25	240 VAC, 25 Amp, DC Control, with LED Indicators	MP380D4	380 VAC, 4 Amp, DC
240D45	240 VAC, 45 Amp, DC Control		
240Di45	240 VAC, 45 Amp, DC Control, with LED Indicators		
380D25	380 VAC, 25 Amp, DC Control		
380D45	380 VAC, 45 Amp, DC Control		

*UL recognition is pending for Power Series SSRs with LED indicators. Contact Opto 22 Product Support for current UL information.



Opto 22 Power Series SSR

Description

Opto 22 offers a complete line of SSRs, from the rugged 120/240/380-volt AC Series to the small footprint MP Series, designed for mounting on printed circuit boards. All Opto 22 SSRs feature 4,000 volts of optical isolation and are UL and CSA recognized.* The innovative use of room-temperature liquid epoxy encapsulation, coupled with Opto 22's unique heat-spreader technology, are key to mass producing the world's most reliable solid state relays.

Every Opto 22 solid state relay is subjected to full load test and six times the rated current surge both before and after encapsulation. This double testing of every part before it leaves the factory means you can rely on Opto 22 solid state relays. All Opto 22 SSRs are guaranteed for life.

Power Series SSRs



Opto 22 provides a full range of Power Series relays with a wide variety of voltage (120–575 volts) and current options (3–45 amps). All Power Series relays feature 4,000 volts of optical isolation and have a high PRV rating. Some Power Series relays include built-in LEDs to indicate operation.

DC Series

The DC Series delivers isolated DC control to large OEM customers worldwide.

AC Series

The AC Series offers the ultimate in solid state reliability. All AC Power Series relays feature a built-in snubber and zero voltage turn on. Transient-proof models offer self protection for noisy electrical environments.

Z Series SSRs



The Z Series employs a unique heat transfer system that makes it possible for Opto 22 to deliver a low-cost, 10-amp, solid state relay in an all-plastic case. The push-on, tool-free quick-connect terminals make the Z Series ideal for high-volume OEM applications.

Printed Circuit Series SSRs



Opto 22's Printed Circuit Series allows OEMs to easily deploy solid state relays on printed circuit boards. Two unique packages are available, both of which will switch loads up to four amps.

MP Series

The MP Series packaging is designed with a minimum footprint to allow maximum relay density on the printed circuit board.

P Series

The P Series power relays provide low-profile [0.5 in. (12.7 mm)] center mounting on printed circuit boards.

Solid-State Relays

Specifications (all Power Series models)

- 4,000 V optical isolation, input to output
- Zero voltage turn-on
- Turn-on time: 0.5 cycle maximum
- Turn-off time: 0.5 cycle maximum
- Operating frequency: 25 to 65 Hz (operates at 400 Hz with six times off-state leakage)
- Coupling capacitance, input to output: 8 pF maximum
- Hermetically sealed
- DV/DT Off-state: 200 volts per microsecond
- DV/DT commutating: snubbed for rated current at 0.5 power factor
- UL recognized*
- CSA certified
- CE component

See Opto 22 form #986 for torque specifications.

Safety Cover for Power Series SSRs

A plastic safety cover (Opto 22 part number SAFETY COVER) is optionally available for Opto 22 Power Series SSRs. The safety cover reduces the chance of accidental contact with relay terminals, while providing access holes for test instrumentation.

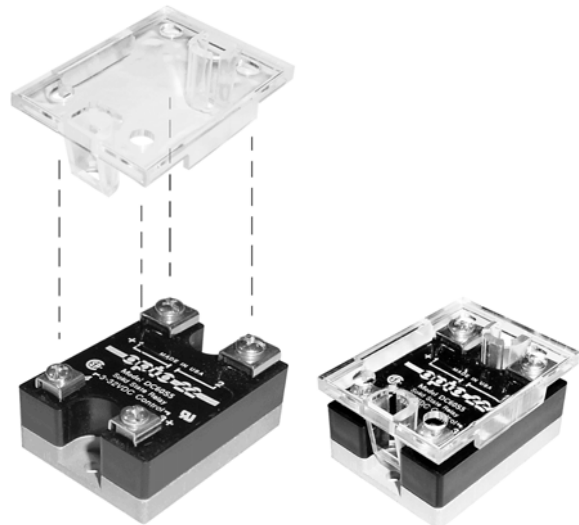

An optional plastic safety cover can be installed on a Power Series SSR.

*UL recognition is pending for Power Series SSRs with LED indicators. Contact Opto 22 Product Support for current UL information.

Solid-State Relays

AC Power Series Specifications

Opto 22 provides a full range of Power Series relays with a wide variety of voltage (120–575) and current options (3–45 amps). All Power Series relays feature 4,000 volts of optical isolation and have a high PRV rating.

120/240/380 Volt

Model Number	Nominal AC Line Voltage	Nominal Current Rating (Amps)	1 cycle Surge (Amps) Peak	Nominal Signal Input Resistance (Ohms)	Signal Pick-up Voltage	Signal Drop-out Voltage	Peak Repetitive Voltage Maximum	Maximum Output Voltage Drop	Off-State Leakage (mA) Maximum**	Operating Voltage Range (Volts AC)	τ^2 Rating $t=8.3$ (ms)	Isolation Voltage	θ_{jc}^* ($^{\circ}$ C/Watt)	Dissipation (Watts/ Amp)
120D3	120	3	85	1000	3VDC (32V allowed)	1 VDC	600	1.6 volts	2.5mA	12–140	30	4,000V _{RMS}	11	1.7
120D10	120	10	110	1000	3VDC (32V allowed)	1 VDC	600	1.6 volts	7 mA	12–140	50	4,000V _{RMS}	1.3	1.6
120D25	120	25	250	1000	3VDC (32V allowed)	1 VDC	600	1.6 volts	7 mA	12–140	250	4,000V _{RMS}	1.2	1.3
120D45	120	45	650	1000	3VDC (32V allowed)	1 VDC	600	1.6 volts	7 mA	12–140	1750	4,000V _{RMS}	0.67	0.9
240D3	240	3	85	1000	3VDC (32V allowed)	1 VDC	600	1.6 volts	5 mA	24–280	30	4,000V _{RMS}	11	1.7
240D10	240	10	110	1000	3VDC (32V allowed)	1 VDC	600	1.6 volts	14 mA	24–280	50	4,000V _{RMS}	1.3	1.6
240D110	240	10	110	730	3VDC (32V allowed)	1 VDC	600	1.6 volts	14 mA	24–280	50	4,000V _{RMS}	1.3	1.6
240D25	240	25	250	1000	3VDC (32V allowed)	1 VDC	600	1.6 volts	14 mA	24–280	250	4,000V _{RMS}	1.2	1.3
240Di25	240	25	250	730	3VDC (32V allowed)	1 VDC	600	1.6 volts	14 mA	24–280	250	4,000V _{RMS}	1.2	1.3
240D45	240	45	650	1000	3VDC (32V allowed)	1 VDC	600	1.6 volts	14 mA	24–280	1750	4,000V _{RMS}	0.67	0.9
240Di45	240	45	650	730	3VDC (32V allowed)	1 VDC	600	1.6 volts	14 mA	24–280	1750	4,000V _{RMS}	0.67	0.9
380D25	380	25	250	1000	3VDC (32V allowed)	1 VDC	800	1.6 volts	12 mA	24–420	250	4,000V _{RMS}	1.2	1.3
380D45	380	45	650	1000	3VDC (32V allowed)	1 VDC	800	1.6 volts	12 mA	24–420	1750	4,000V _{RMS}	0.67	0.9
120A10	120	10	110	33K	85VAC (280V allowed)	10 VAC	600	1.6 volts	7 mA	12–140	50	4,000V _{RMS}	1.3	1.6
120A25	120	25	250	33K	85VAC (280V allowed)	10 VAC	600	1.6 volts	7 mA	12–140	250	4,000V _{RMS}	1.2	1.3
240A10	240	10	110	33K	85VAC (280V allowed)	10 VAC	600	1.6 volts	14 mA	24–280	50	4,000V _{RMS}	1.3	1.6
240A25	240	25	250	33K	85VAC (280V allowed)	10 VAC	600	1.6 volts	14 mA	24–280	250	4,000V _{RMS}	1.2	1.3
240A45	240	45	650	33K	85VAC (280V allowed)	10 VAC	600	1.6 volts	14 mA	24–280	1750	4,000V _{RMS}	0.67	0.9

Note: θ_{jc}^* = Thermal resistance junction to base. Maximum junction temperature is 110 $^{\circ}$ C.

** Operating Frequency: 25 to 65 Hz (operates at 400 Hz with 6 times the offstate leakage)

AC Power Series Specifications

120/240/380 Volt (cont.)

Surge Current Data

Time (Seconds)	Time* (Cycles)	3-Amp Peak Amps	10-Amp Peak Amps	25-Amp Peak Amps	45-Amp Peak Amps
0.017	1	85	110	250	650
0.050	3	66	85	175	420
0.100	6	53	70	140	320
0.200	12	45	60	112	245
0.500	30	37	50	80	175
1	60	31	40	67	134
2	120	28	33	53	119
3	180	27	32	49	98
4	240	26	31	47	95
5	300	25	30	45	91
10	600	24	28	42	84

Note: *60 Hz.

Dimensional Drawings

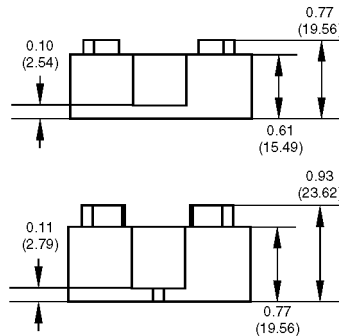
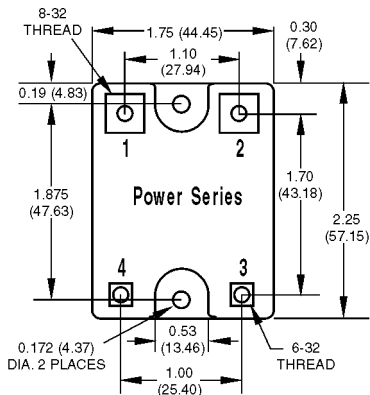

Solid-State Relays

Thermal Ratings

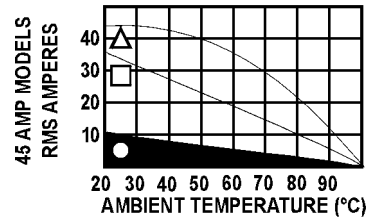
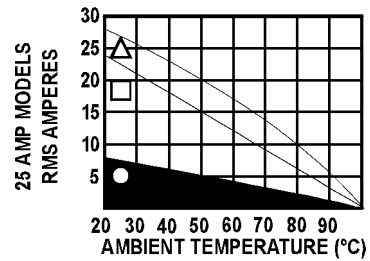
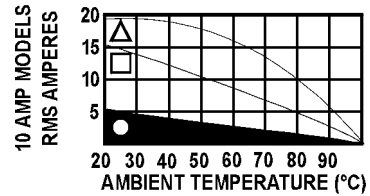
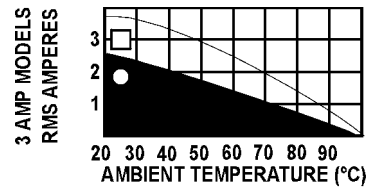

- FREE AIR
- MOUNTED ON 6" X 6" PLATE (2°c/watt)
- △ MOUNTED ON 12" X 12" PLATE (1°c/watt)

Side view: Part numbers DC60S3, 120D3, and 240D3 only

Side view: All other part numbers

Solid-State Relays

Applications: Tips (cont.)

Transformer Loads

Careful consideration should be given to the selection of the proper SSR for driving a given transformer. Transformers are driven from positive saturation of the iron core to negative saturation of the core each half cycle of the alternating voltage. Large inrush currents can occur during the first half cycle of line voltage if a zero-voltage SSR happens to turn on during the positive half cycle of voltage when the core is already in positive saturation. Inrush currents greater than 10 times rated transformer current can easily occur. The following table provides a guide for selecting the proper SSR for a given transformer rating.

120-Volt Transformers	
SSR MODEL	TRANSFORMER
P or MP 120D2	100 VA
Z120D10	500 VA
120D3	100 VA
P or MP 120D4	250 VA
120D10 or 120A10	500 VA
120D25 or 120A25	1 KVA
120D45	2 KVA
240-Volt Transformers	
P or MP240D2	200 VA
7240D10	1 KVA
120D3	200 VA
P or MP240D4	500 VA
240D10 or 240A10	1 KVA
240D25 or 240A25	2 KVA
240D45	4 KVA
480-Volt Transformers	
SSR MODEL	TRANSFORMER
480D10-12	5-Amp Primary
480D15-12	5-Amp Primary

Solenoid Valve and Contactor Loads

All Opto 22 SSRs are designed to drive inductive loads such as solenoid valves and electromechanical contactors. The built-in snubber in each SSR assures proper operation into inductive loads. The following table is a guide in selecting an SSR to drive a solenoid or contactor.

120-Volt Coils		
SSR CURRENT RATING	SOLENOID	CONTACTOR
2-Amp	1-Amp	NEMA Size 4
4-Amp	3-Amp	NEMA Size 7
240-Volt Coils		
SSR CURRENT RATING	SOLENOID	CONTACTOR
2-Amp	1-Amp	NEMA Size 7
4-Amp	3-Amp	NEMA Size 7

Control Current Calculation

All Opto 22 DC-controlled SSRs have a control circuit consisting of 1000 ohms in series with an LED. Since 3 volts is required to turn on any SSR, the maximum current required is (3 volt - 1 volt) divided by 1000 ohms, which equals 2.0 mA. The 1 volt is subtracted from the 3 volt signal because 1 volt is dropped across the LED. For higher control voltages, an external resistor can be added in series with the control voltage to limit the control current. To limit the control current to 2 mA, calculate the external resistor $R_c = 500 (E_c - 3)$ where E_c = the control voltage.

The DC control voltage range is 3–32 VDC. To calculate the control current for any voltage within the 3–32 VDC range, use the formula:

$$I_c = \frac{E_c - 1}{1000}$$

where $R_c = \text{zero}$.

With a 5V control signal,

$$I_c = \frac{5 - 1}{1000} = 4 \text{ mA}$$

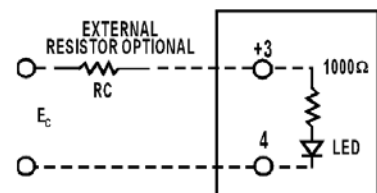

Applications: Tips (cont.)

Opto 22 SSRs for controlling single-phase motors are shown in the following tables:

120-Volt Single-Phase Non-Reversing Motors	
SSR Model	MOTOR RATING
P or MP120D2	1 Amp
Z120D10	1/4 HP
120D3	1-1/2 Amp
P or MP120D4	1-1/2 Amp
120D10 or 120A10	1/4 HP
120D25 or 120A25	1/3 HP
120D45	3/4 HP

240-Volt Single Phase Non-Reversing Motors	
SSR Model	MOTOR RATING
P or MP240D2	1 Amp
Z240D10	1/4 HP
240D3	1-1/2 Amp
P or MP240D4	1-1/2 Amp
240D10 or 240A10	1/3 HP
240D25 or 120A25	1/2 HP
240D45	1-1/2 HP

120-Volt Single-Phase Reversing Motors	
SSR Model	MOTOR RATING
P or MP240D2	1 Amp
Z240D10	1/4 HP
240D3	1-1/2 Amp
P or MP240D4	1-1/2 Amp
240D10 or 240A10	1/4 HP
240D25 or 120A25	1/3 HP
240D45	3/4 HP

Solid-State Relays

240-Volt Single-Phase Reversing Motors	
SSR Model	MOTOR RATING
480D10-12	1/4 HP
480D15-12	1/4 HP

Solid-State Relays in Series

In applications requiring greater current rating at higher voltage, two Opto 22 SSRs may be operated in series for double the voltage rating. The built-in snubber in each SSR assures proper voltage sharing of the two SSRs in series. In the following diagram, two 240-volt, 45-amp SSRs are connected in series for operation on a 480-volt line. The control is shown with a parallel hook-up but it should be noted that a serial connection can also be implemented.

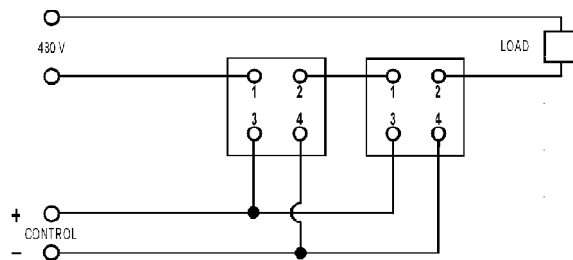

Lamp Loads

Since all Opto 22 SSRs are zero-voltage switching, they are ideal for driving incandescent lamps, because the initial inrush current into a cold filament is reduced. The life of the lamp is increased when switched by a zero-voltage turn-on SSR. The following table is a guide to selecting an Opto 22 SSR for switching a given incandescent lamp.

120 Volt Lamps	
SSR CURRENT RATING	LAMP RATING
2-Amp	100 Watt
4-Amp	400 Watt
10-Amp	1 Kilowatt
25-Amp	2 Kilowatt
45-Amp	3 Kilowatt
240 Volt Rating	
SSR CURRENT RATING	LAMP RATING
2-Amp	200 Watt
4-Amp	800 Watt
10-Amp	2 Kilowatt
25-Amp	4 Kilowatt
45-Amp	6 Kilowatt

Applications: Tips (cont.)

Three-Phase Motor Control

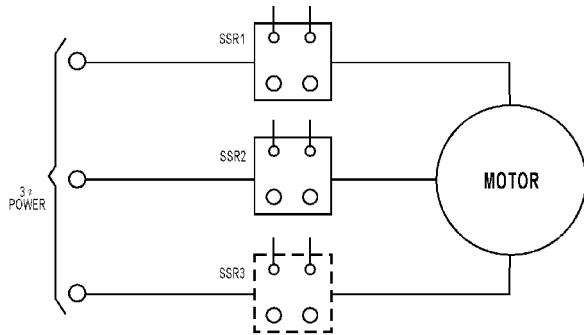

Three-phase motors may be controlled by solid-state relays as shown. A third SSR as shown is optional, but not necessary. The control windings may be connected in series or parallel. Care should be taken to ensure that the surge current drawn by the motor does not exceed the surge current rating of the SSR.

240 Volt Three-Phase Motor	
SSR MODEL	MOTOR
Z240D25	1/3 HP
Z240D10	3/4 HP
240D10	3/4 HP
240A10	3/4 HP
240D25	2 HP
240A25	2 HP
240D45	3 HP
480 Volt Three-Phase Motors	
SSR MODEL	MOTOR
480D10-12	1-½ HP
480D15-12	1-½ HP

Solid-State Relays

Three-Phase Reversing Motor Control

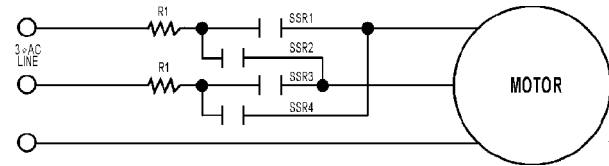

Three-phase reversing motor control can be implemented with four SSRs as shown in the connection diagram. The SSRs work in pairs with SSR1 and SSR3 operated for rotation in one direction and SSR2 and SSR4 operated for rotation in the reverse direction. The resistor R1 as shown in the connection diagram protects against line-to-line shorts if SSR1 and SSR4 or SSR3 and SSR2 are on at the same time during the reversing transition period. Use the following table as a guide to the proper selection of an SSR for this application.

Opto 22 Relay	Motor Full Load Rating	Resistor for 120V line	Resistor for 240V line
3-Amp	1.25-Amp	4 ohm 50 W	8 ohm 50 W
10-Amp	5-Amp	1 ohm 100 W	2 ohm 100 W
25-Amp	8-Amp	.5 ohm 100 W	1 ohm 100 W
45-Amp	16-Amp	.25 ohm 150 W	.5 ohm 150 W
15-Amp	5-Amp	1 ohm 100 W	2 ohm 100 W