

Cooper Bussmann

- Homepage
- About Cooper Bussmann
- Contact Us
- Privacy
- Legal
- Cooper Bussmann® Brand
- Site Map

GMA-3A

Fast Acting, 5 X 20 MM, Glass Tube Fuse

Product Information

Product Type:	Fuse
Product Family:	Electronic
Brand:	Cooper Bussmann

Recommended Products

Rec. Fuse Block:	HTC-15M
Rec. Inline Fuse Holder:	HHT
Rec. Panel-mount Fuse Holder:	HTB Series
Rec. Fuse Clips:	1A3399 Series

Physical Properties

Dimensions:	0.79in.(L) × 0.19in.(W) × 0in.(H)
-------------	-----------------------------------

Electrical Properties

Maximum AC Voltage:	250
Amperage Rating:	3
AC Interrupting Ratings:	<ul style="list-style-type: none"> • 100 at 250V • 10000 at 125V
Melting I ² T:	8.8
Fast Acting:	Yes
Resistance:	0.039
Voltage Drop:	215

Description

- Fast acting, low breaking capacity
- Optional axial leads available
- 5mm x 20mm physical size
- Glass tube, nickel-plated brass endcap construction
- Designed to UL/CSA 248-14

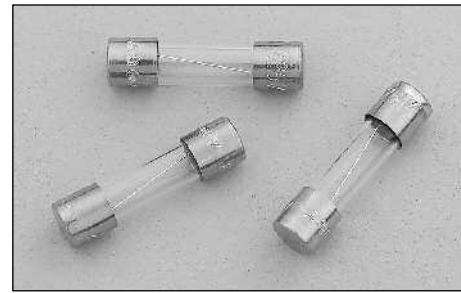

ELECTRICAL CHARACTERISTICS		
Rated Current	% of Amp Rating	Opening Time
63mA - 10A	100%	None
	135%	60 minutes maximum
	200%	2 minutes maximum

Agency Information

- UL Listed, Guide JDYX, File E19180, 63mA-6A
- UL Recognized Card: (7A-15A) Guide JDYX2, File E19180
- CSA Certified, Class 1422-01, File E65063, 63mA-6A
- MITI Approval, 1A-15A
- CCC Approval, 63mA-6A

Ordering

- Specify packaging, product, and option code
- For -R option, drop mA or A from product code (i.e. GMA-2-R)

Dimensions mm/(inches)

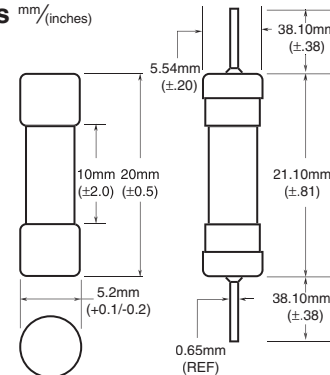

- Ratings above 6.3A have a 0.8mm diameter lead
- With TR2 packaging code, lead wire length is 19.05mm

SPECIFICATIONS						
Product Code	Voltage Rating AC	AC Interrupting Rating*		Typical DC Cold Resistance (ohms)**	Typical Pre-Arc I [†] t AC†	Maximum Voltage Drop (mV)‡
		250V	125V			
GMA-63mA	250V	35A	10,000A	-	0.00024	4700
GMA-100mA	250V	35A	10,000A	-	0.0001	4300
GMA-125mA	250V	35A	10,000A	-	0.0024	2600
GMA-200mA	250V	35A	10,000A	-	0.001	3400
GMA-250mA	250V	35A	10,000A	-	0.018	2200
GMA-300mA	250V	35A	10,000A	-	0.019	470
GMA-315mA	250V	35A	10,000A	-	0.019	450
GMA-500mA	250V	35A	10,000A	0.454	0.15	230
GMA-600mA	250V	35A	10,000A	0.256	0.32	200
GMA-750mA	250V	35A	10,000A	0.186	0.47	200
GMA-800mA	250V	35A	10,000A	0.170	0.70	180
GMA-1A	250V	35A	10,000A	0.163	0.48	300
GMA-1.25A	250V	100A	10,000A	0.122	0.84	290
GMA-1.5A	250V	100A	10,000A	0.090	1.6	270
GMA-1.6A	250V	100A	10,000A	0.080	2.0	260
GMA-2A	250V	100A	10,000A	0.066	3.1	250
GMA-2.5A	250V	100A	10,000A	0.046	4.9	240
GMA-3A	250V	100A	10,000A	0.039	8.8	215
GMA-3.15A	125V	-	10,000A	0.036	9.7	210
GMA-3.5A	125V	-	10,000A	0.030	13	210
GMA-4A	125V	-	10,000A	0.026	19	205
GMA-5A	125V	-	10,000A	0.021	29	200
GMA-6A	125V	-	10,000A	0.017	45	180
GMA-7A	125V	-	200A	0.012	150	110
GMA-8A	125V	-	200A	0.009	280	110
GMA-10A	125V	-	200A	0.006	280	110
GMA-15A	125V	-	150A	0.004	950	100

* Interrupting ratings: Interrupting ratings for 63mA - 6A were measured at 70% - 80% power factor on AC. The interrupting ratings for 7A - 15A were measured at 100% power factor on AC.

** DC Cold Resistance (Measured at <10% of rated current)

† Typical Pre-Arching I[†]t (I[†]t was measured at listed interrupting rating and rated voltage)

‡ Maximum Voltage drop (Voltage drop was measured at 20°C ambient temperature at rated current)

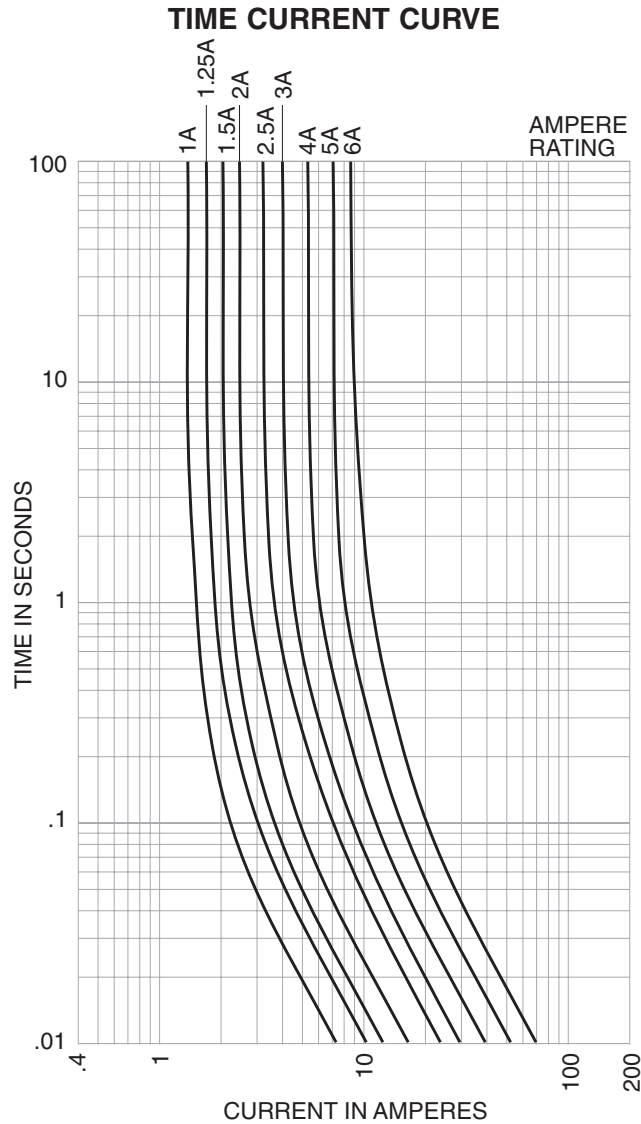

PACKAGING CODE	
Packaging Code	Description
BK	100 pieces of fuses packed into a cardboard carton
BK1	1,000 pieces of fuses packed into a poly bag
TR2	1,500 pieces of fuses packed into tape on a reel (19.05mm lead wire length)

OPTION CODE	
Option Code	Description
V	Axial leads - copper tinned wire with nickel plated brass overcaps
-R	RoHS compliant version