

Multifunctional Through Hole DIP Switches

Features

Optimized Mechanical Features

- Standard 2.54mm (.100") x 7.62mm (.300") DIP centers
- Available with flush actuators for low profile SPST & SPDT applications
- Sealed version optional; assures contaminant-free switch operation after wave soldering and cleaning
- Available with low profile, standard, or extended actuators

Optimized Contact System

- Contact wiping action on make and break
- Integral terminal and contact locked into thermoset base
- Electrostatic discharge shield rated to 22 KV

Materials

- Series 206, gold plated copper alloy contacts
- Series 208, solder coated, copper alloy contacts
- All UL 94 V-0 plastics used
- RoHS compliant

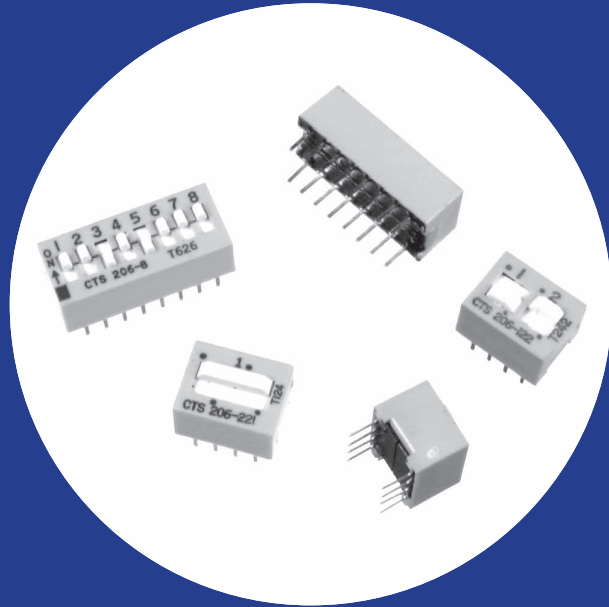

Series 206 – Premium Programmable DIP Switch
Series 208 – Economical Programmable DIP Switch

Electrical and Mechanical Specifications

Switch Function

- SPST - 1 through 10 and 12 positions
- SPDT&DPST- 1 through 6 positions
- DPDT&4PST - 1 through 3 positions
- 3PST - 1 through 4 positions

Switch Contact Resistance

Switch Series	Initial, max.	End of life, max.
206	50 milliohms	100 milliohms
208	100 milliohms	500 milliohms

Insulation Resistance

- 1,000 megohms minimum across open switch
- 1,000 megohms minimum between adjacent closed switches

Dielectric Strength

- 500 VAC minimum for 1 minute between adjacent switches

Nonswitching Rating

- 100 mA or 50 VDC maximum

Switch Capacitance

- 5.0 pF maximum between adjacent closed switches

Operating Temperature

- 55°C to +85°C

Actuation Life

- Series 206: 10,000 cycles switching
50 mA @ 24 VDC
- Series 208: 2,000 cycles switching
50 mA @ 24 VDC

Allowable Solder Time

- Up to 5 seconds with 260°C

Vibration

- Per MIL-STD-202F, method 204D, condition B with no contact inconsistencies greater than 1 microsecond

Shock

- Per MIL-STD-202F, method 213B, condition A with no contact inconsistencies greater than 1 microsecond

Sealing

- Optional bottom epoxy seal
- Optional top tape seal

Marking

- Special side or top marking available-consult CTS

Packaging

- Standard : Anti-Static tube packaging

SPST Series 206/208

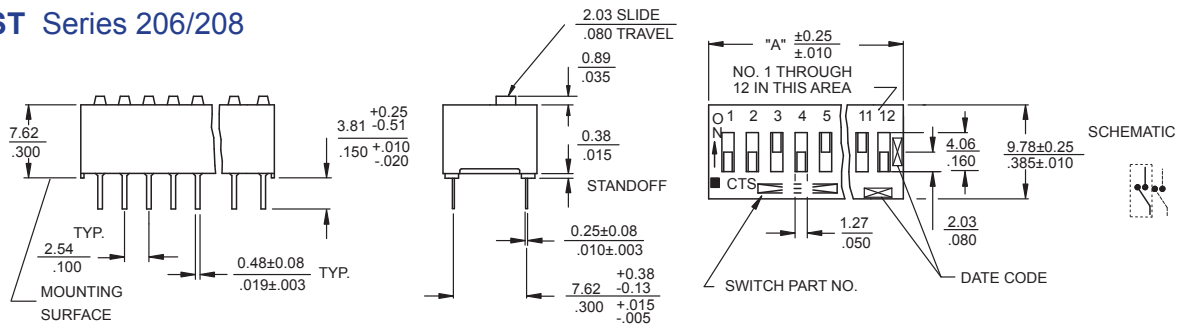

DIMENSION: $\frac{\text{mm}}{\text{inch}}$

SPDT / DPST Series 206/208

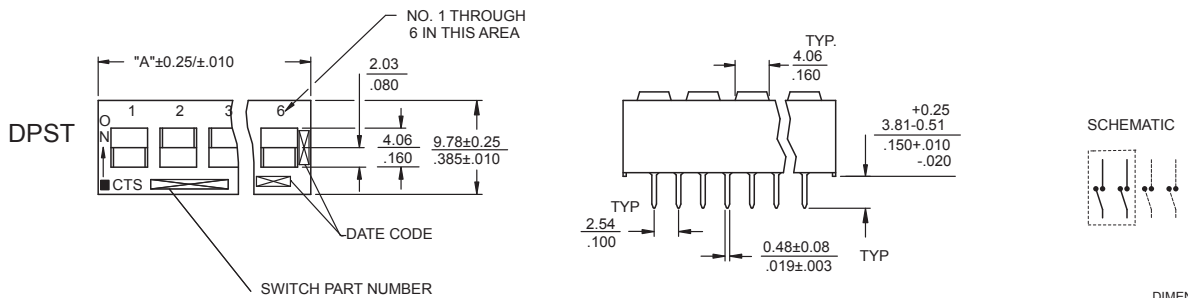
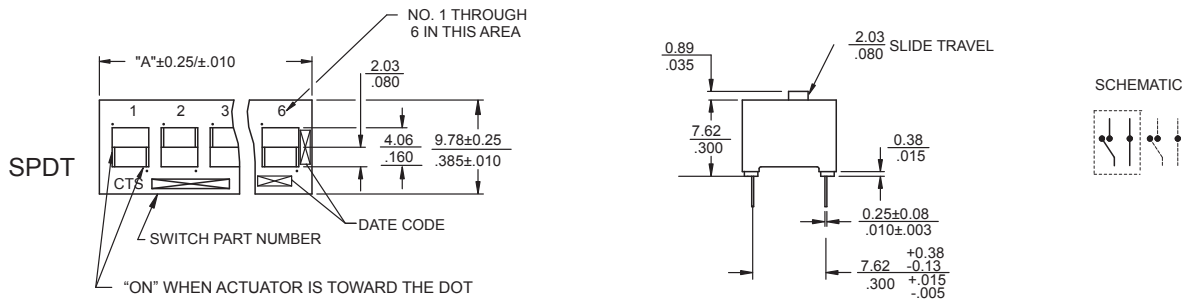

DIMENSION: $\frac{\text{mm}}{\text{inch}}$

DPDT / 4PST Series 206/208

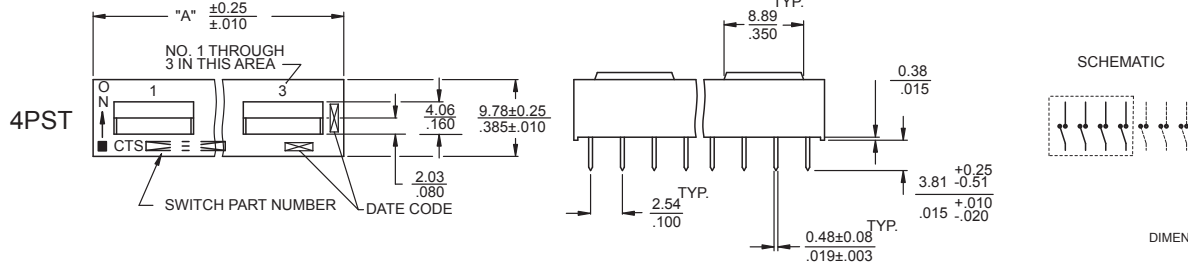
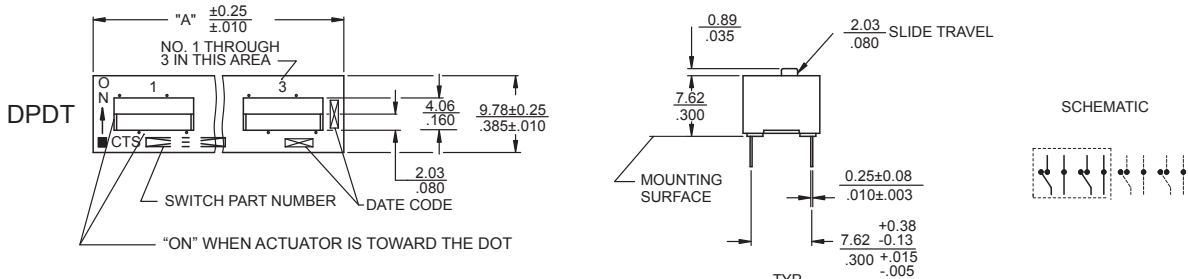

DIMENSION: $\frac{\text{mm}}{\text{inch}}$

3PST Series 206/208

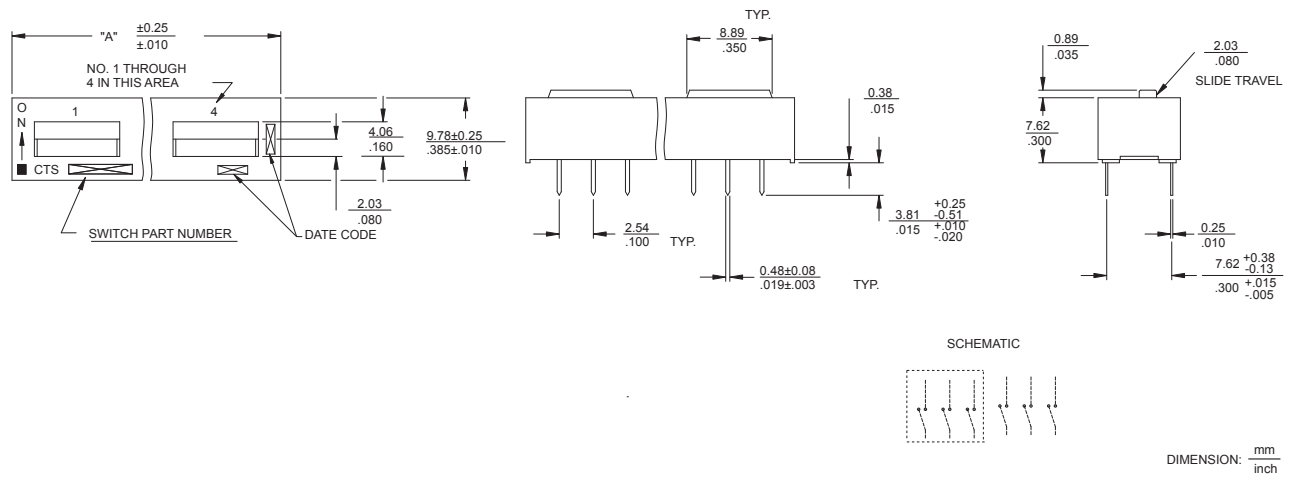

Low Profile Actuators Series 206/208 (SPST & SPDT only)

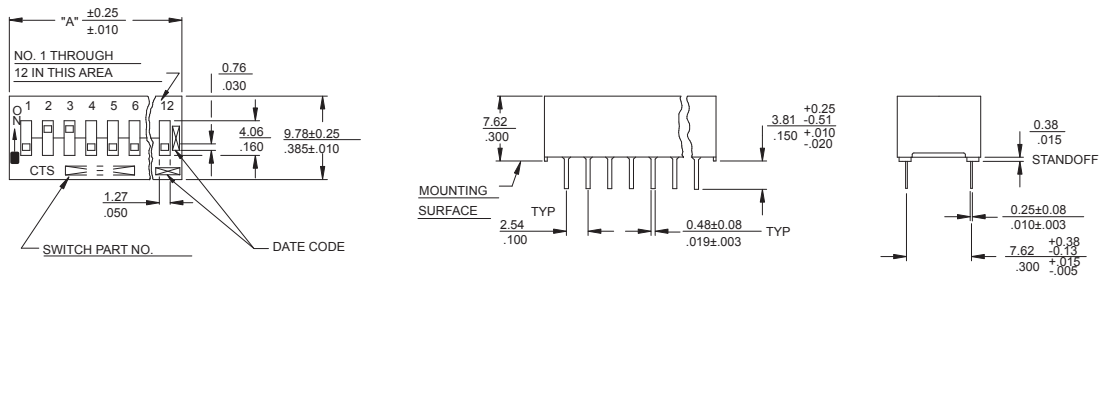

Extended Actuators Series 206/208 (SPST & SPDT only)

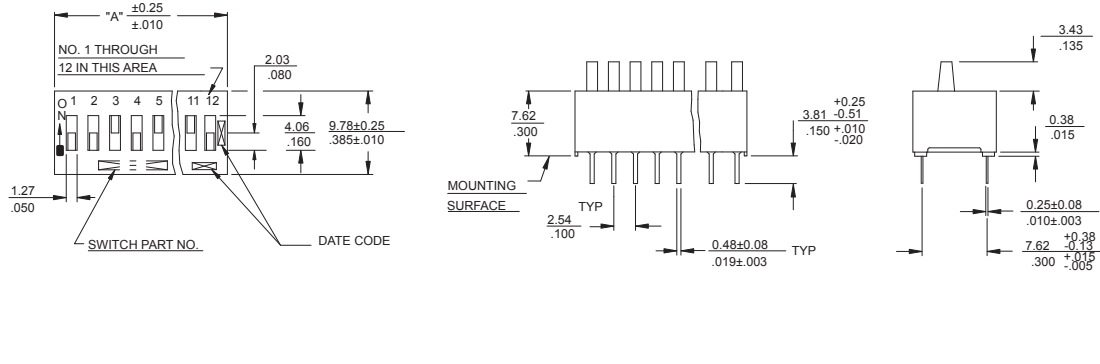

Ordering Information

206/208 - 1 2 1 E S T N - P

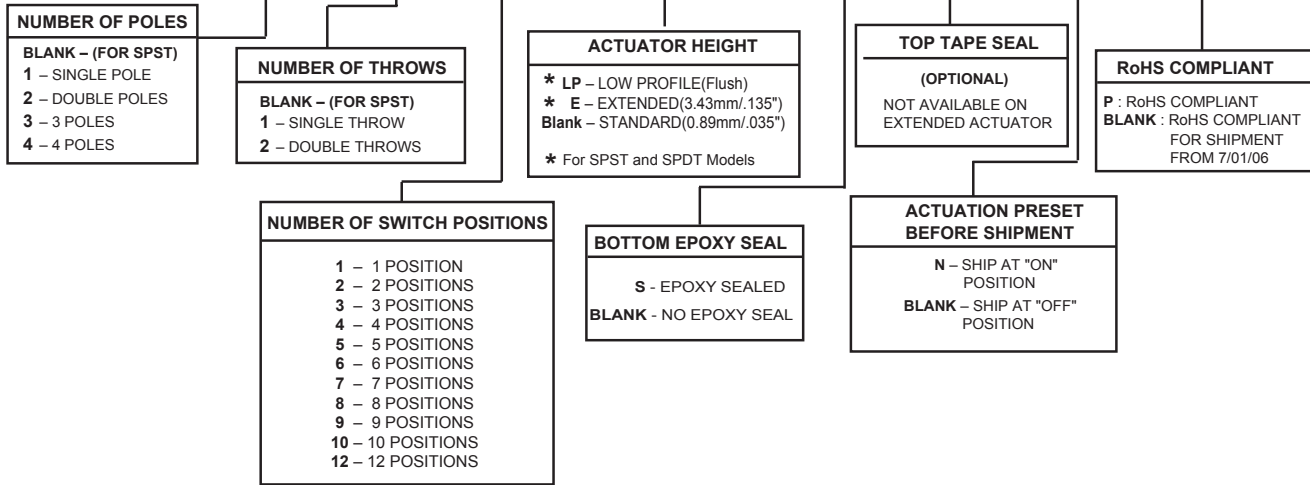

"A" Overall Dimensions	Number of Switch Positions	Actuation	Part Number	Both Bottom and Top Sealed	Low Profile Both Bottom and Top Sealed
3.96 / .156	1	SPST	206/208-1	206/208-1ST	206/208-1LPST
7.26 / .286	2	SPST	206/208-2	206/208-2ST	206/208-2LPST
9.80 / .386	3	SPST	206/208-3	206/208-3ST	206/208-3LPST
12.34 / .486	4	SPST	206/208-4	206/208-4ST	206/208-4LPST
14.88 / .586	5	SPST	206/208-5	206/208-5ST	206/208-5LPST
17.42 / .686	6	SPST	206/208-6	206/208-6ST	206/208-6LPST
19.96 / .786	7	SPST	206/208-7	206/208-7ST	206/208-7LPST
22.50 / .886	8	SPST	206/208-8	206/208-8ST	206/208-8LPST
25.04 / .986	9	SPST	206/208-9	206/208-9ST	206/208-9LPST
27.58 / 1.086	10	SPST	206/208-10	206/208-10ST	206/208-10LPST
32.66 / 1.286	12	SPST	206/208-12	206/208-12ST	206/208-12LPST
7.26 / .286	1	SPDT	206-121	206-121ST	206/208-121LPST
12.34 / .486	2	SPDT	206-122	206-122ST	206/208-122LPST
17.42 / .686	3	SPDT	206-123	206-123ST	206/208-123LPST
22.50 / .886	4	SPDT	206-124	206-124ST	206/208-124LPST
27.58 / 1.086	5	SPDT	206-125	206-125ST	206/208-125LPST
32.66 / 1.286	6	SPDT	206-126	206-126ST	206/208-126LPST
7.26 / .286	1	DPST	206-211	206-211ST	
12.34 / .486	2	DPST	206-212	206-212ST	
17.42 / .686	3	DPST	206-213	206-213ST	
22.50 / .886	4	DPST	206-214	206-214ST	
27.58 / 1.086	5	DPST	206-215	206-215ST	
32.66 / 1.286	6	DPST	206-216	206-216ST	
12.34 / .486	1	DPDT	206-221	206-221ST	
22.50 / .886	2	DPDT	206-222	206-222ST	
32.66 / 1.286	3	DPDT	206-223	206-223ST	
9.80 / .386	1	3PST	206-311	206-311ST	
17.42 / .686	2	3PST	206-312	206-312ST	
25.04 / .986	3	3PST	206-313	206-313ST	
32.66 / 1.286	4	3PST	206-314	206-314ST	
12.34 / .486	1	4PST	206-411	206-411ST	
22.50 / .886	2	4PST	206-412	206-412ST	
32.66 / 1.286	3	4PST	206-413	206-413ST	