

Features:

- ✓ Small size, minimal footprint – SMT/SIP package
- ✓ 16A Output Current (all voltages)
- ✓ High Efficiency: up to 95%
- ✓ High reliability
- ✓ RoHS Compliant
- ✓ Cost efficient open frame design
- ✓ Output voltage programmable by an external resistor.
- ✓ Monotonic Startup with Pre-Bias
- ✓ +’ve Enable Logic and –’ve Enable Logic models available
- ✓ Optional Power Good Signal
- ✓ Sequencing / Tracking Feature

Output				Input				Efficiency	
Vout (V)	Iout (A)	PARD (mVp-p)		Regulation Max		Vin Nom. (V)	Range (V)	Iin Typ (A)	Full Load Typ.
		Typ.	Max.	Line	Load				
0.75	16	50	75	+/-0.2%	+/-0.5%	12	6.0 – 14	1.299	77%
1.2	16	50	75	+/-0.2%	+/-0.5%	12	6.0 – 14	1.928	83%
1.5	16	50	75	+/-0.2%	+/-0.5%	12	6.0 – 14	2.326	86%
1.8	16	50	75	+/-0.2%	+/-0.5%	12	6.0 – 14	2.727	88%
2.0	16	50	75	+/-0.2%	+/-0.5%	12	6.0 – 14	2.996	89%
2.5	16	50	75	+/-0.2%	+/-0.5%	12	6.0 – 14	3.704	90%
3.3	16	50	75	+/-0.2%	+/-0.5%	12	6.0 – 14	4.783	92%
5.0	16	50	75	+/-0.2%	+/-0.5%	12	6.5 – 14	7.092	94%



Input Characteristics	Notes & Conditions	Min	Typ.	Max	Units
Input Voltage Operating Range	Minimum 6.5 V input @ 5 volts output	6.0	12	14	Vdc
Input Reflected Ripple Current			200		mA _{p-p}
Inrush Current Transient				0.2	A ² s
Input Filter Type (external)			100		μF
Input Turn ON Threshold			5.0		V
Input Turn OFF Threshold			4.0		V
Enable (Positive enable has 20K pullup) (Negative enable has no internal pullup resistor)	Positive enable: ON		open		
	Positive enable: OFF		<0.4		Vdc
	Negative enable: ON; open circuit or		<0.4		Vdc
	Negative enable: OFF	2		V _{in}	

Output Characteristics	Notes & Conditions	Min	Typ.	Max	Units
Vout Accuracy	100% load	-1.5		+1.5	%
Output Loading		0		16	A
Output Ripple & Noise @ 20Mhz Bandwidth.				75	mVp-p
Maximum Capacitive Load	Low ESR			8000	μF
Vout Trim Range (Nom)		0.75		5.0	V
Total Accuracy	Over line/load temperature		<2%		
Current Limit			23		A
Output Line Regulation		-0.2		+0.2	%
Output Load Regulation		-0.5		+0.5	%
Turn-on Overshoot				1	%
SC Protection Technique	Hiccup with auto recovery				
Pre-bias Start-up at output	Unit starts monotonically with pre-bias				

Dynamic Characteristics	Notes & Conditions	Min	Typ.	Max	Units
Load Transient	50% step, 0.1A/μs			100	mV
	Settling Time			200	μs
Operating Frequency			300		KHz
Rise Time	10% V _o to 90% V _o		3.5		ms
Start-Up Time	V _{in} to V _{out} and On/Off to V _{out}		7		ms

General Specifications	Notes & Conditions	Min	Typ.	Max	Units
MTBF	Calculated (MIL-HDBK-217F)		919.53		kHrs
Thermal Protection	Hotspot		110		°C
Operating Temperature	Without derating 300LFM	-40		50	°C
Operating Ambient Temperature	See Power derating curve	-40		85	°C
SIP Dimensions	2"Lx0.327"Wx0.512"H (50.8x8.3x13.0mm)				
SMT Dimensions	1.30"Lx0.53"Wx0.366"H (33x13.46x9.3mm)				
SIP Pin Dimensions	0.025" (0.64mm) SQUARE		0.64		mm
SMT Block Dimensions	0.063" x 0.065" x 0.112" SQUARE				
Pin and Block Material	Matte Sn Finish on component Leads				
Flammability Rating	UL94V-0				

Standards Compliance
CSA C22.2, No.60950/UL 60950, Third Edition (2000), File UL E165113

Thermal Considerations

The power module operates in a variety of thermal environments; however, sufficient cooling should be provided to help ensure reliable operation of the unit.

The thermal data presented is based on measurements taken at various airflows. Note that airflow is parallel to the long axis of the module as shown in Figure 1 and derating applies accordingly.

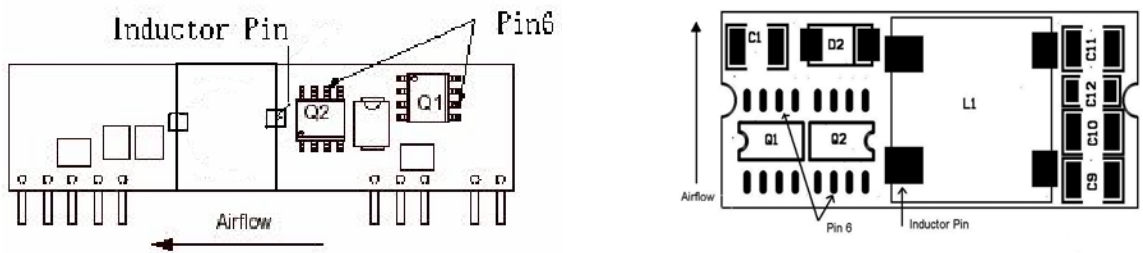

Figure 1. Thermal Tests Set-Up.

The temperature at either location should not exceed 110°C. Over-temperature shutdown is evaluated at these locations. The output power of the module should not exceed the rated power for the module ($V_{o,set} \times I_{o,max}$).

Convection Requirements for Cooling

To predict the approximate cooling needed for the module, refer to the Power Derating Curves in Figures 2-17 .

These derating curve are approximations of the ambient temperature and airflow required to keep the power module temperature below it's maximum rating. Once the module is assembled in the actual system, the module's temperature should be verified.

TYPICAL DERATING CURVES SIP/SMT VERSION

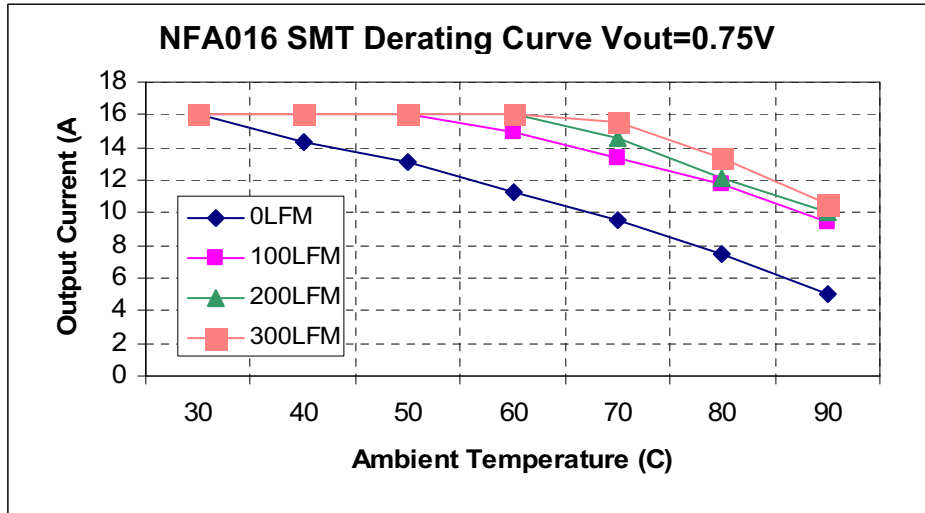

Fig. 2. SMT Power Derating vs Output Current for 12Vin 0.75V Out.

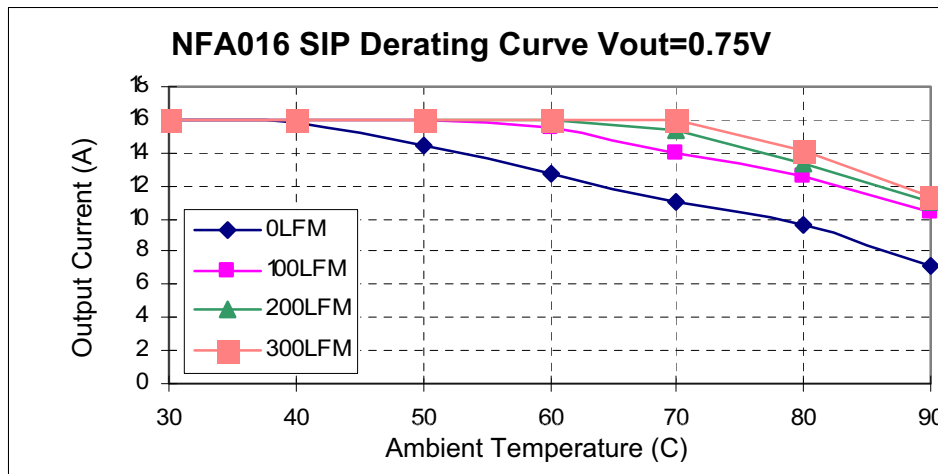

Fig. 3. SIP Power Derating vs Output Current for 12Vin 0.75V Out.

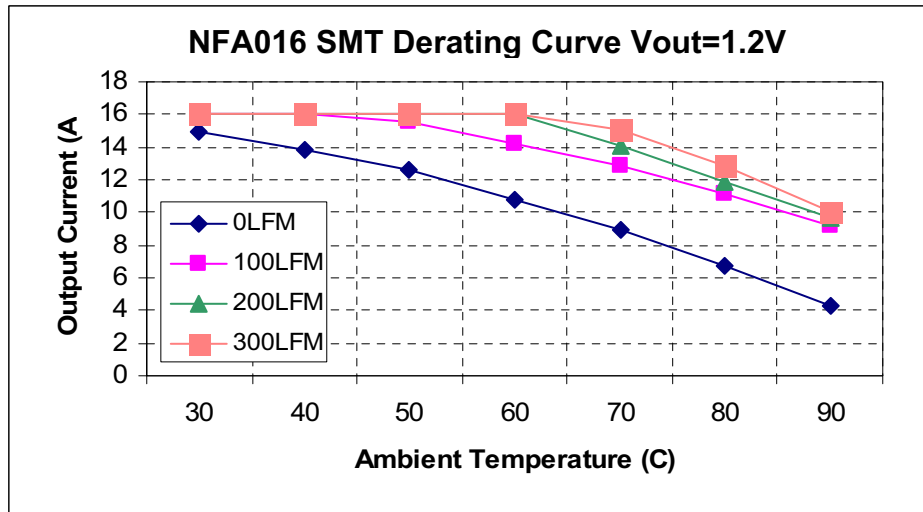

Fig 4. SMT Power Derating vs Output Current for 12Vin 1.2V Out.

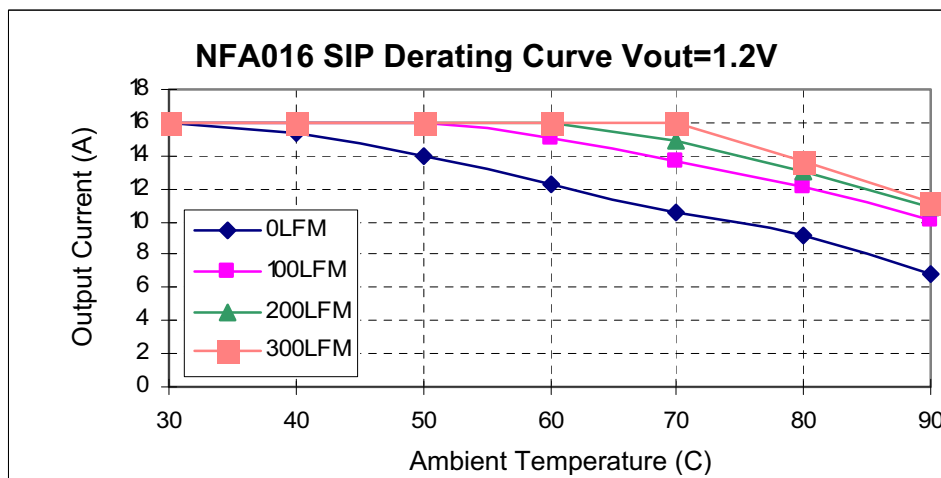

Fig 5. SIP Power Derating vs Output Current for 12Vin 1.2V Out.

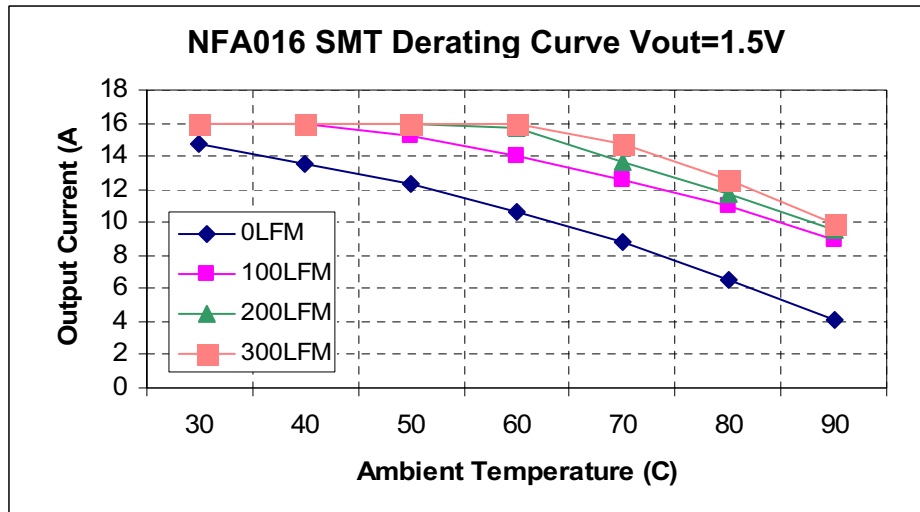

Fig 6. SMT Power Derating vs Output Current for 12Vin 1.5V Out.

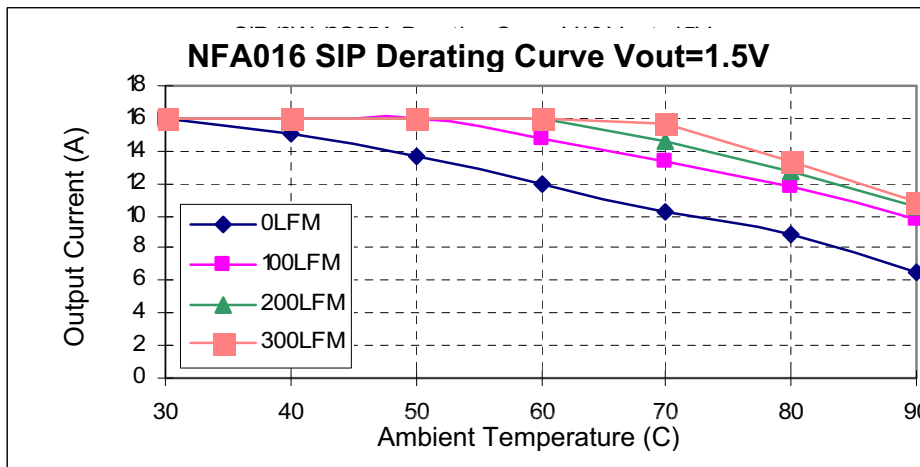

Fig 7. SIP Power Derating vs Output Current for 12Vin 1.5V Out.

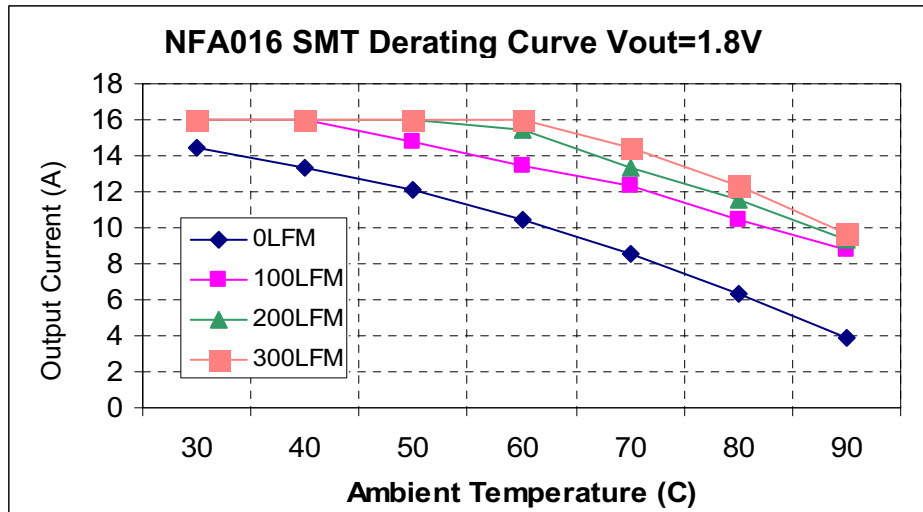

Fig 8. SMT Power Derating vs Output Current for 12Vin 1.8V Out.

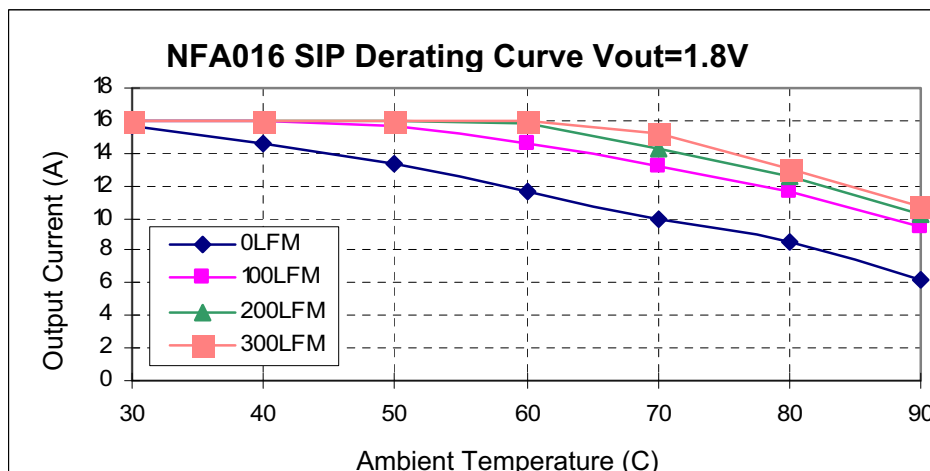

Fig 9. SIP Power Derating vs Output Current for 12Vin 1.8V Out.

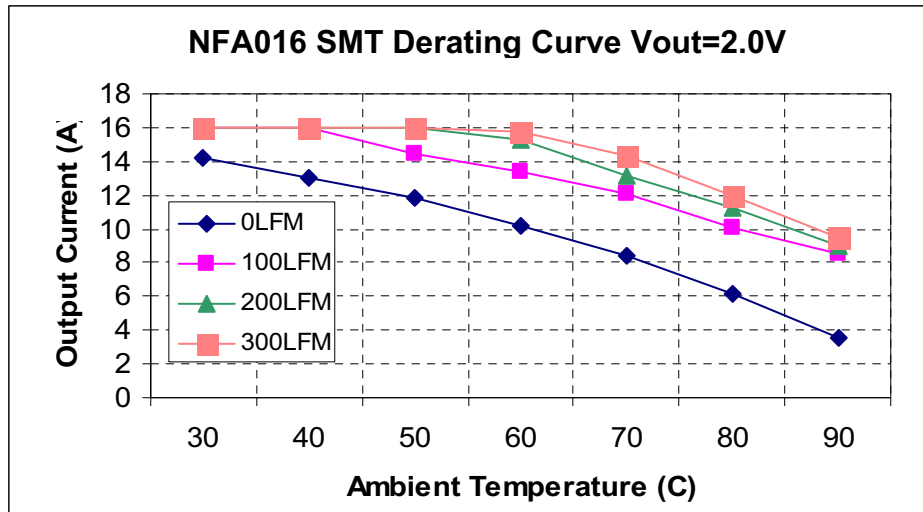

Fig 10. SMT Power Derating vs Output Current for 12Vin 2.0V Out.

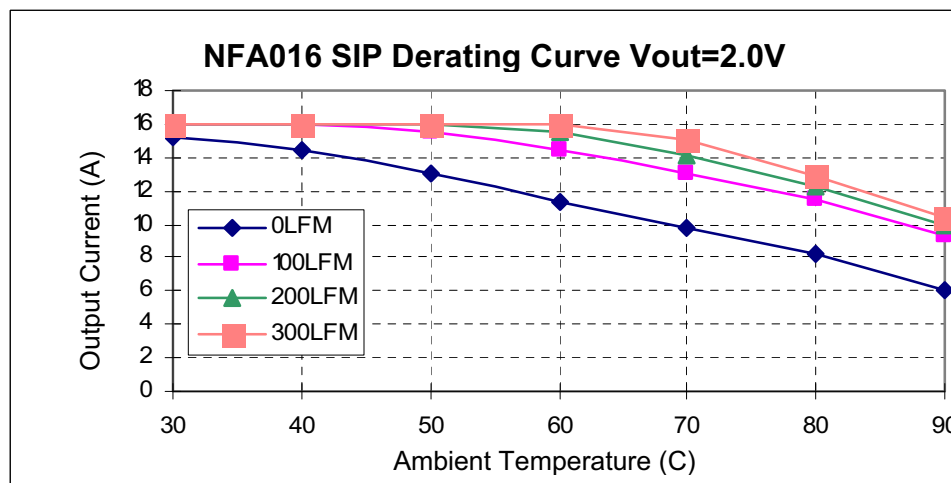

Fig 11. SIP Power Derating vs Output Current for 12Vin 2.0V Out.

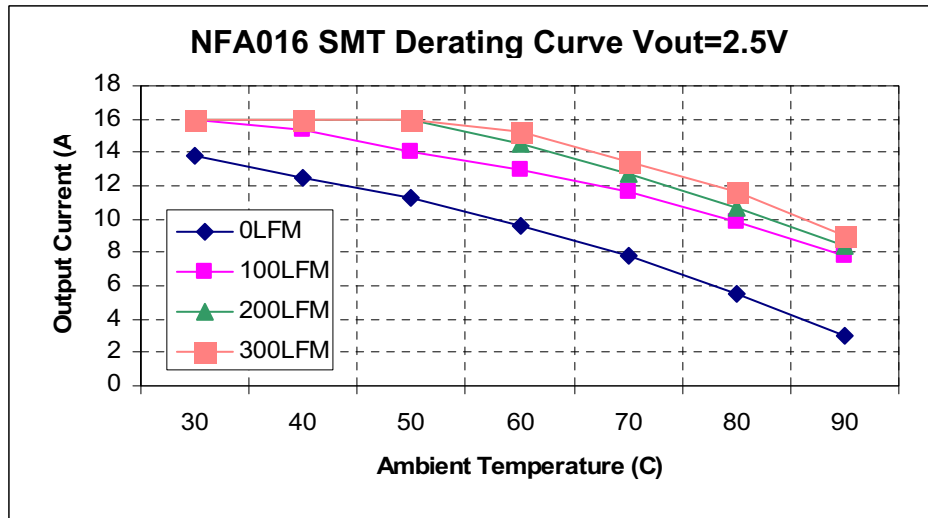

Fig 12. SMT Power Derating vs Output Current for 12Vin 2.5V Out.

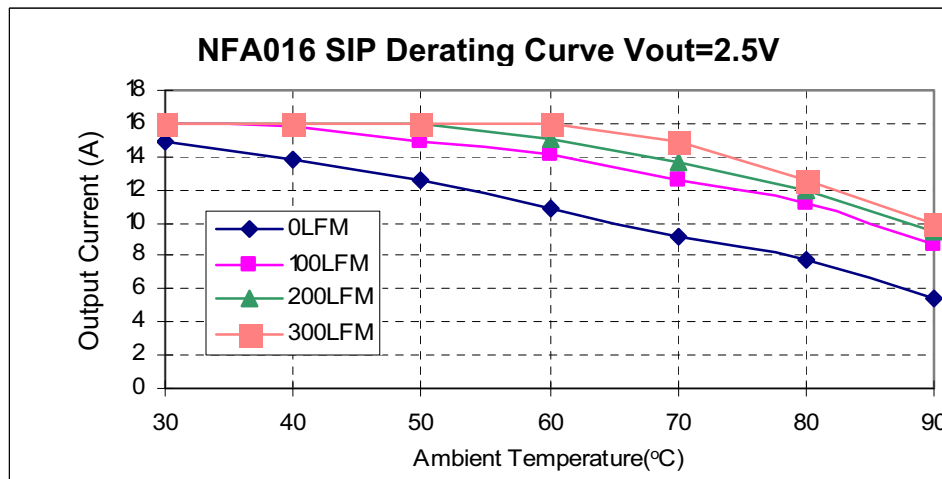

Fig 13. SIP Power Derating vs Output Current for 12Vin 2.5V Out.

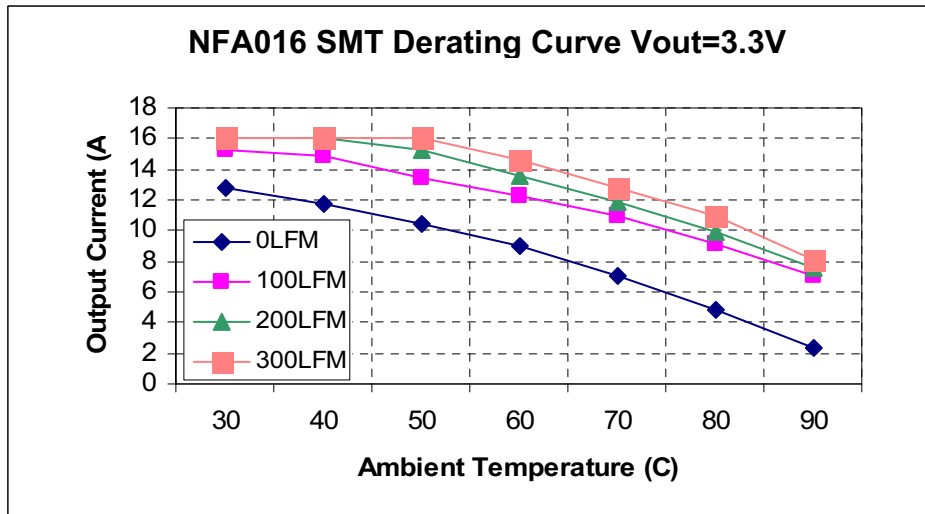

Fig. 14. SMT Power Derating vs Output Current for 12Vin 3.3V Out.

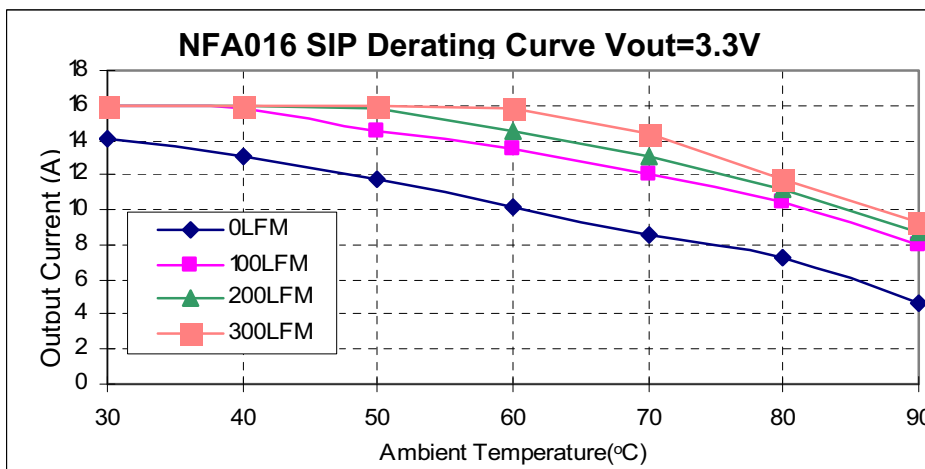

Fig. 15. SIP Power Derating vs Output Current for 12Vin 3.3V Out.

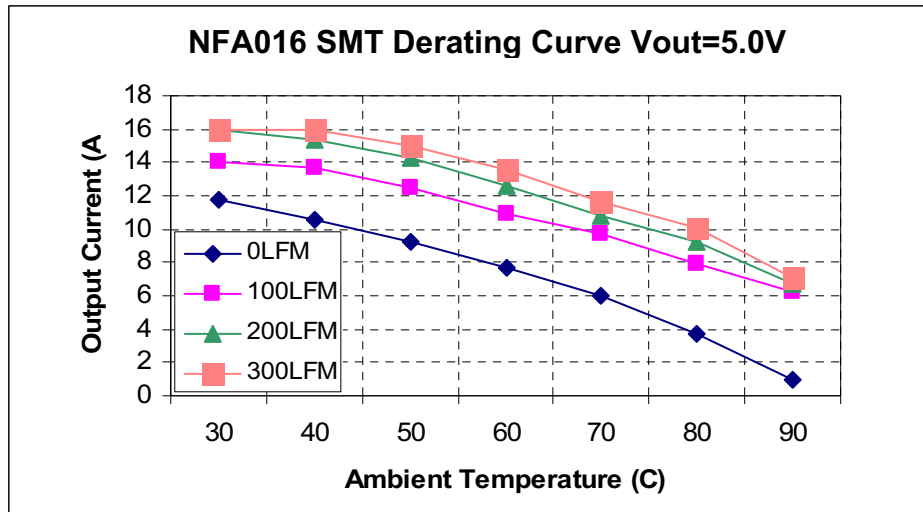

Fig. 16. SMT Power Derating vs Output Current for 12Vin 5.0V Out

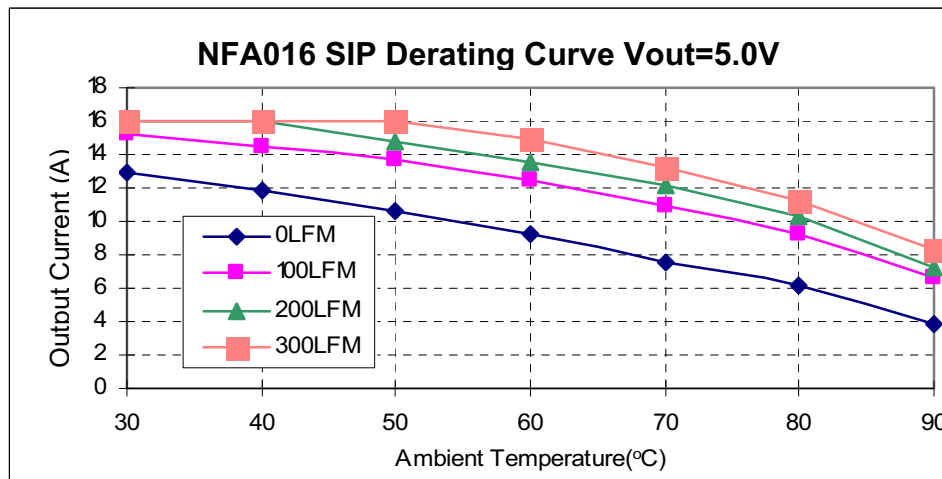

Fig 17. SIP Power Derating vs Output Current for 12Vin 5.0V Out.

TYPICAL EFFICIENCY CURVES FOR VARIOUS VOLTAGE MODELS SIP/SMT VERSION.

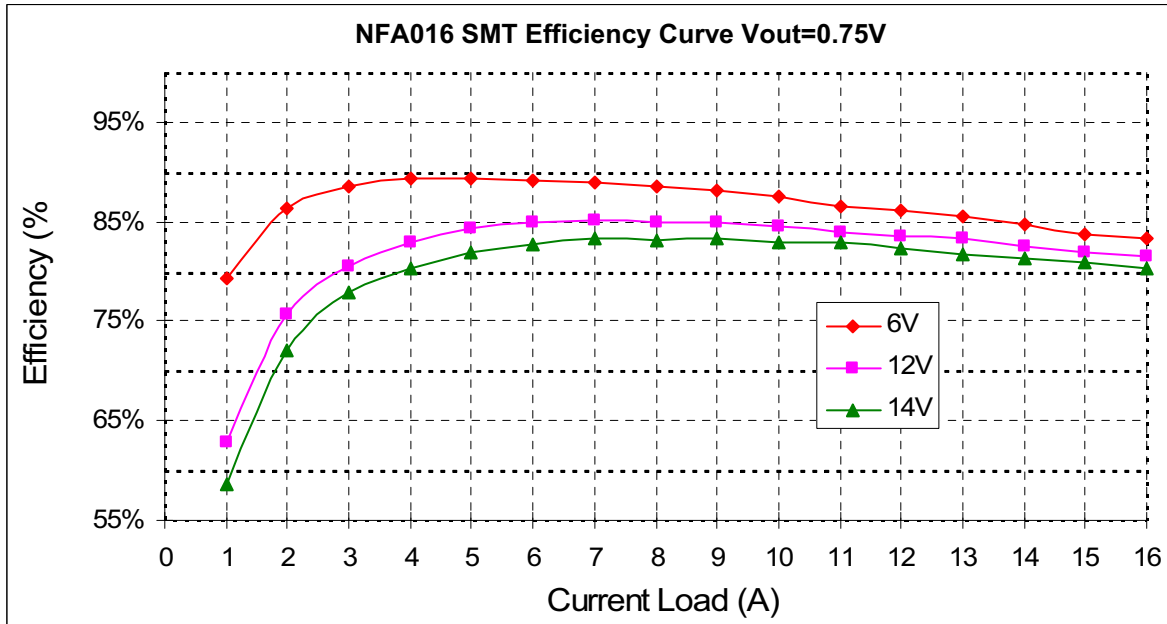

Fig 18. SMT Efficiency Curves for Vout=0.75V (25C)

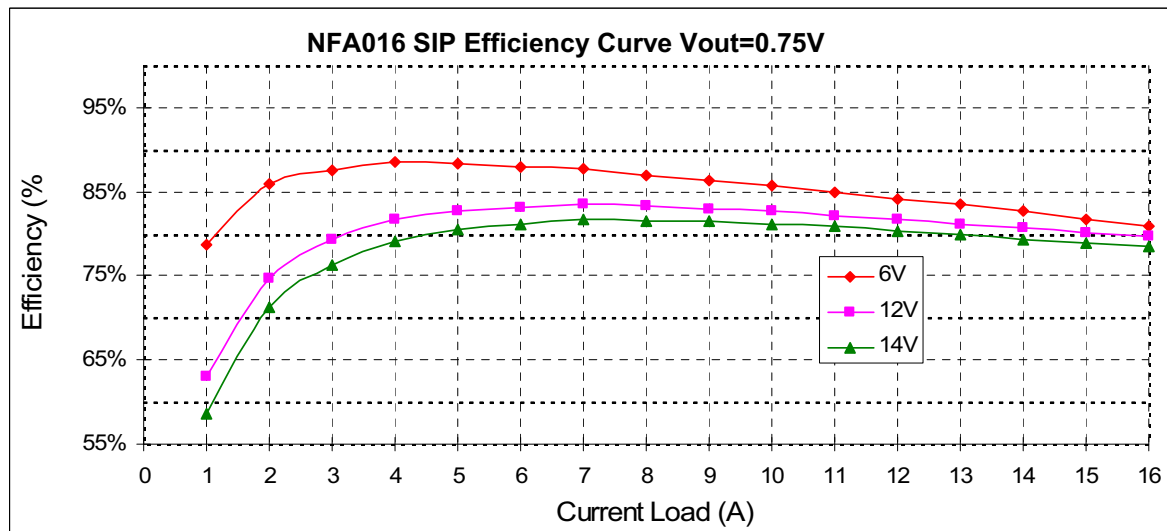

Fig 19. SIP Efficiency Curves for Vout=0.75V (25C)

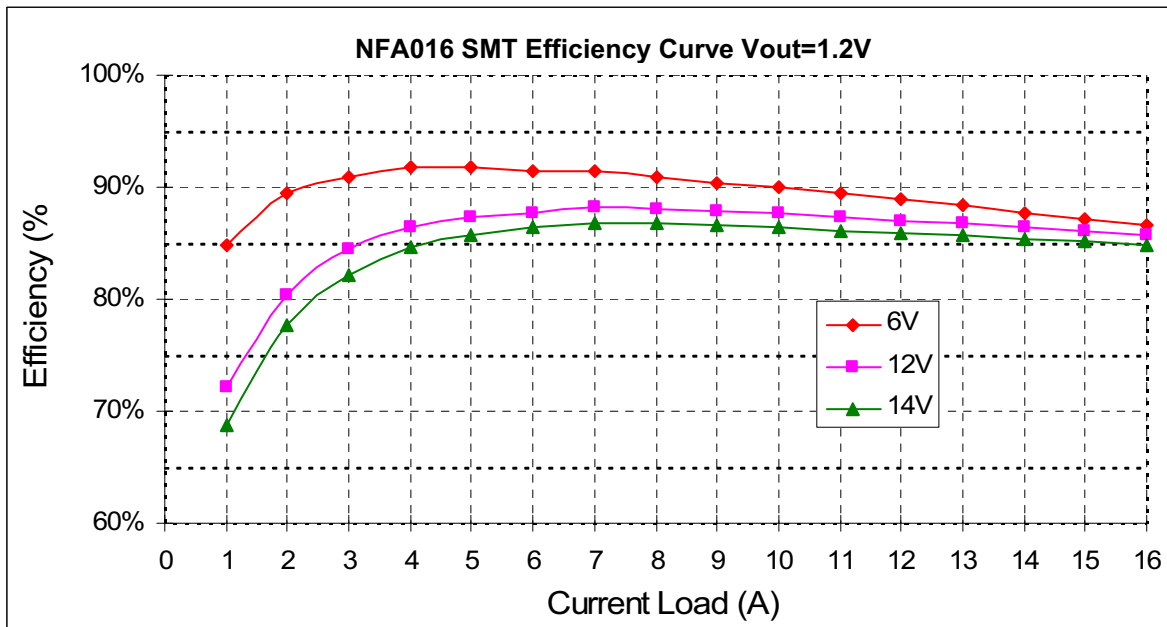

Fig 20. SMT Efficiency Curves for Vout=1.2V (25C)

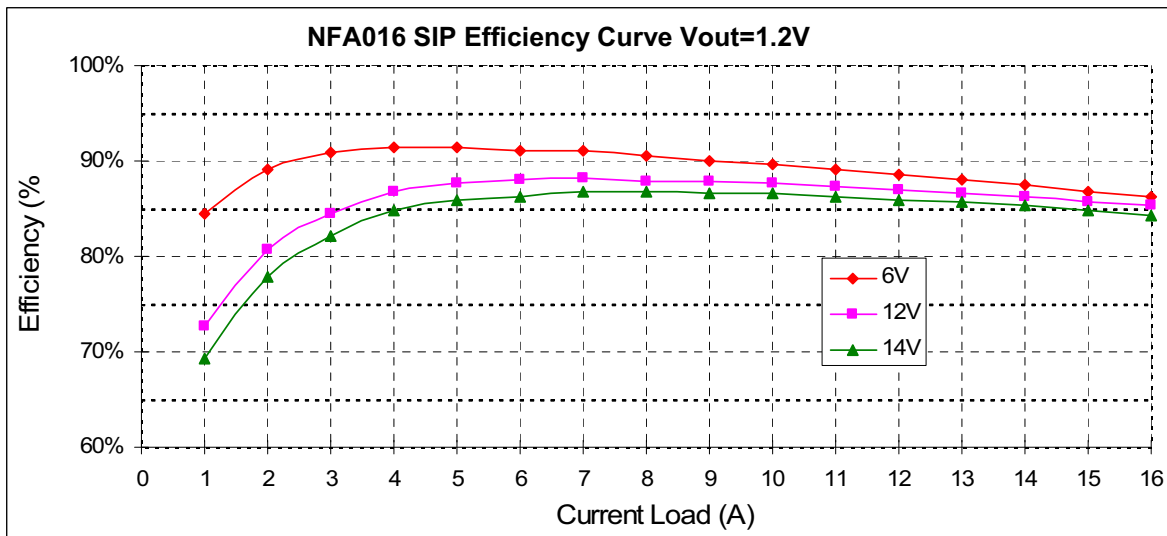

Fig 21. SIP Efficiency Curves for Vout=1.2V (25C)

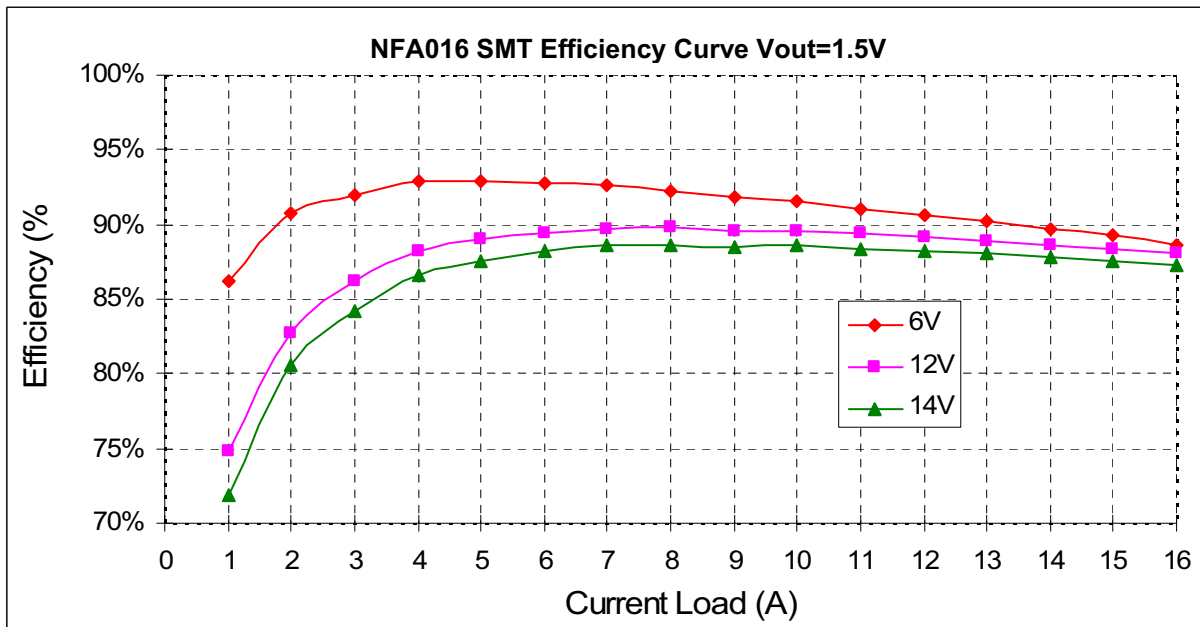

Fig 22. SMT Efficiency Curves for Vout=1.5V (25C)

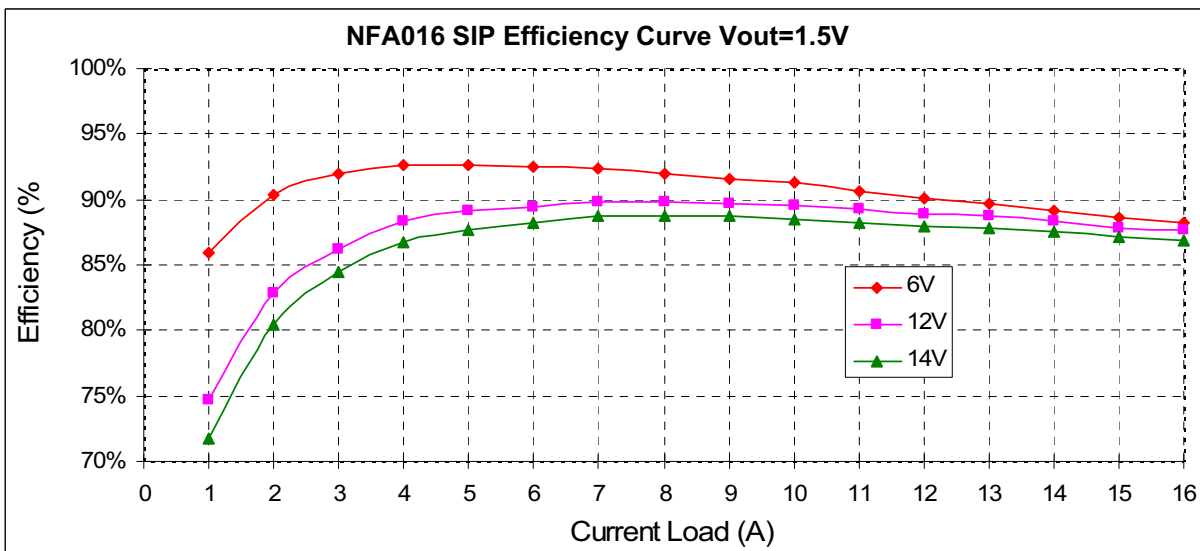

Fig 23. SIP Efficiency Curves for Vout=1.5V (25C)

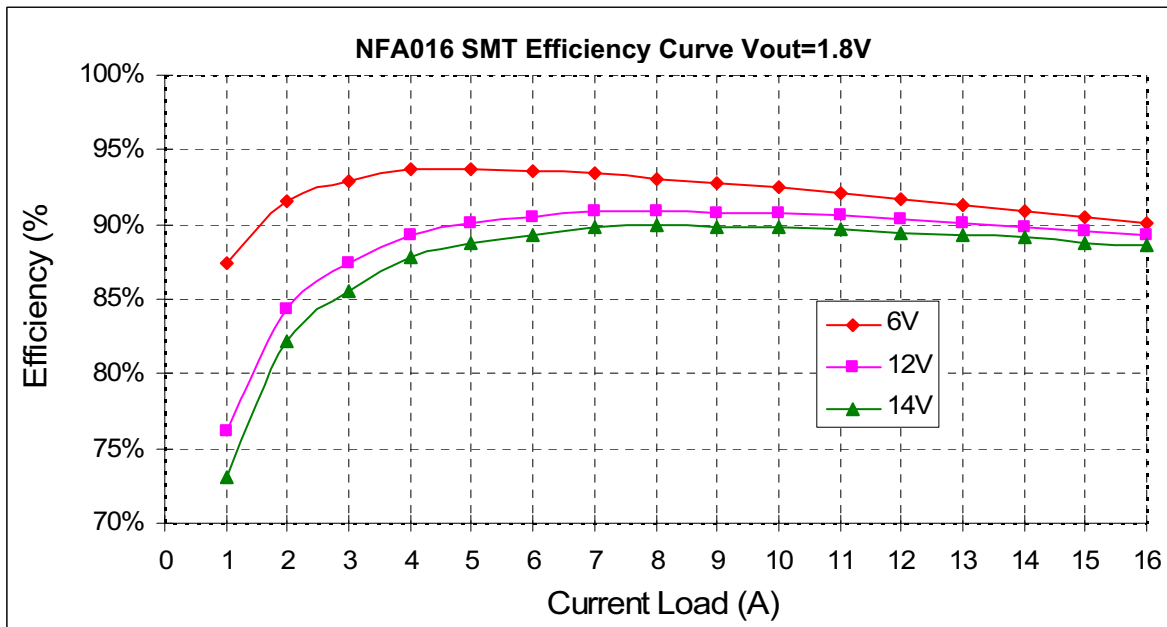

Fig 24. SMT Efficiency Curves for Vout=1.8V (25C)

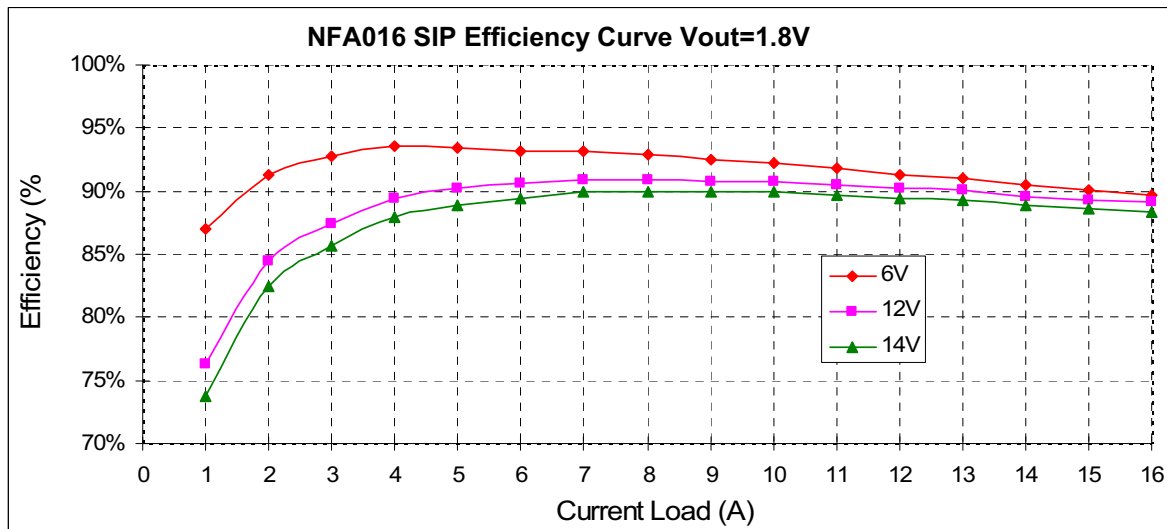

Fig 25. SIP Efficiency Curves for Vout=1.8V (25C)

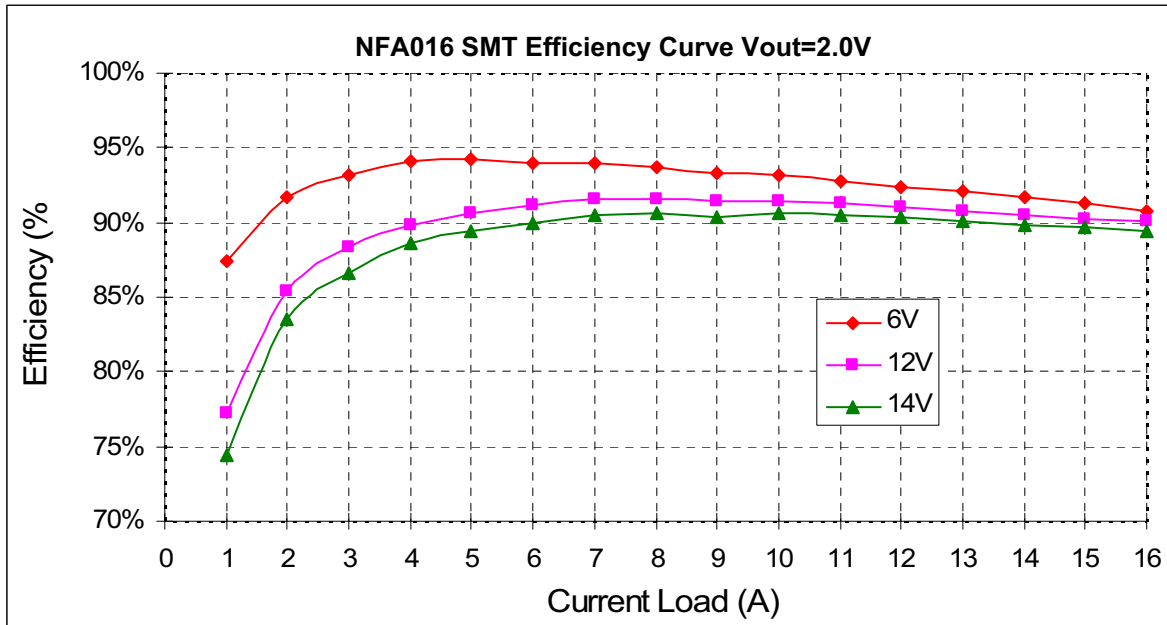

Fig 26. SMT Efficiency Curves for Vout=2.0V (25C)

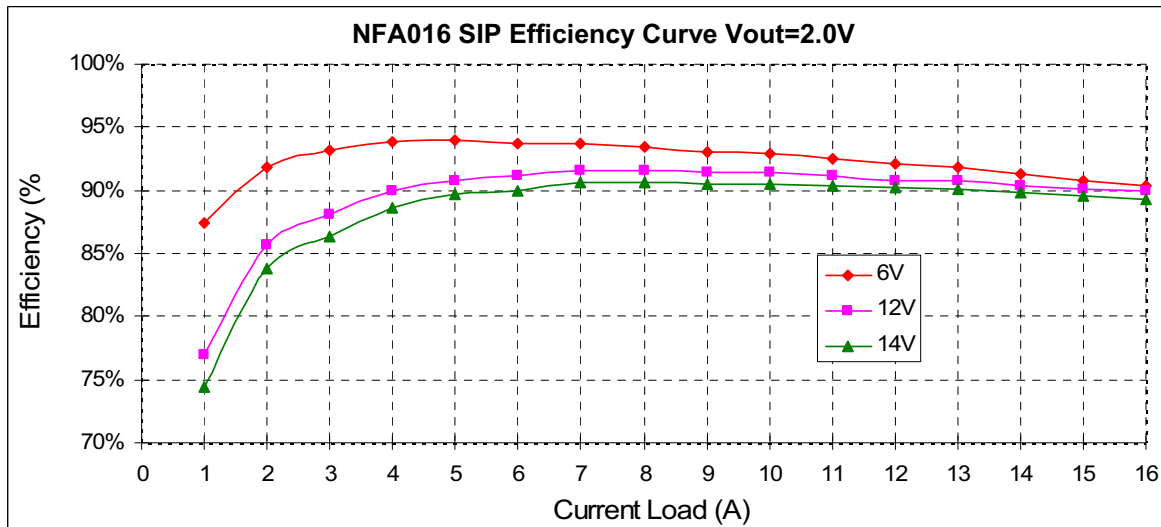

Fig 27. SIP Efficiency Curves for Vout=2.0V (25C)

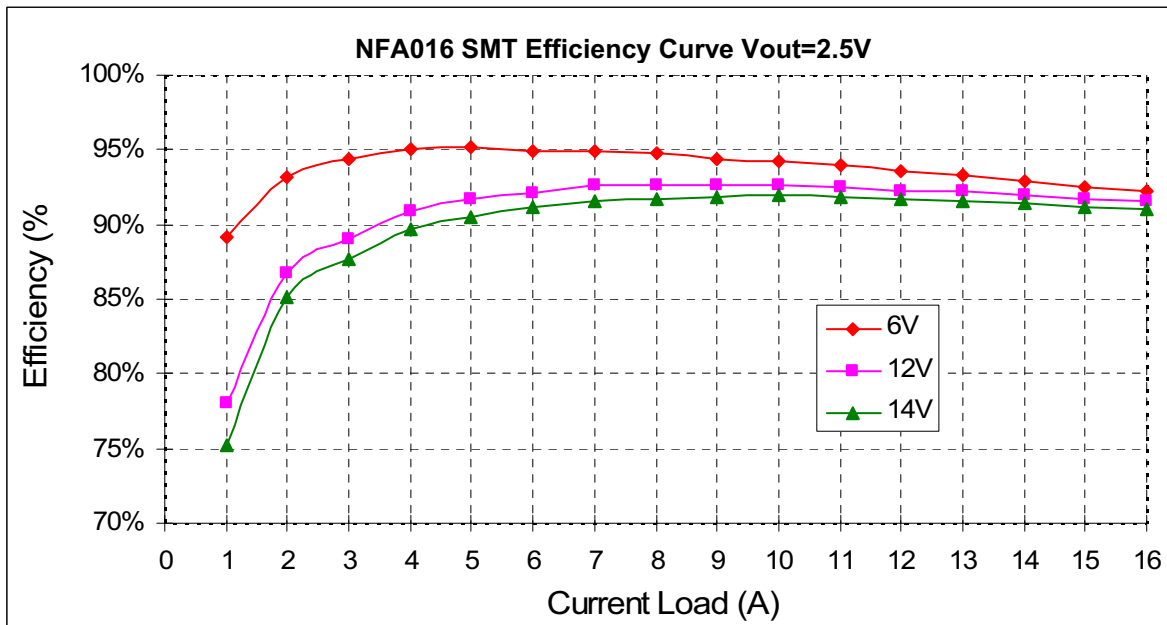

Fig 28. SMT Efficiency Curves for Vout=2.5V (25C)

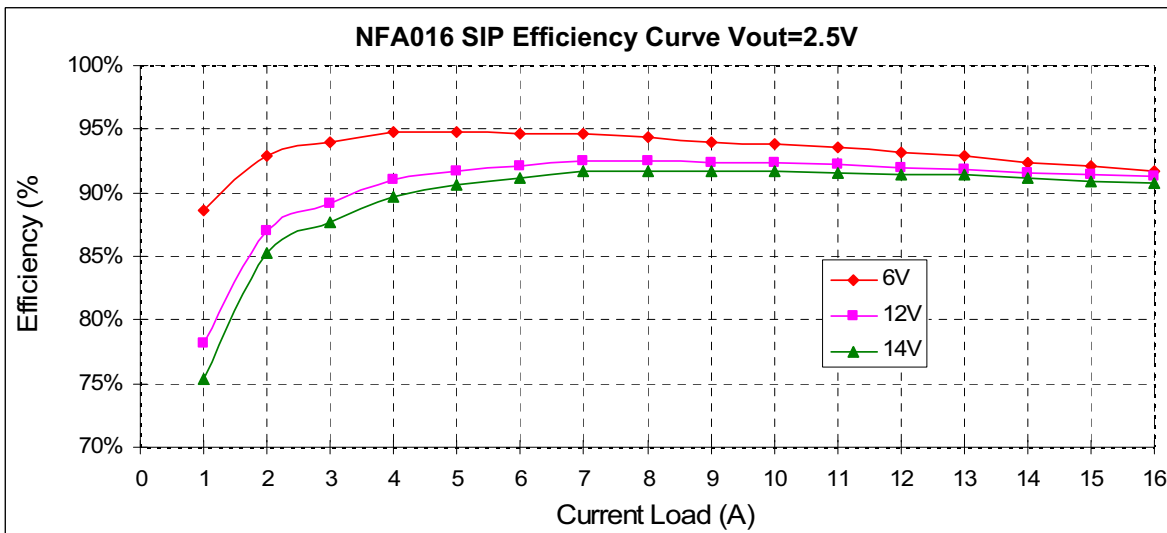

Fig 29. SIP Efficiency Curves for Vout=2.5V (25C)

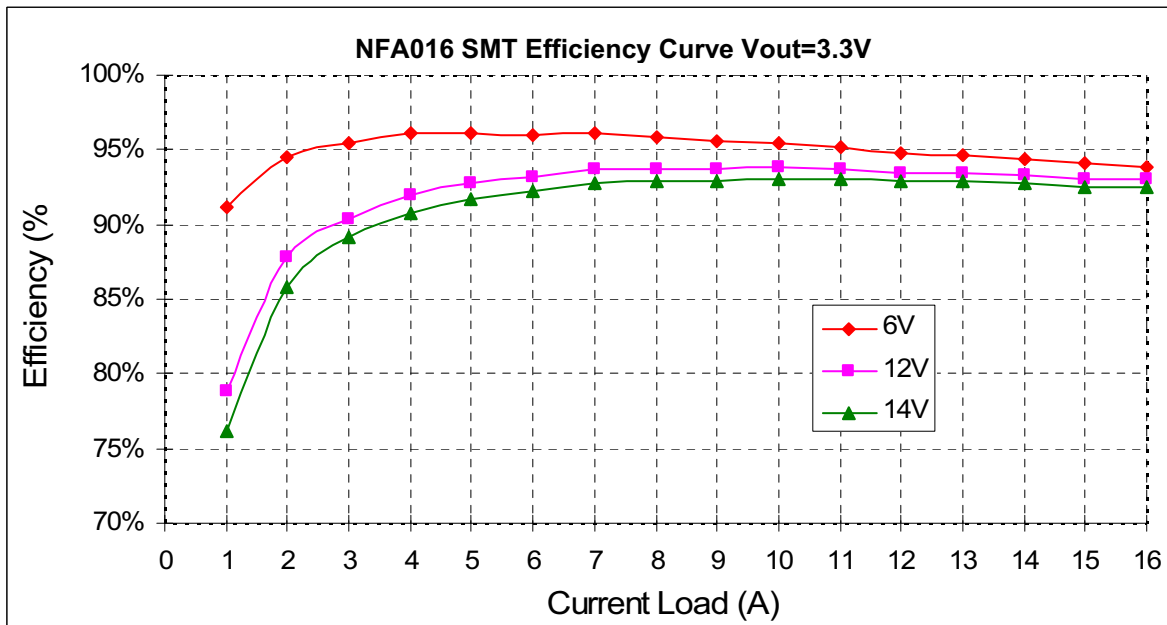

Fig 30. SMT Efficiency Curves for Vout=3.3V (25C)

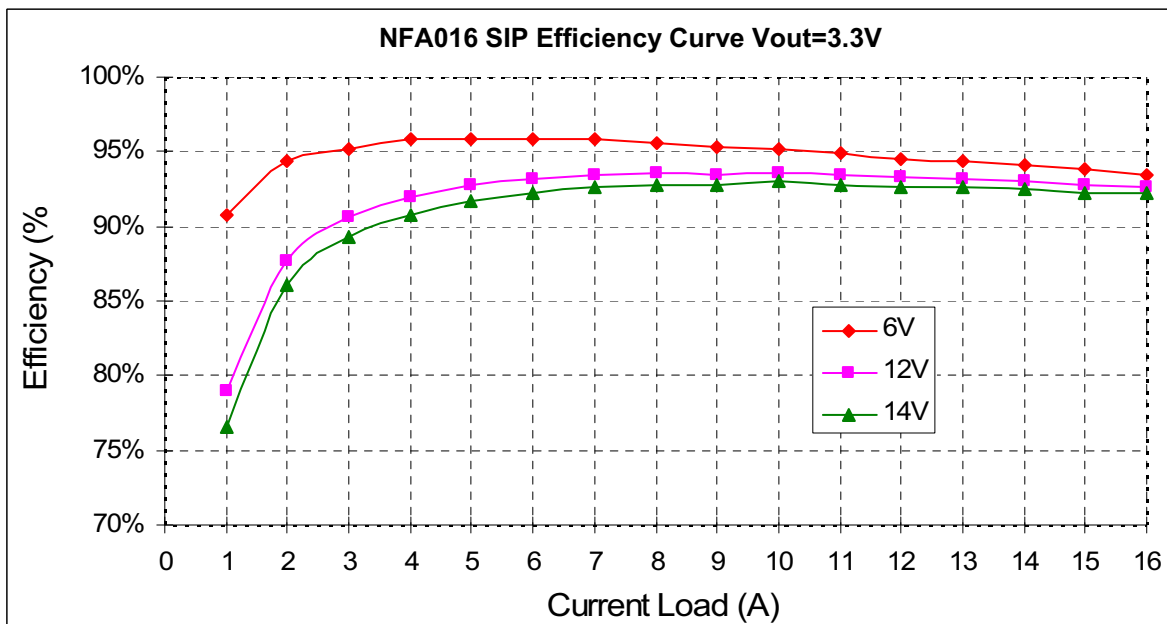

Fig 31. SIP Efficiency Curves for Vout=3.3V (25C)

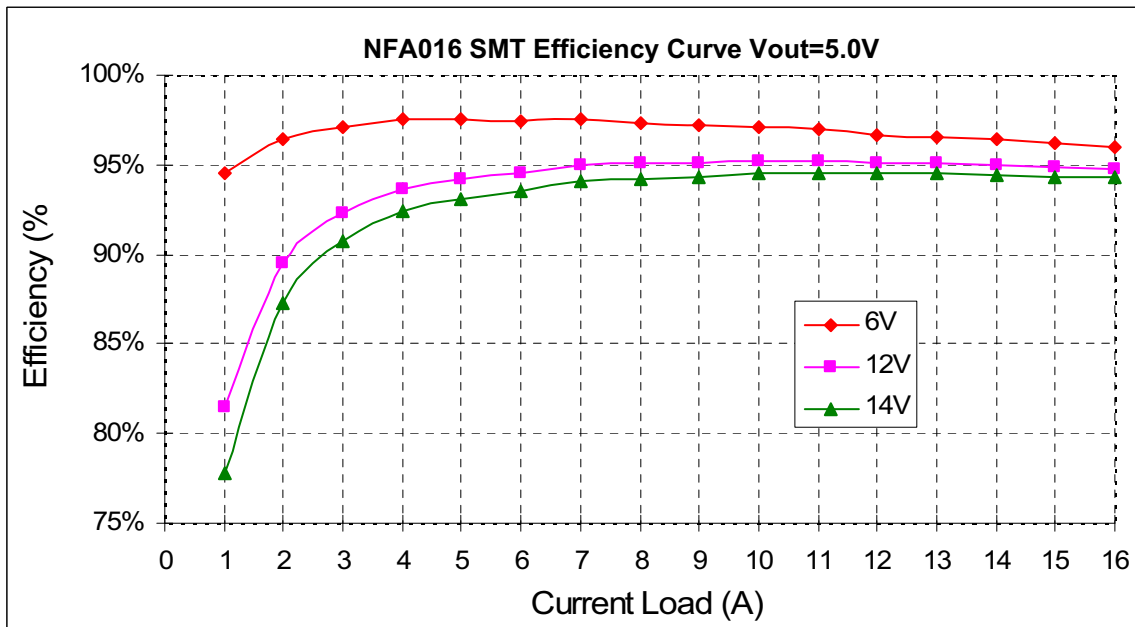

Fig 32. SMT Efficiency Curves for Vout=5.0V (25C)

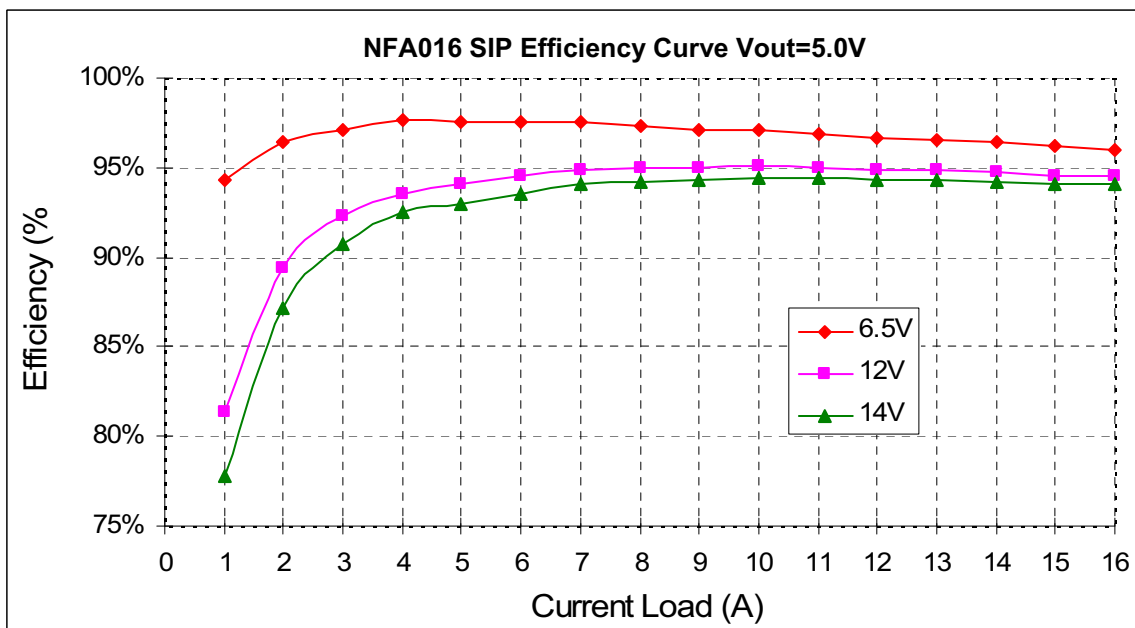
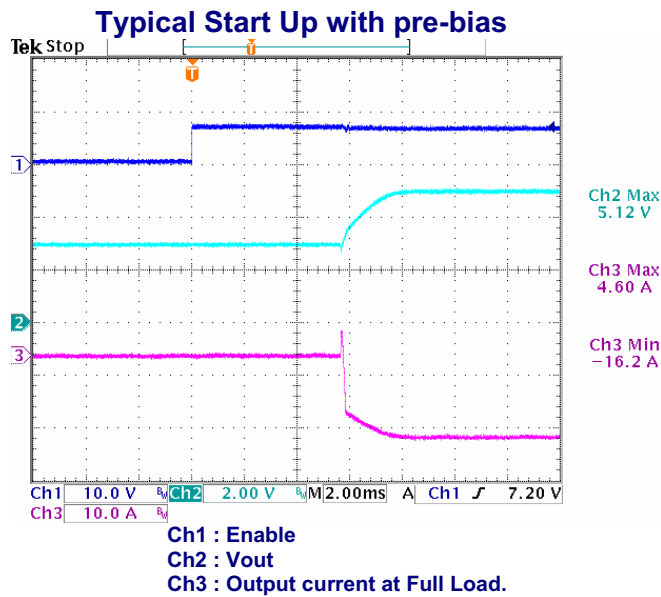
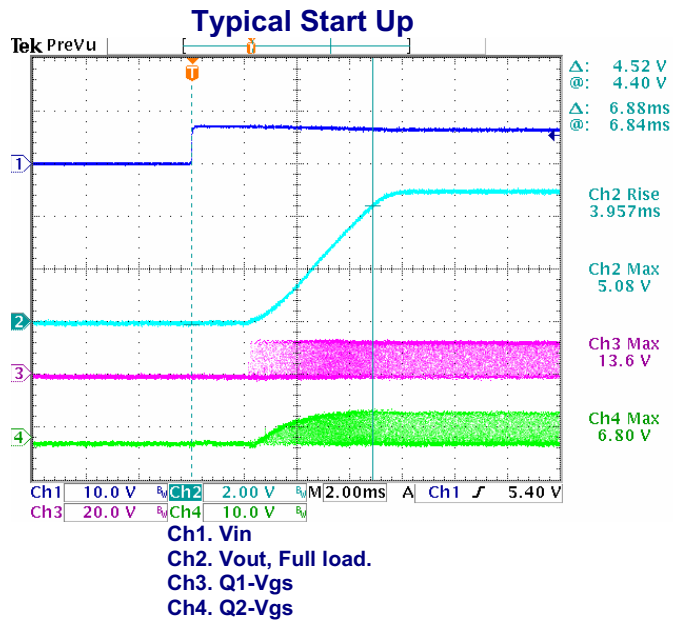
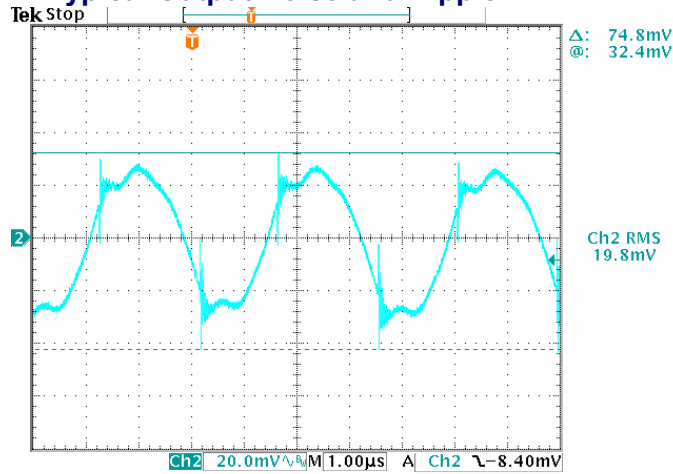

Fig 33. SIP Efficiency Curves for Vout=5.0V (25C)



Typical Output Noise and Ripple



Vin = 12Vdc , Vo=5.0V/16A
 Output with 1uF ceramic and 10uF tantalum capacitor

Typical Output Transient Response

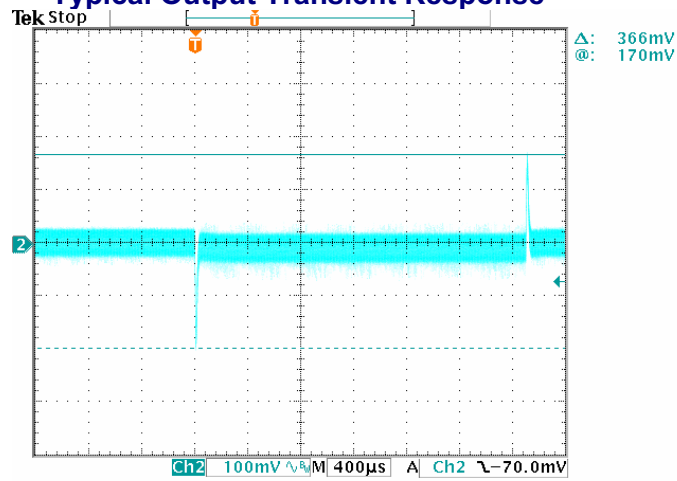

Vin = 12Vdc , Vo=5.0V , 50% - 100% - 50% Load change , @2.5A/uS

Output Voltage Set point adjustment.

NFA Series can also be programmed by applying a voltage between the TRIM and GND pins (Figure below). The following equation can be used to determine the value of V_{trim} needed to obtain a desired output voltage V_o :

$$V_{trim} = (0.7 - 0.0667 \times \{V_o - 0.7525\})$$

For example, to program the output voltage of NFA Series module to 3.3 Vdc, V_{trim} is calculated as follows:

$$V_{trim} = (0.7 - 0.0667 \times \{3.3 - 0.7525\})$$

$$V_{trim} = 0.530V$$

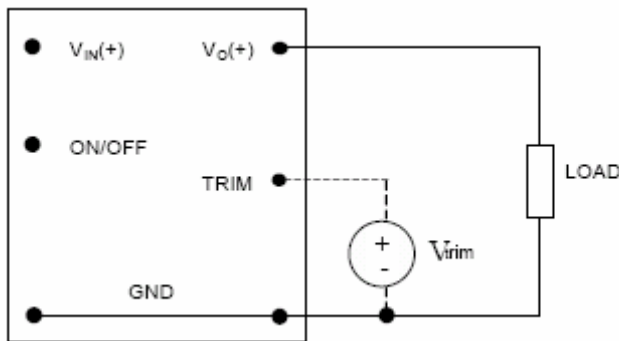

Circuit Configuration for programming Output voltage using external voltage source

Table 1 provides R_{trim} values for some common output voltages, while Table 2 provides values of the external voltage source, V_{trim} for the same common output voltages.

Table 1

$V_{O, set} (V)$	$R_{trim} (K\Omega)$
0.7525	Open
1.2	22.46
1.5	13.05
1.8	9.024
2.5	5.009
3.3	3.122

Table 2

$V_{O, set} (V)$	$V_{trim} (V)$
0.7525	Open
1.2	0.670
1.5	0.650
1.8	0.630
2.5	0.583
3.3	0.530
5	0.417

$$R_{adj} = \left(\frac{15 \times 0.7}{V_o - 0.7525} \right) - 1 \text{ (K}\Omega\text{)}$$

By using a 1% tolerance trim resistor, set point tolerance of $\pm 2\%$ is achieved as specified in the electrical specification.

Remote Sense:

All Celestica SMT/SIP power modules offer an option for remote sense. The remote sense compensates for any distribution drops to accurately control voltage at the point of load. The voltage between the sense pin to Vout pin should not exceed 0.5V.

Voltage Sequencing:

NFA series power modules offer the ability to precisely sequence output voltage rise. The sequence feature limits the output voltage to that presented at the Sequence pin. For example, if the sequence pin is connected to a variable voltage source, and the converter is enabled, output voltage will track the voltage applied to the sequence pin, to a maximum of the programmed output voltage. If this feature is not required, the sequence pin should remain unconnected. In practice, the Sequence pin of a lower voltage converter may be connected to a higher voltage source to ensure the lower voltage does not exceed the higher voltage during power on and power off. If multiple NFA series converters are used, all Sequence pins may be connected to the same higher voltage. In this way, all voltage rails will rise at the same rate, and cease to rise at their respective programmed output voltages.

SMT Lead free Reflow profile

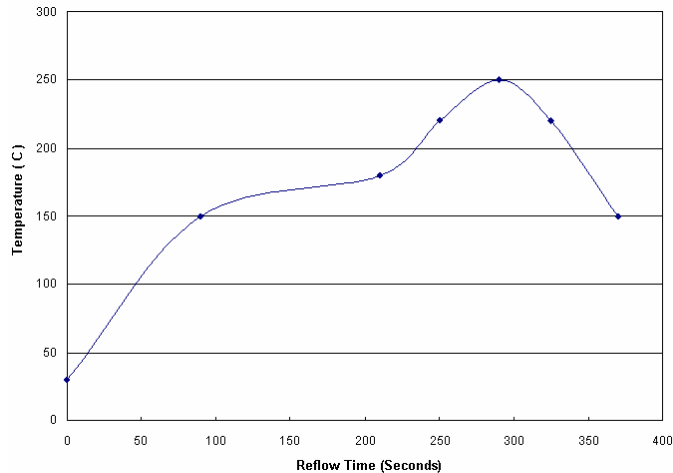

1. Ramp up rate during preheat : 1.33 °C/Sec (From 30°C to 150°C)
2. Soaking temperature : 0.29 °C/Sec (From 150°C to 180°C)
3. Ramp up rate during reflow : 0.8 °C/Sec (From 220°C to 250°C)
4. Peak temperature : 250°C, above 220°C 40 to 70 Seconds
5. Ramp up rate during cooling : -1.56 °C/Sec (From 220°C to 150°C)

Mechanical and pinning Information.

Given below is the outline drawing showing physical dimensions of the SIP & SMT package.

The external dimensions for SMT package are 33.00mm X 13.46mm X 9.3mm.

BOTTOM VIEW OF BOARD

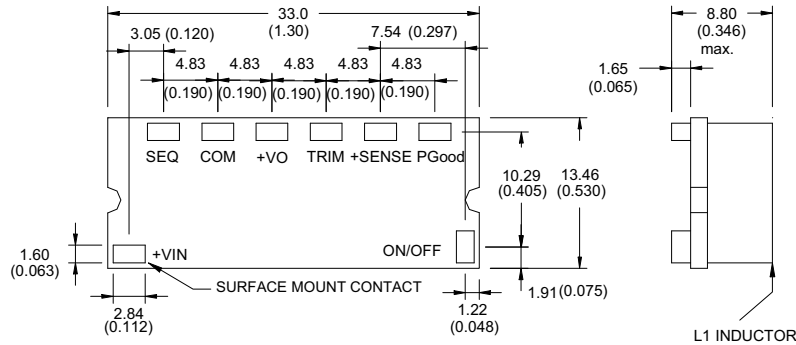

Dimensions are in millimeters(Inches)
Tolerances :X.X = ±0.5mm(0.02in), X.XX = ±0.25mm(0.010in), unless otherwise noted.

Recommended Pad Layout

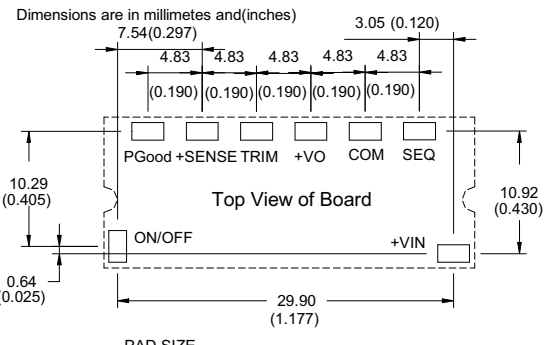

PAD SIZE
MIN:3.556x2.413(0.140x0.095)
MAX:4.19x2.79(0.165x0.110)

Whereas, the external dimensions of the SIP version are 50.8mm X 12.95mm X 8.30mm.

SIZE SIP

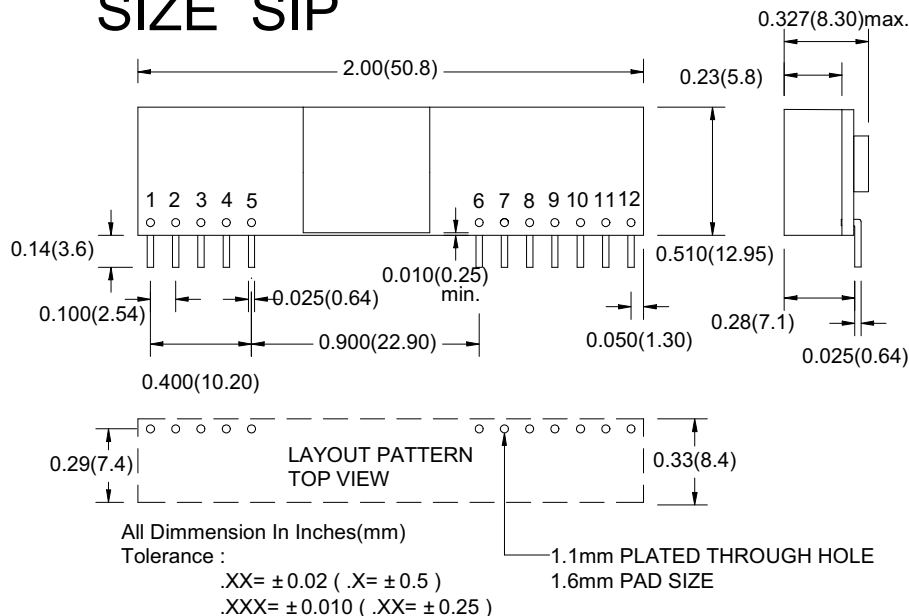

PIN CONNECTION	
Pin	FUNCTION
1	+Output
2	+Output
3	+Sense
4	+Output
5	Common
6	PGood
7	Common
8	+V Input
9	+V Input
10	Sequence
11	Trim
12	On/Off Control

Safety Considerations

The NFA series of converters are certified to IEC/EN/CSA/UL 60950. If this product is built into information technology equipment, the installation must comply with the above standard. An external input fuse (no more 20 A recommended) must be used to meet the above requirements. The output of the converter [Vo(+)/Vo(-)] is considered to remain within SELV limits when the input to the converter meets SELV or TNV-2 requirements. The converters and materials meet UL 94V-0 flammability ratings.

Ordering Information

Part Number	Vin*	Vout	Iout	Enable Logic	Pin Length
NFA0161500B0C	6.0V - 14.0V	0.75V – 5.0V	16A	Negative	0.139"
NFA0161500S0C	6.0V - 14.0V	0.75V – 5.0V	16A	Negative	SMT
NFA0161501B0C	6.0V - 14.0V	0.75V – 5.0V	16A	Positive	0.139"
NFA0161501S0C	6.0V - 14.0V	0.75V – 5.0V	16A	Positive	SMT



* An input voltage of 6.5 Volts is required for 5 Volt output at full load.

Label Information

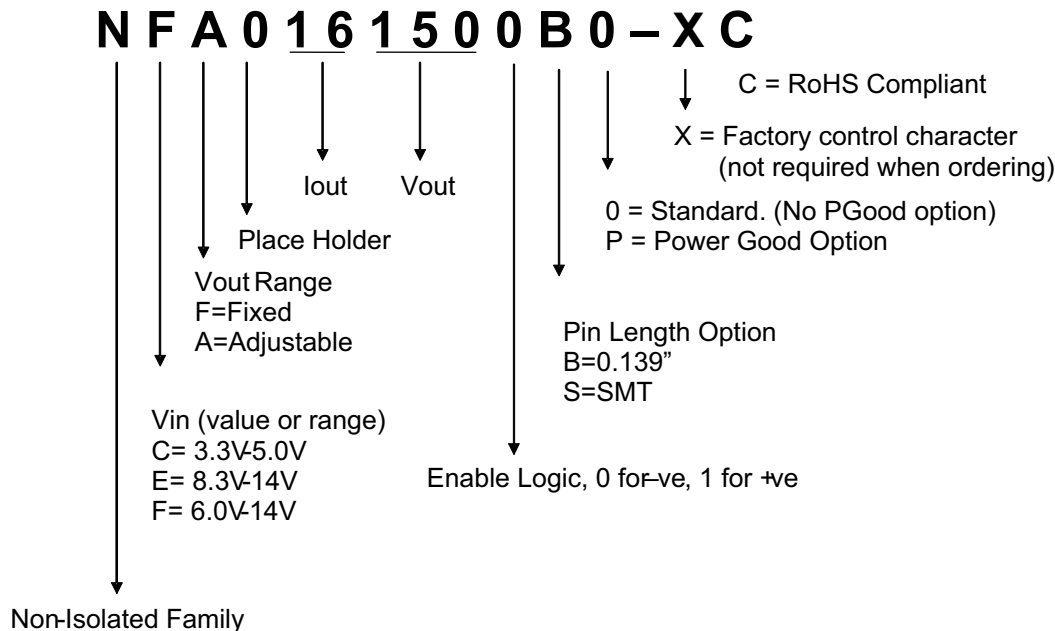

RoHS Compliant

The NFA016 series of converters is in compliance with the European Union Directive 2002/95/EC (RoHS) with respect to the following substances: lead (Pb), mercury (Hg), cadmium (Cd), hexavalent chromium, polybrominated biphenyls (PBB) or polybrominated diphenyl ethers (PBDE).

Murata Power Solutions, Inc.
 11 Cabot Boulevard, Mansfield, MA 02048-1151 U.S.A.
 Tel: (508) 339-3000 (800) 233-2765 Fax: (508) 339-6356
 www.murata-ps.com email: sales@murata-ps.com ISO 9001 REGISTERED

Murata Power Solutions, Inc. makes no representation that the use of its products in the circuits described herein, or the use of other technical information contained herein, will not infringe upon existing or future patent rights. The descriptions contained herein do not imply the granting of licenses to make, use, or sell equipment constructed in accordance therewith. Specifications are subject to change without notice.
 © 2008 Murata Power Solutions, Inc.

UK: Milton Keynes, Tel: +44 (0)1908 615232, email: mk@murata-ps.com
France: Montigny Le Bretonneux, Tel: +33 (0)1 34 60 01 01, email: france@murata-ps.com
Germany: München, Tel: +49 (0)89-544334-0, email: munich@murata-ps.com
Japan: Tokyo, Tel: 3-3779-1031, email: sales_tokyo@murata-ps.com
 Osaka, Tel: 6-6354-2025, email: sales_osaka@murata-ps.com
Website: www.murata-ps.jp
China: Shanghai, Tel: +86 215 027 3678, email: shanghai@murata-ps.com
 Guangzhou, Tel: +86 208 221 8066, email: guangzhou@murata-ps.com