



# S-5813A/14A/15A/16A Series

[www.sii-ic.com](http://www.sii-ic.com)

## CMOS TEMPERATURE SENSOR IC

© Seiko Instruments Inc., 2006-2010

Rev.3.0\_00

The S-5813A/14A/15A/16A Series is a family of high-precision temperature sensor ICs on a single chip with a linear output voltage for temperature changes.

Each chip is composed of a temperature sensor, a constant current circuit, and an operational amplifier.

The operating ambient temperature is from  $-40^{\circ}\text{C}$  to  $+100^{\circ}\text{C}$ . These devices have much better linearity than other temperature sensors such as thermistors, and can be used for a wide range of temperature control applications.

### ■ Features

- Temperature accuracy  
S-5813A/15A Series :  $\pm 5.0^{\circ}\text{C}$  ( $-30^{\circ}\text{C}$  to  $+100^{\circ}\text{C}$ )  
S-5814A/16A Series :  $\pm 2.5^{\circ}\text{C}$  ( $-30^{\circ}\text{C}$  to  $+100^{\circ}\text{C}$ )
- Linear output voltage  
 $-11.04\text{ mV}/^{\circ}\text{C}$  typ.  
Ta =  $-30^{\circ}\text{C}$  : 2.582 V typ.  
Ta =  $+30^{\circ}\text{C}$  : 1.940 V typ.  
Ta =  $+100^{\circ}\text{C}$  : 1.145 V typ.
- Nonlinearity  
 $\pm 0.5\%$  typ. ( $-20^{\circ}\text{C}$  to  $+80^{\circ}\text{C}$ )
- Wide power supply voltage operation  
V<sub>DD</sub> = 2.4 V to 10.0 V ( $+25^{\circ}\text{C}$ )
- Low current consumption  
4.0  $\mu\text{A}$  typ. ( $+25^{\circ}\text{C}$ )
- Built-in operational amplifier
- Output voltage referred to V<sub>SS</sub>
- Lead-free, Sn 100%, halogen-free\*1

\*1. Refer to "■ Product Name Structure" for details.

### ■ Applications

- Compensation of high-frequency circuits such as cellular phones and radio equipment
- Compensation of oscillation frequency in crystal oscillator
- LCD contrast compensation
- Compensation of amplifier gain
- Compensation of auto focus circuits
- Temperature detection in battery management
- Overheating prevention for charged batteries or halogen lights

### ■ Packages

- SNT-4A
- WLP-4B

■ Block Diagram

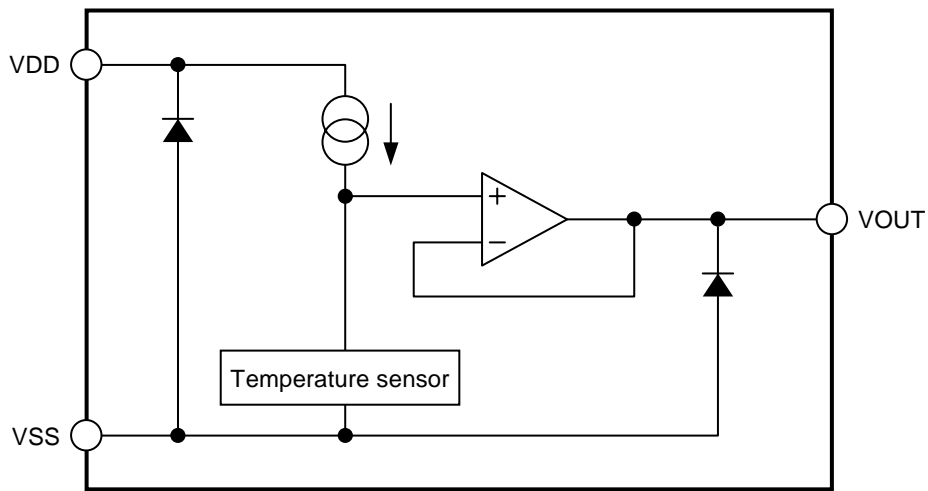

Figure 1

■ **Product Name Structure**

- The product types for the S-5813A/14A/15A/16A Series can be selected at the user's request. Please refer to the followings regarding the construction of the product name and the full product name.

S-5813A/14A Series : "1.1 Product name", "1.2 Package", "1.3 Product name list"  
 S-5815A/16A Series : "2.1 Product name", "2.2 Package", "2.3 Product name list"

**1. S-5813A/14A Series**

**1.1 Product name**

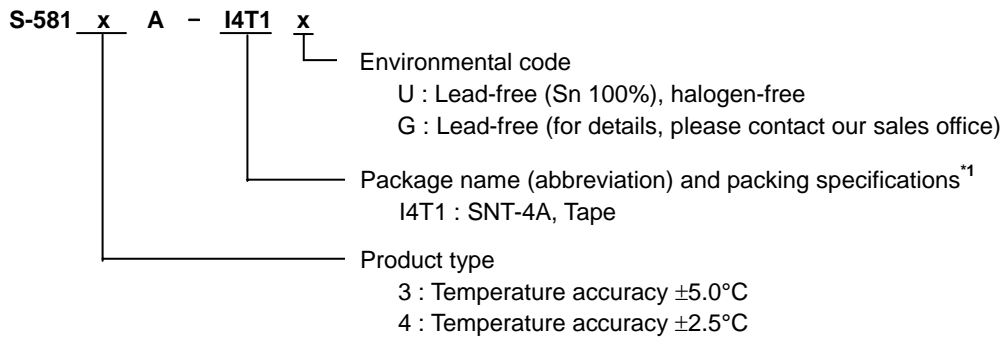

\*1. Refer to the tape specifications at the end of this book.

**1.2 Package**

Package Name	Drawing Code			
	Package	Tape	Reel	Land
SNT-4A	PF004-A-P-SD	PF004-A-C-SD	PF004-A-R-SD	PF004-A-L-SD

**1.3 Product name list**

**Table 1**

Product Name	Temperature Accuracy	Package
S-5813A-I4T1x	±5.0°C	SNT-4A
S-5814A-I4T1x	±2.5°C	SNT-4A

- Remark1.** x: G or U  
 2. Please select products of environmental code = U for Sn 100%, halogen-free products.

**2. S-5815A/16A Series**

**2.1 Product name**

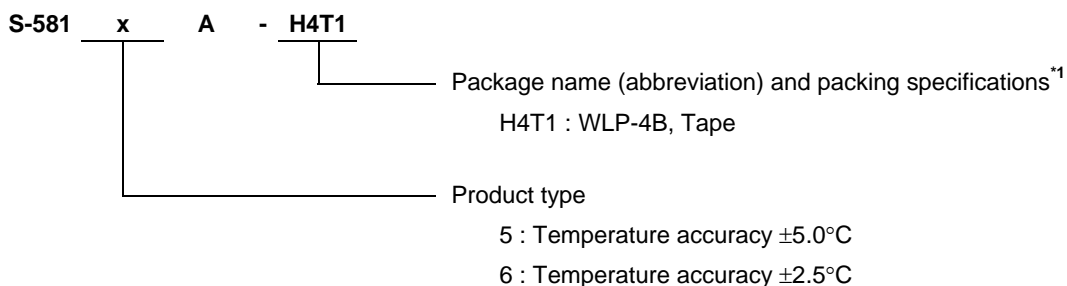

\*1. Refer to the tape specifications at the end of this book.

**2.2 Package**

Package Name	Drawing Code		
	Package	Tape	Reel
WLP-4B	HB004-B-P-SD	HB004-B-C-SD	HB004-B-R-SD

**2.3 Product name list**

**Table 2**

Product Name	Temperature Accuracy	Package
S-5815A-H4T1	$\pm 5.0^{\circ}\text{C}$	WLP-4B
S-5816A-H4T1	$\pm 2.5^{\circ}\text{C}$	WLP-4B

■ **Pin Configurations**

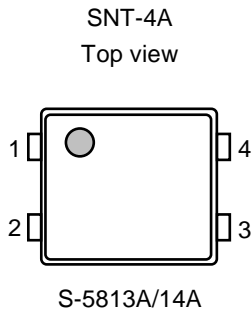

**Figure 2**

**Table 3**

(S-5813A/14A Series)

Pin No.	Pin Name	Pin Description
1	VSS	GND pin
2	VDD	Power supply pin
3	VOUT	Output voltage pin
4	NC <sup>*1</sup>	No connection

\*1. The NC pin is electrically open.

The NC pin can be connected to VDD or VSS.

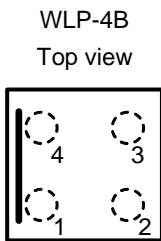

**Figure 3**

**Table 4**

(S-5815A/16A Series)

Pin No.	Pin Name	Pin Description
1	VDD	Power supply pin
2	VSS <sup>*1</sup>	GND pin
3	VSS <sup>*1</sup>	GND pin
4	VOUT	Output voltage pin

\*1. Connect both VSS pins to GND.

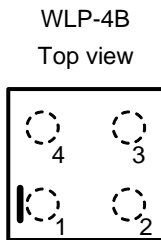

**Figure 4**

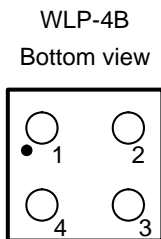

**Figure 5**

■ **Absolute Maximum Ratings**

**Table 5**

(Ta = +25°C unless otherwise specified)

Item	Symbol	Absolute Maximum Rating	Unit
Power supply pin voltage	$V_{DD}$	$V_{SS} - 0.3$ to $V_{SS} + 12.0$	V
Output voltage	$V_{OUT}$	$V_{SS} - 0.3$ to $V_{DD} + 0.3$	V
Power dissipation	$P_D$	140 (When not mounted on board)	mW
		300 <sup>*1</sup>	mW
		290 <sup>*1</sup>	mW
Operating ambient temperature	$T_{opr}$	-40 to +100	°C
Storage temperature	$T_{stg}$	-40 to +125	°C

\*1. When mounted on board

[Mounted board]

- (1) Board size : 114.3 mm × 76.2 mm × t1.6 mm
- (2) Board name : JEDEC STANDARD51-7

**Caution** The absolute maximum ratings are rated values exceeding which the product could suffer physical damage. These values must therefore not be exceeded under any conditions.

## ■ Electrical Characteristics

### 1. S-5813A/15A Series

**Table 6**  
( $T_a = +25^\circ\text{C}$ ,  $V_{DD} = 5.0\text{ V}$ ,  $I_{OUT} = 0\text{ A}$  unless otherwise specified)

Item	Symbol	Conditions	Min.	Typ.	Max.	Unit	Test Circuit
Power supply voltage	$V_{DD}$	–	2.40	–	10.00	V	1
		$T_a = -20^\circ\text{C}$ to $+100^\circ\text{C}$	2.65	–	10.00	V	1
		$T_a = -30^\circ\text{C}$ to $+100^\circ\text{C}$	2.90	–	10.00	V	1
Output voltage	$V_{OUT}$	$T_a = -30^\circ\text{C}$	2.528	2.582	2.636	V	1
		$T_a = +30^\circ\text{C}$	1.886	1.940	1.994	V	1
		$T_a = +100^\circ\text{C}$	1.091	1.145	1.199	V	1
Temperature sensitivity	$V_{SE}$	$T_a = -30^\circ\text{C}$ to $+100^\circ\text{C}$	-11.31	-11.04	-10.77	mV/°C	–
Nonlinearity	$\Delta N_L$	$T_a = -20^\circ\text{C}$ to $+80^\circ\text{C}$	–	$\pm 0.5$	–	%	–
Operating temperature range	$T_{opr}$	–	-40	–	100	°C	–
Current consumption	$I_{DD}$	–	–	4.0	8.0	$\mu\text{A}$	1
Line regulation	$\Delta V_{OUT1}$	$V_{DD} = 2.4\text{ V}$ to $10.0\text{ V}$	–	–	0.05	%/V	2
Load regulation <sup>*1</sup>	$\Delta V_{OUT2}$	$I_{OUT} = 0\ \mu\text{A}$ to $200\ \mu\text{A}$	–	–	1.0	mV	2

\*1. Do not flow current into the output voltage pin.

### 2. S-5814A/16A Series

**Table 7**  
( $T_a = +25^\circ\text{C}$ ,  $V_{DD} = 5.0\text{ V}$ ,  $I_{OUT} = 0\text{ A}$  unless otherwise specified)

Item	Symbol	Conditions	Min.	Typ.	Max.	Unit	Test Circuit
Power supply voltage	$V_{DD}$	–	2.40	–	10.00	V	1
		$T_a = -20^\circ\text{C}$ to $+100^\circ\text{C}$	2.65	–	10.00	V	1
		$T_a = -30^\circ\text{C}$ to $+100^\circ\text{C}$	2.90	–	10.00	V	1
Output voltage	$V_{OUT}$	$T_a = -30^\circ\text{C}$	2.555	2.582	2.609	V	1
		$T_a = +30^\circ\text{C}$	1.913	1.940	1.967	V	1
		$T_a = +100^\circ\text{C}$	1.118	1.145	1.172	V	1
Temperature sensitivity	$V_{SE}$	$T_a = -30^\circ\text{C}$ to $+100^\circ\text{C}$	-11.31	-11.04	-10.77	mV/°C	–
Nonlinearity	$\Delta N_L$	$T_a = -20^\circ\text{C}$ to $+80^\circ\text{C}$	–	$\pm 0.5$	–	%	–
Operating temperature range	$T_{opr}$	–	-40	–	100	°C	–
Current consumption	$I_{DD}$	–	–	4.0	8.0	$\mu\text{A}$	1
Line regulation	$\Delta V_{OUT1}$	$V_{DD} = 2.4\text{ V}$ to $10.0\text{ V}$	–	–	0.05	%/V	2
Load regulation <sup>*1</sup>	$\Delta V_{OUT2}$	$I_{OUT} = 0\ \mu\text{A}$ to $200\ \mu\text{A}$	–	–	1.0	mV	2

\*1. Do not flow current into the output voltage pin.

■ Test Circuits

1.

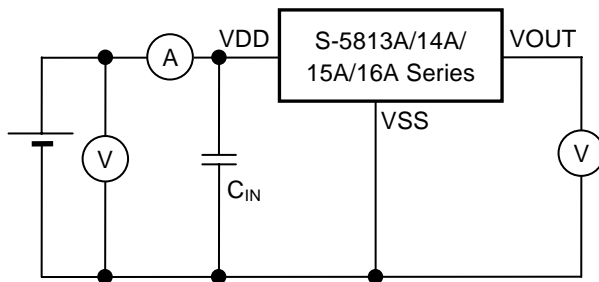

Figure 6

2.

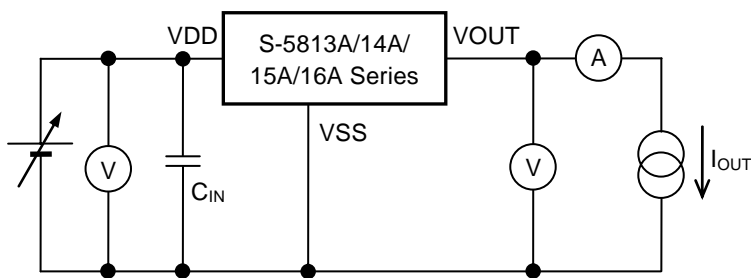

Figure 7



## ■ Explanation of Terms

### 1. Output voltage ( $V_{OUT}$ )

$V_{OUT}$  indicates the output voltage at  $T_a = -30^\circ\text{C}$ ,  $T_a = +30^\circ\text{C}$ , and  $T_a = +100^\circ\text{C}$ .

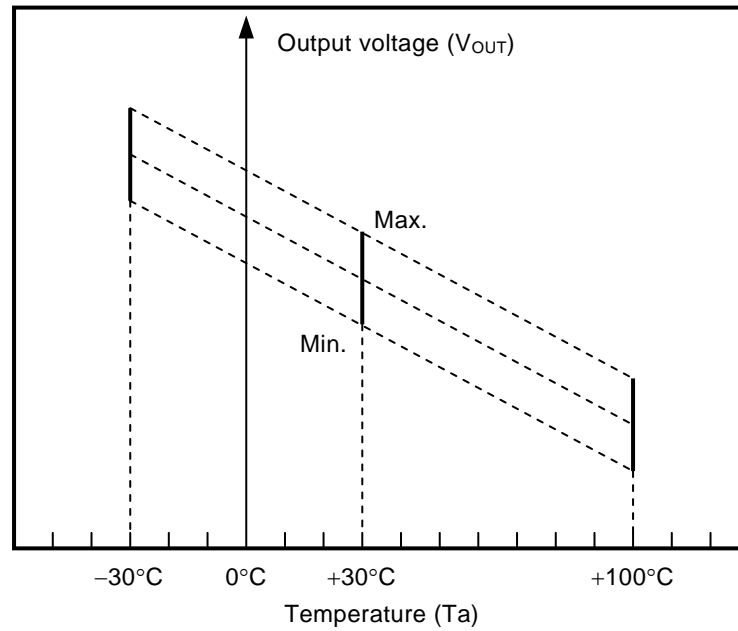

Figure 8

**2. Temperature sensitivity ( $V_{SE}$ )**

$V_{SE}$  indicates the temperature coefficient of the output voltage calculated using the output voltage at  $T_a = -30^\circ\text{C}$  and  $T_a = +100^\circ\text{C}$ .

$V_{SE}$  is calculated using the following formula.

$$V_{SE} = \frac{V_{OUT}^{*1} - V_{OUT}^{*2}}{130^{*3}}$$

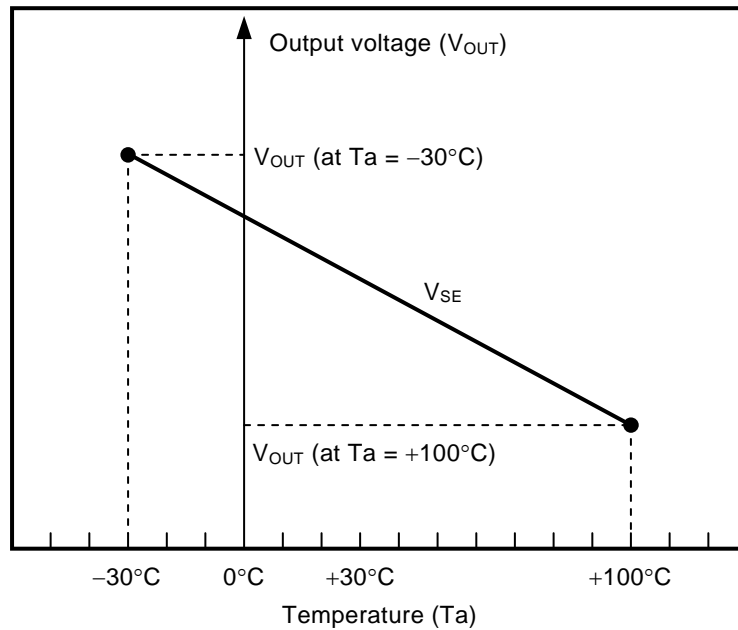

**Figure 9**

- \*1.  $V_{OUT}$  value [V] at  $T_a = +100^\circ\text{C}$ .
- \*2.  $V_{OUT}$  value [V] at  $T_a = -30^\circ\text{C}$ .
- \*3. The difference of the temperature [ $^\circ\text{C}$ ] from  $T_a = +100^\circ\text{C}$  to  $T_a = -30^\circ\text{C}$ .

### 3. Nonlinearity ( $\Delta N_L$ )

$\Delta N_L$  indicates the nonlinearity of the output voltage and is defined as the difference of the characteristic curve of the output voltage and the approximation line shown below.

$\Delta N_L$  is calculated using the following formula.

$$\Delta N_L = \frac{a^{*1}}{b^{*2}} \times 100$$

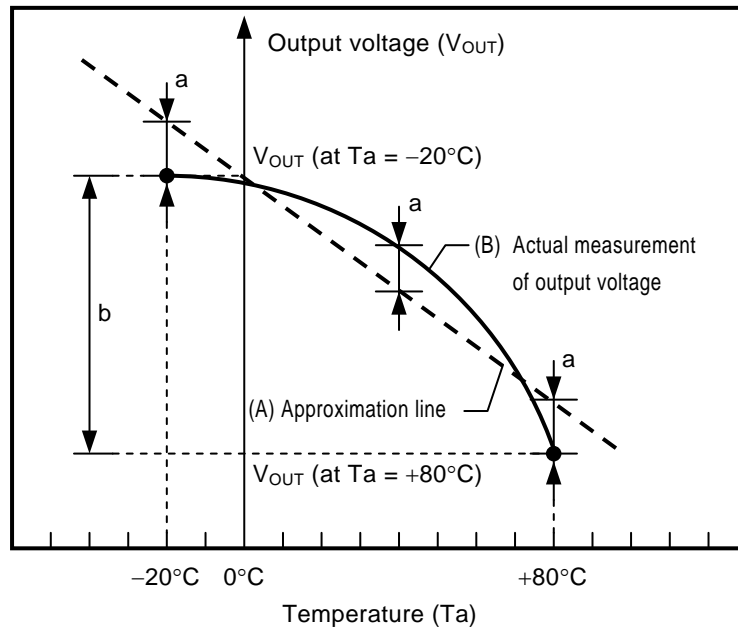

- \*1. The maximum deviation of the actual measurement of output voltage (B) and an approximation line (A) in temperature within  $-20^{\circ}\text{C}$  to  $+80^{\circ}\text{C}$ . The approximation line is the line drawn so that "a" should be the minimum value.
- \*2. The difference of the output voltage within  $-20^{\circ}\text{C}$  to  $+80^{\circ}\text{C}$ .

Figure 10

### 4. Line regulation ( $\Delta V_{OUT1}$ )

$\Delta V_{OUT1}$  indicates the output voltage dependency of the input voltage. That is, the values express how the output voltage changes, when input voltage is changed under the condition that output current is fixed.

### 5. Load regulation ( $\Delta V_{OUT2}$ )

$\Delta V_{OUT2}$  indicates the output voltage dependency of the output current. That is, the values express how the output voltage changes, when output current is changed under the condition that input voltage is fixed.

## ■ Precautions

- Wiring patterns for the VDD pin, VOUT pin, and VSS pin should be designed to hold low impedance.
- In this IC, if load capacitance of the VOUT pin is large, VOUT pin voltage may oscillate. It is recommended not to use the external capacitor between the VOUT and VSS pin. When using an external capacitor, mount it near the VOUT pin. When connecting an A/D converter etc. to the VOUT pin, the input pin capacitance of the A/D converter and the parasitic capacitance component between wires are included as load capacitance. To prevent oscillation, it is recommended to use the following output load condition.

Load capacitance of VOUT pin ( $C_L$ ) : 2.2  $\mu$ F or less

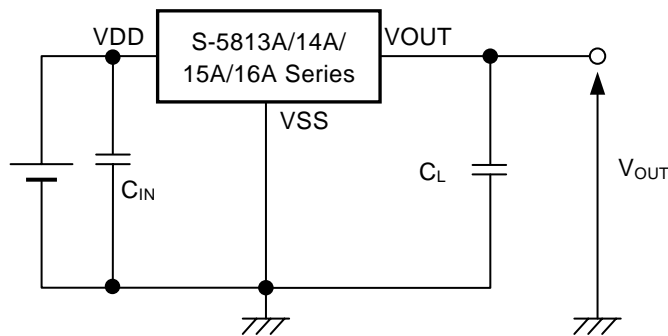

Figure 11

**Caution** The above connection diagram and constant will not guarantee successful operation. Perform through evaluation using the actual application to set the constant.

- Please do not connect a pull-up resistor to the output voltage pin.
- The application condition for input voltage, output voltage and load voltage must not exceed the package power dissipation.
- Do not apply an electrostatic discharge to this IC that exceeds the performance ratings of the built-in electrostatic protection circuit.
- SII claims no responsibility for any disputes arising out of or in connection with any infringement by products including this IC of patents owned by a third party.

## ■ Precautions for WLP package

- The side of device silicon substrate is exposed to the marking side of device package. Since this portion has lower strength against the mechanical stress than the standard plastic package, chip, crack, etc should be careful of the handling of a package enough. Moreover, the exposed side of silicon has electrical potential of device substrate, and needs to be kept out of contact with the external potential.
- In this package, the overcoat of the resin of translucence is carried out on the side of device area. Keep it mind that it may affect the characteristic of a device when exposed a device in the bottom of a high light source.

■ Characteristics (Typical Data)

1. Output voltage ( $V_{OUT}$ ) vs. Temperature ( $T_a$ )

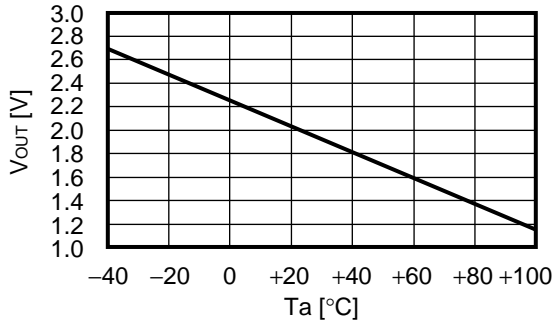

2. Current consumption ( $I_{DD}$ ) vs. Temperature ( $T_a$ )

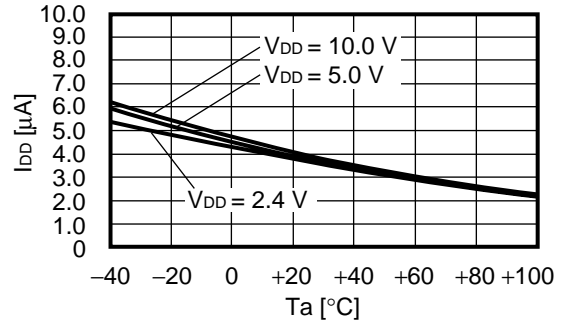

3. Error range of each temperature

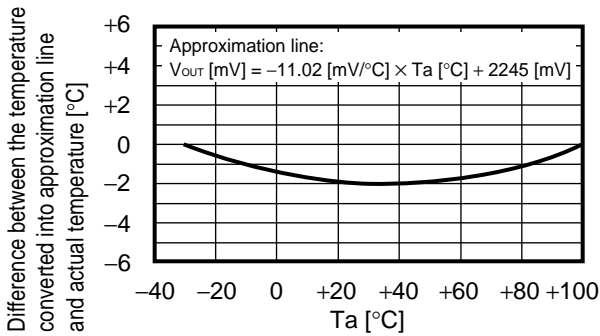

4. Current consumption ( $I_{DD}$ ) vs. Power supply voltage ( $V_{DD}$ )

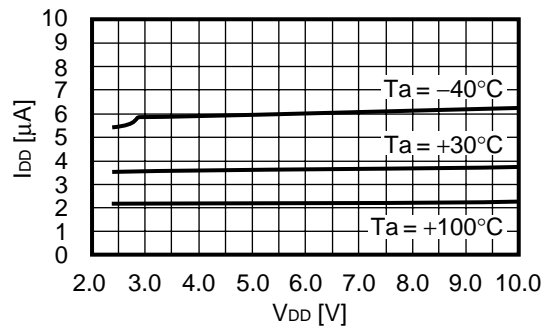

5. Output voltage ( $V_{OUT}$ ) vs. Power supply voltage ( $V_{DD}$ )

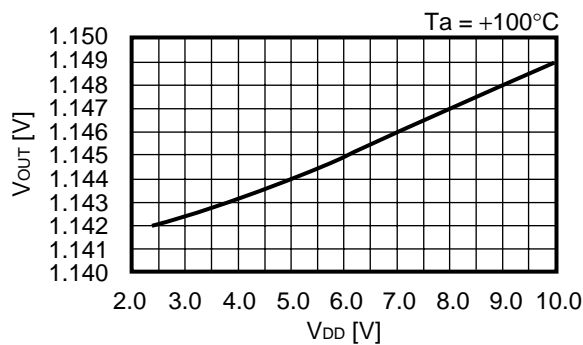
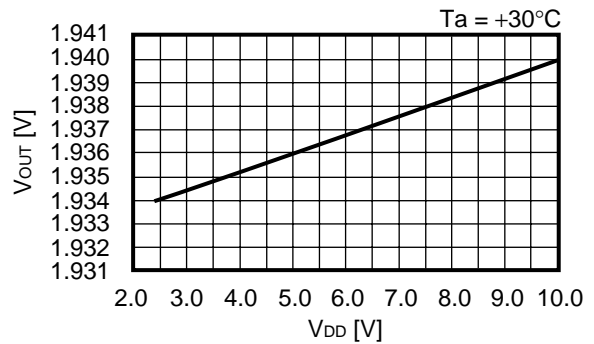
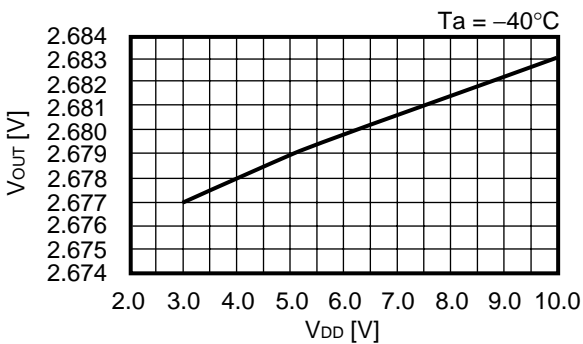

**6. Output voltage ( $V_{OUT}$ ) vs. Load current ( $I_{OUT}$ )**

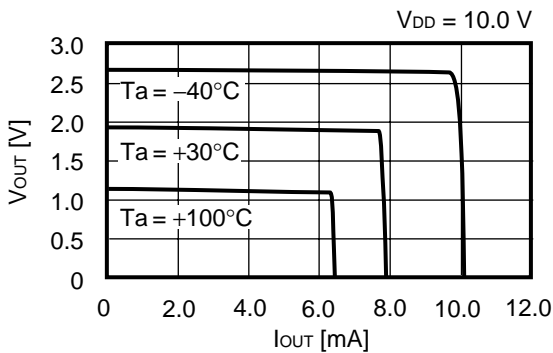
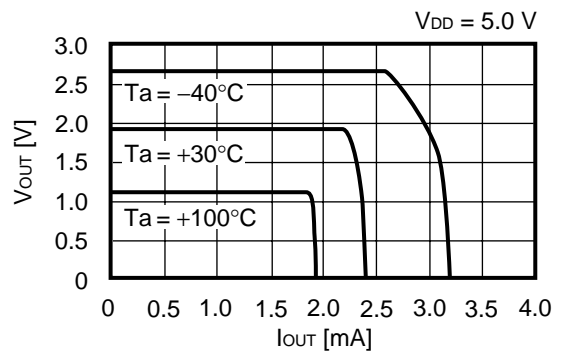
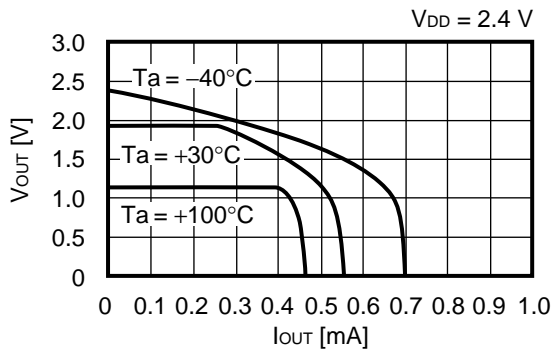

**7. Heat response Output voltage ( $V_{OUT}$ ) vs. Time (t)**

When packages are put into the air of +100°C from the air of +25°C

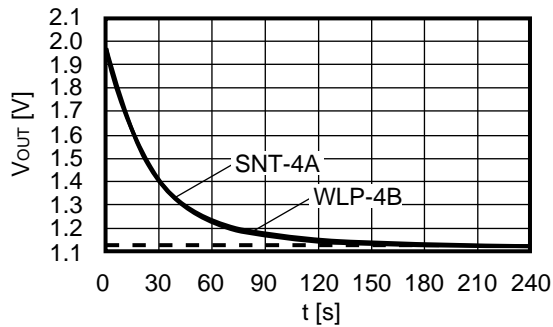

When packages are put into the liquid of +100°C from the air of +25°C

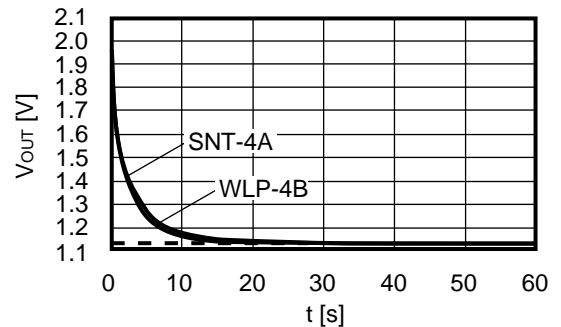

**8. Start up response**

$T_a = +25^\circ\text{C}$ ,  $C_L = 100\text{ pF}$ ,  $R_L = 10\text{ M}\Omega$

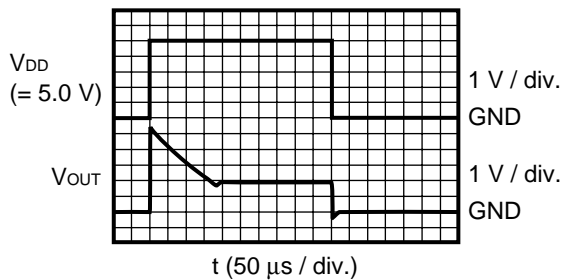

$T_a = +25^\circ\text{C}$ ,  $C_L = 100\text{ pF}$ ,  $R_L = 10\text{ M}\Omega$

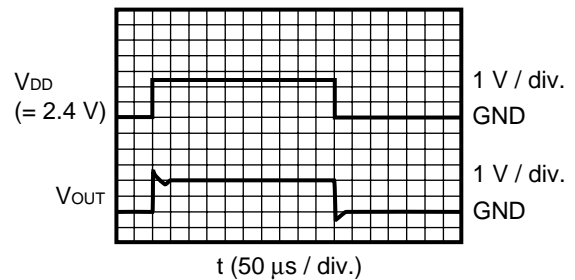

■ **Marking Specification**

SNT-4A  
 Top view

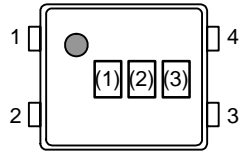

(1) to (3) : Product code (refer to **Product name vs. Product code**)

**Product name vs. Product code**

Product Name	Product Code		
	(1)	(2)	(3)
S-5813A-I4T1x	D	R	C
S-5814A-I4T1x	D	R	D

**Remark1.** x: G or U

2. Please select products of environmental code = U for Sn 100%, halogen-free products.

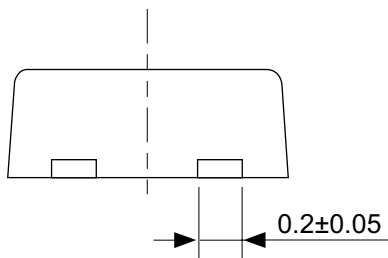
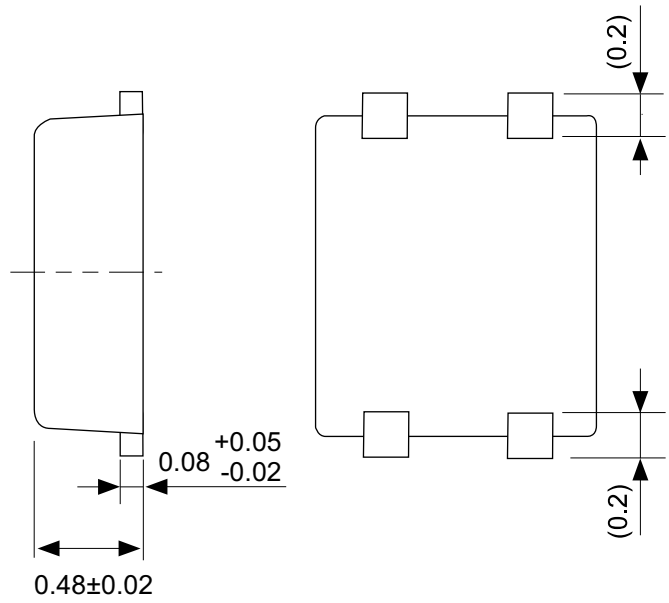
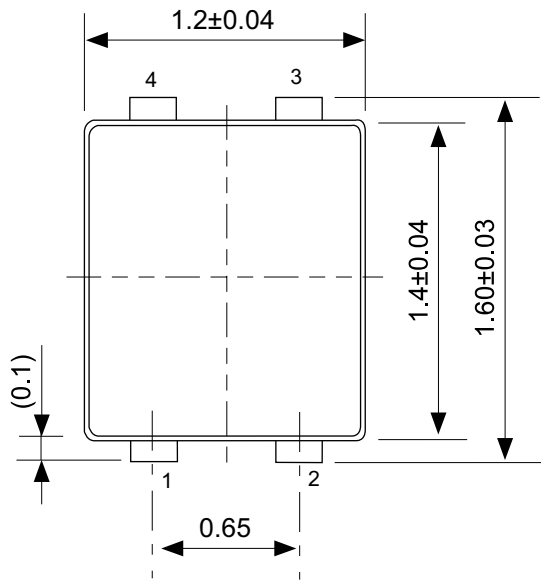

No. PF004-A-P-SD-4.0

TITLE	SNT-4A-A-PKG Dimensions
No.	PF004-A-P-SD-4.0
SCALE	
UNIT	mm
Seiko Instruments Inc.	



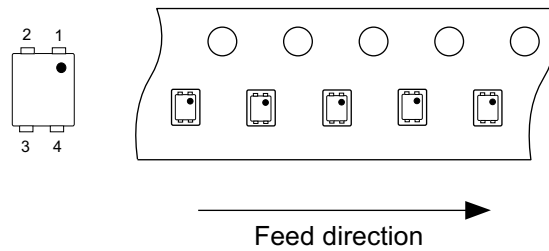
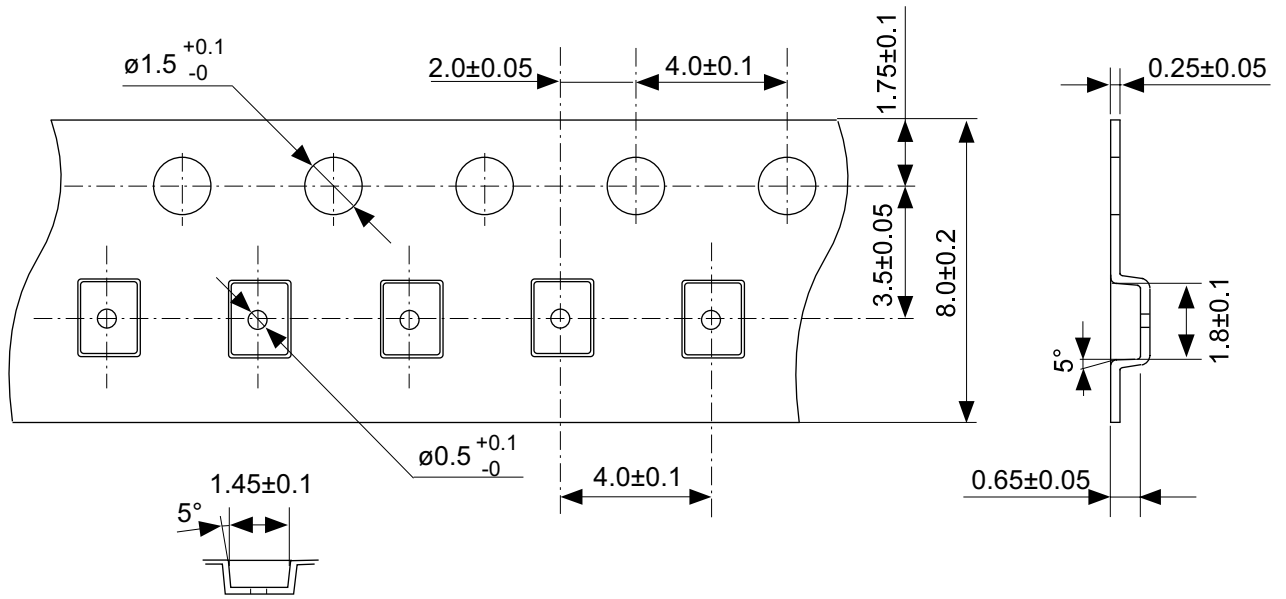

No. PF004-A-C-SD-1.0

TITLE	SNT-4A-A-Carrier Tape
No.	PF004-A-C-SD-1.0
SCALE	
UNIT	mm
Seiko Instruments Inc.	

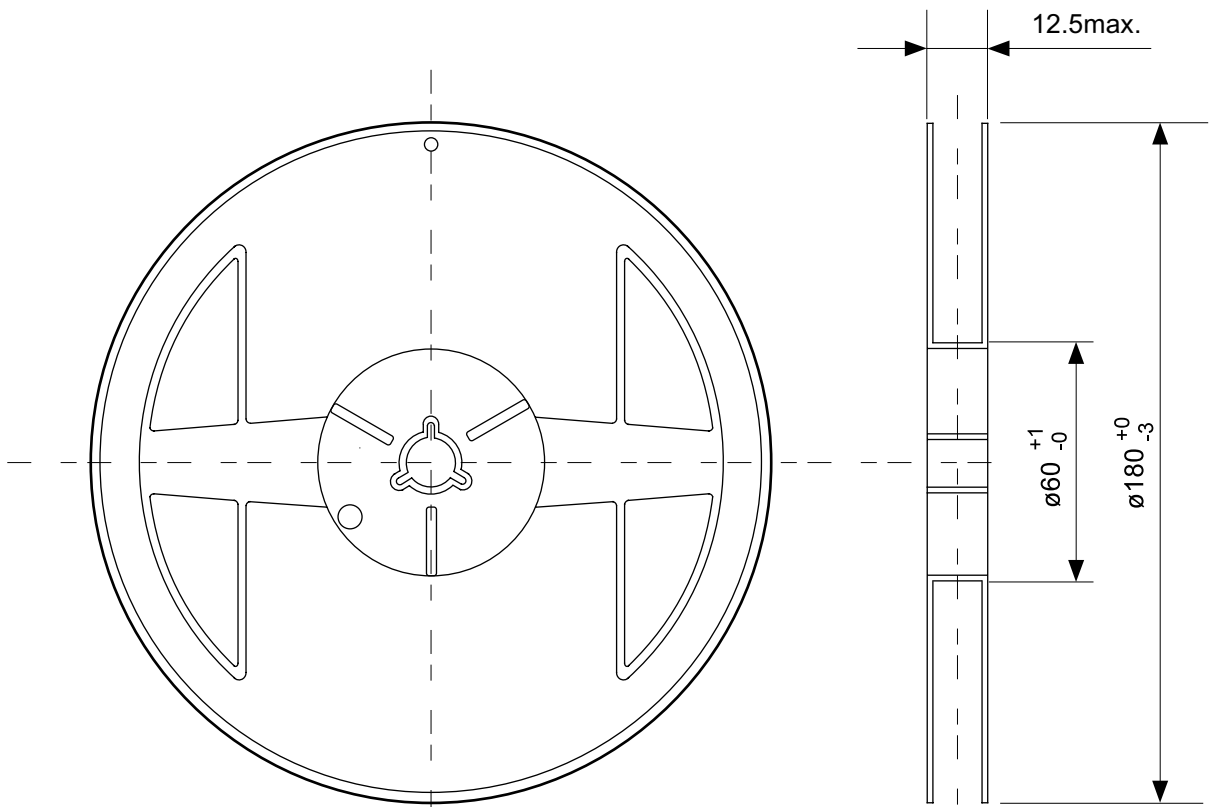

Enlarged drawing in the central part

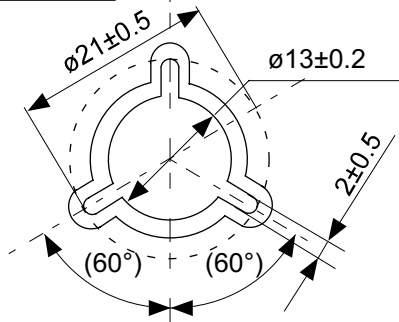

No. PF004-A-R-SD-1.0

TITLE	SNT-4A-A-Reel		
No.	PF004-A-R-SD-1.0		
SCALE		QTY.	5,000
UNIT	mm		
Seiko Instruments Inc.			

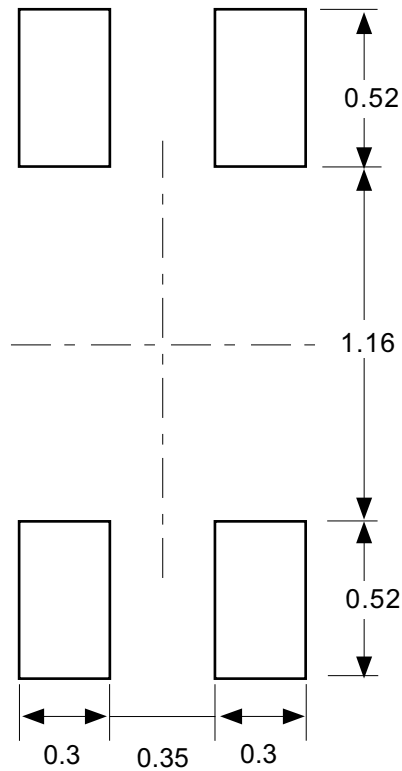

Caution Making the wire pattern under the package is possible. However, note that the package may be upraised due to the thickness made by the silk screen printing and of a solder resist on the pattern because this package does not have the standoff.

注意 パッケージ下への配線パターン形成は可能ですが、本パッケージはスタンドオフが無いので、パターン上のレジスト厚み、シルク印刷の厚みによってパッケージが持ち上がる場合がありますのでご配慮ください。

No. PF004-A-L-SD-3.0

TITLE	SNT-4A-A-Land Recommendation
No.	PF004-A-L-SD-3.0
SCALE	
UNIT	mm
Seiko Instruments Inc.	

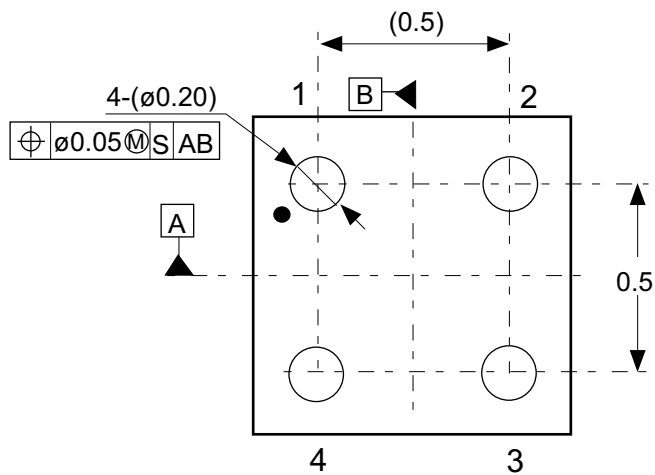
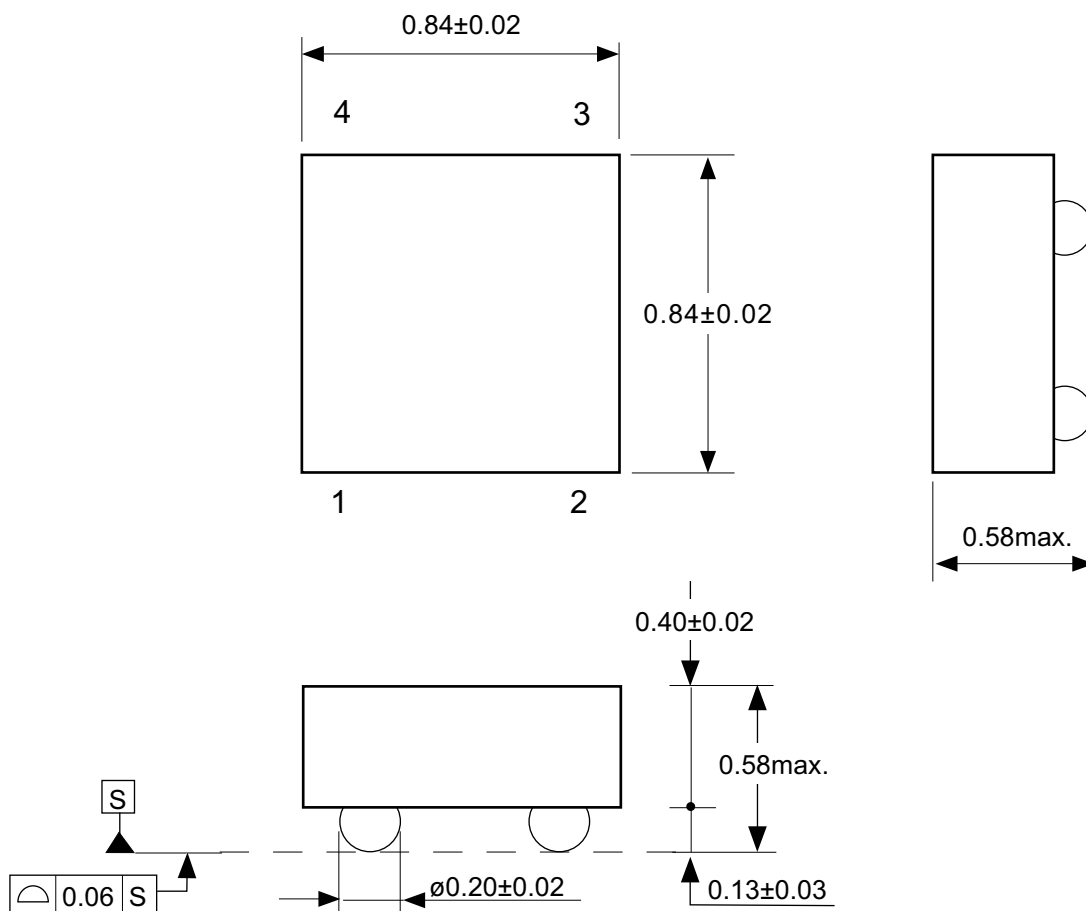

Pin No.	Symbol
1	VDD
2	VSS2
3	VSS1
4	VOU

No. HB004-B-P-SD-2.0

TITLE	WLP-4B-B-PKG Dimensions (S-8150/60A , S-5815/16A)
No.	HB004-B-P-SD-2.0
SCALE	
UNIT	mm
Seiko Instruments Inc.	

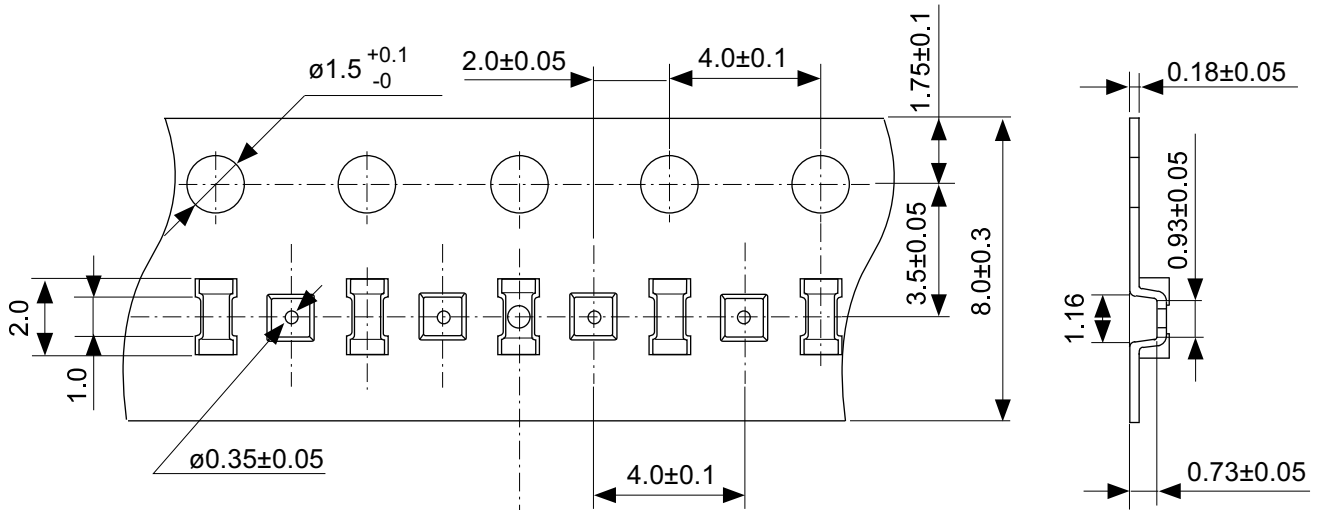

Count mark (R0.3, Depth 0.2)  
(Every 10 pockets)

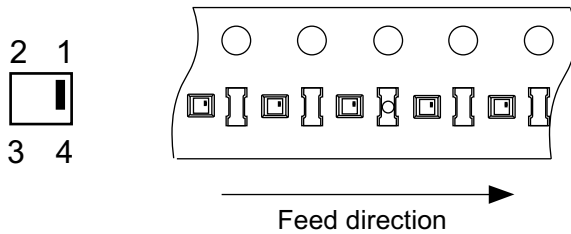
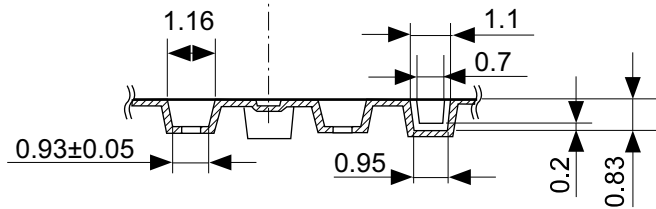

No. HB004-B-C-SD-1.1

TITLE	WLP-4B-B-Carrier Tape (S-8150/60A, S-5815/16A)
No.	HB004-B-C-SD-1.1
SCALE	
UNIT	mm
Seiko Instruments Inc.	

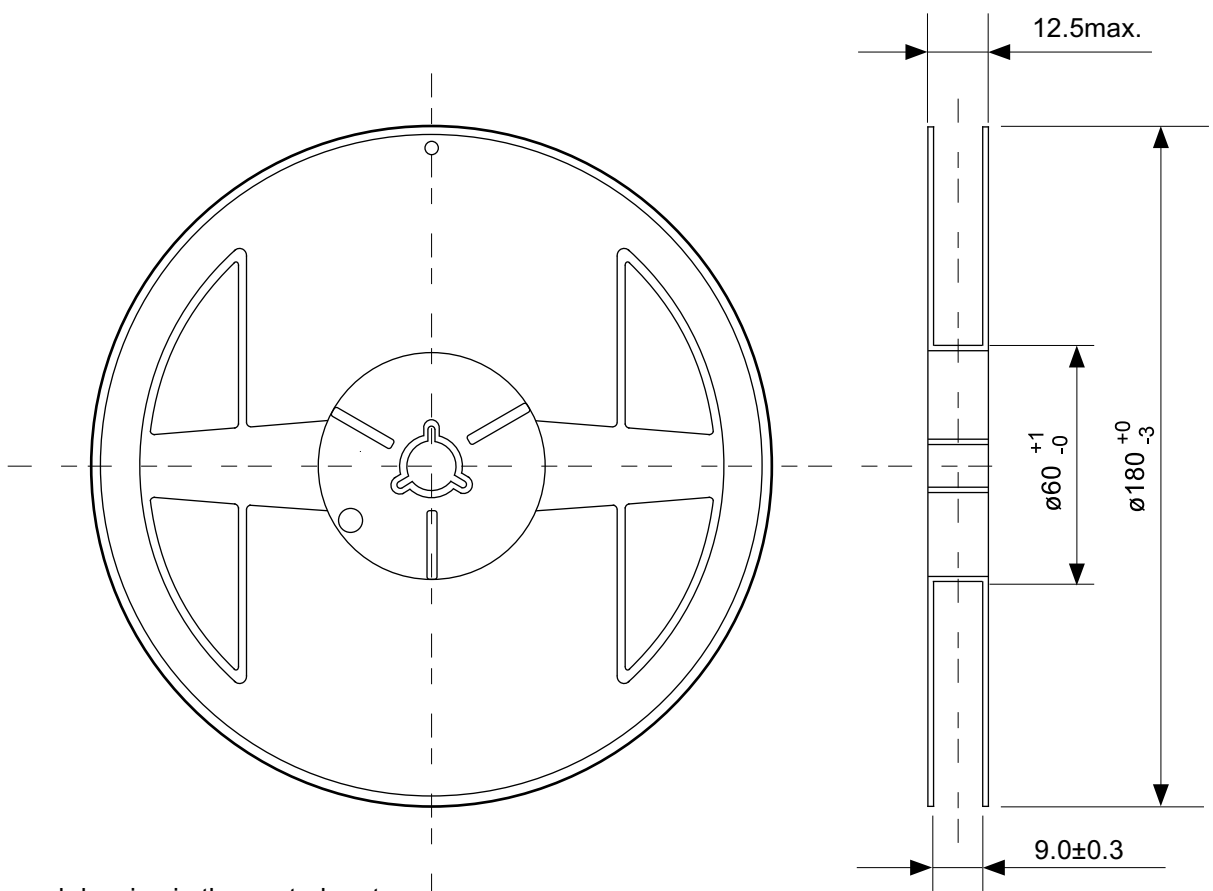

Enlarged drawing in the central part

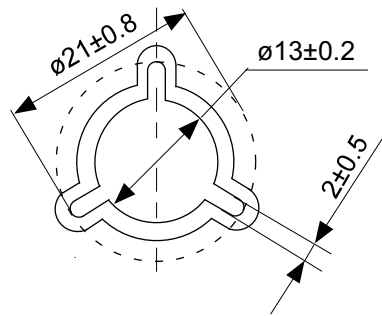

No. HB004-B-R-SD-1.1

TITLE	WLP-4B-B-Reel (S-8150/60A , S-5815/16A)		
No.	HB004-B-R-SD-1.1		
SCALE		QTY.	3,000
UNIT	mm		
Seiko Instruments Inc.			



Seiko Instruments Inc.  
[www.sii-ic.com](http://www.sii-ic.com)

- The information described herein is subject to change without notice.
- Seiko Instruments Inc. is not responsible for any problems caused by circuits or diagrams described herein whose related industrial properties, patents, or other rights belong to third parties. The application circuit examples explain typical applications of the products, and do not guarantee the success of any specific mass-production design.
- When the products described herein are regulated products subject to the Wassenaar Arrangement or other agreements, they may not be exported without authorization from the appropriate governmental authority.
- Use of the information described herein for other purposes and/or reproduction or copying without the express permission of Seiko Instruments Inc. is strictly prohibited.
- The products described herein cannot be used as part of any device or equipment affecting the human body, such as exercise equipment, medical equipment, security systems, gas equipment, or any apparatus installed in airplanes and other vehicles, without prior written permission of Seiko Instruments Inc.
- Although Seiko Instruments Inc. exerts the greatest possible effort to ensure high quality and reliability, the failure or malfunction of semiconductor products may occur. The user of these products should therefore give thorough consideration to safety design, including redundancy, fire-prevention measures, and malfunction prevention, to prevent any accidents, fires, or community damage that may ensue.