

SERIES TL 3342 SWITCHES

TACT SWITCHES SMT

TACT SWITCHES

NAVIGATION SWITCHES

PUSHBUTTON SWITCHES

TOGGLE SWITCHES

ROCKER SWITCHES

SLIDE SWITCHES

SNAP-ACTION SWITCHES

DIP SWITCHES

KEYLOCK SWITCHES

ROTARY SWITCHES

DETECTOR SWITCHES

CAP OPTIONS

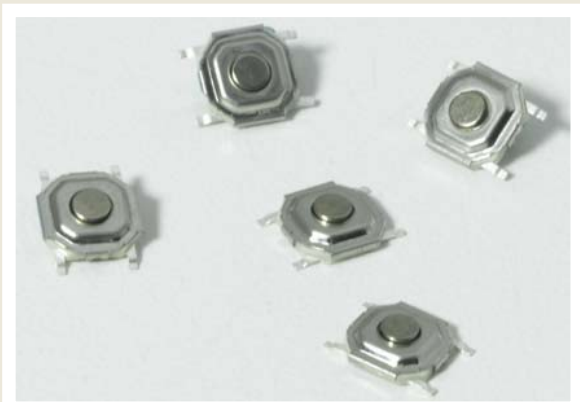

FEATURES & BENEFITS

- ▶ Low profile design
- ▶ Positive tactile response

APPLICATIONS/MARKETS

- ▶ Telecommunications
- ▶ Consumer Electronics
- ▶ Audio/visual
- ▶ Medical
- ▶ Testing/instrumentation
- ▶ Computer/servers/peripherals

SPECIFICATIONS

Contact Rating:	50mA @ 12 VDC
Life Expectancy:	100,000 cycles typical
Contact Resistance:	20mΩ max. intial @ 2-4 VDC, 100mA
Insulation Resistance:	100MΩ
Dielectric Strength:	1,000 Vrms at sea level
Actuation Force:	160± 50 gf, 260± 50 gf

MATERIALS

Housing:	Polyphenylene Sulfide (PPS) or 4/6 Nylon
Actuator:	Polyphenylene Sulfide (PPS) or 4/6 Nylon
Cover:	Tin plated steel
Contacts:	Silver-clad phosphor bronze
Terminals:	Silver-clad brass

HOW TO ORDER

SERIES	MODEL NO.	ACTUATOR ("L" Dimension)	OPERATING FORCE	CONTACT MATERIAL	TERMINATION
TL	3342	(None) = Std.	F160 F260	Q = Silver	G = Gull Wing

Example Ordering Number

TL-3342-F160-Q-G

Specifications subject to change without notice.

TL 3342

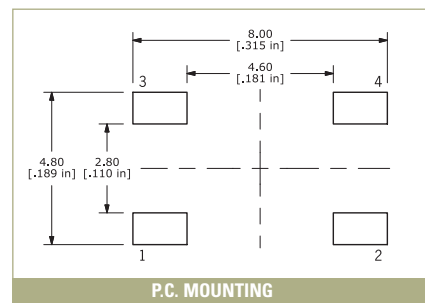
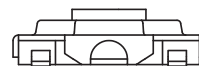
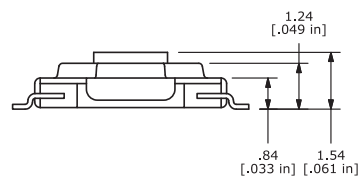
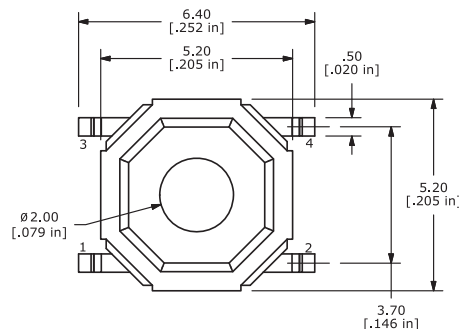
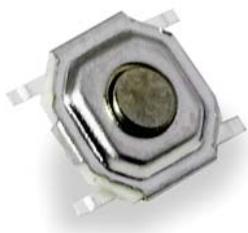

P.C. MOUNTING

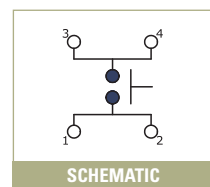

SCHEMATIC