

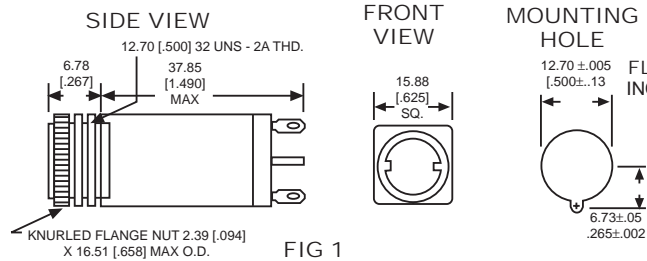

554 SERIES SOLID STATE, HALL EFFECT SWITCHES

MOMENTARY ACTION 4.5 VDC TO 16 VDC

PART NO.	ACCEPTS CAP SIZE	CONTACT CIRCUIT	FIG
554-7321	ALL	SPST N.O.	1
554-7321-211	5/8" SQ.	SPST N.O.	2
554-7321-411	3/4" SQ.	SPST N.O.	3
554-7321-511	3/4" X 1"	SPST N.O.	4



Uses:
T-1 3/4
MIDGET
FLANGE BASE
INCANDESCENT
LAMP

554 SERIES INDICATORS

PART NO.	ACCEPTS CAP SIZE	FIG
554-0001	ALL	1
554-0001-211	5/8" SQ.	2
554-0001-411	3/4" SQ.	3
554-0001-511	3/4" X 1"	4
554-4001-411	DUAL LAMP	5

Caps Ordered Separately, see Page 25

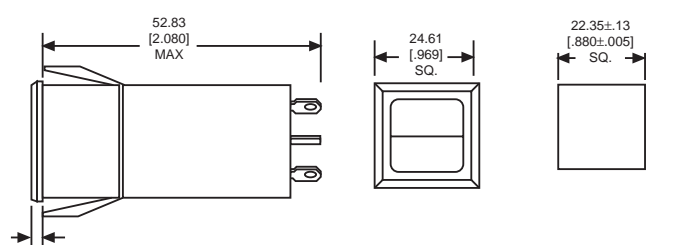
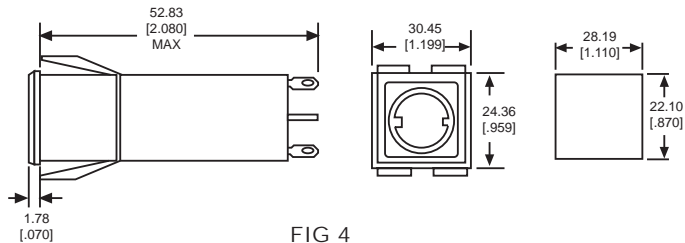
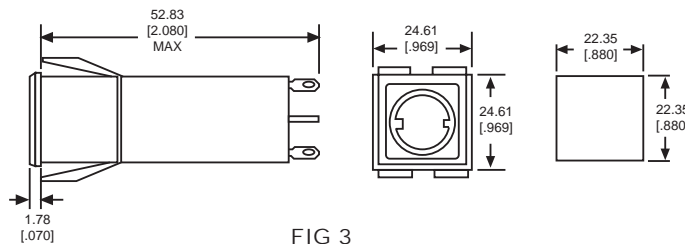
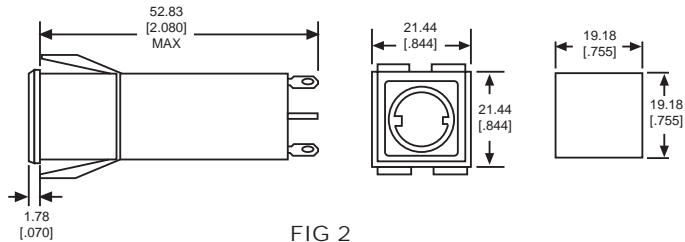

565 SERIES BARRIERS

PART NO.	DESCRIPTION	FOR USE WITH BEZEL SUFFIX
565-0701	5/8" END BARRIER	-211 OR -311
565-0711	5/8" CENTER BARRIER	-211 OR -311
565-0721	3/4" END BARRIER	-411 OR -511
565-0731	3/4" CENTER BARRIER	-411 OR -511

GENERAL INFORMATION:

Barriers may be used with Snap-In Bezel Mounting Switches to provide safer separation between switch caps, thereby minimizing accidental actuation of the wrong switch. "End" and "center" barrier are used if two or more switches are mounted in common hole cutout. For individual switch mounting, two end barriers are used.

INSERTION:

The barriers are held to the side of the switch by hand and inserted as one unit. The end or side barrier becomes captured upon insertion into a panel and appear to be one complete assembly.

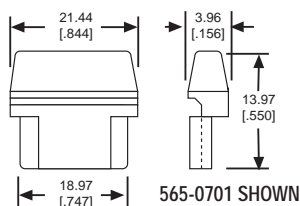

501 SERIES PCB SOCKETS

WAVE SOLDERABLE PCB SOCKETS FOR 554 SWITCHES

PART NO.	FOR SWITCH
501-1001	554-00
501-1001	554-11
501-2001	554-12
501-1001	554-21
501-2001	554-22
501-1002	554-31
501-2002	554-32
501-1002	554-73

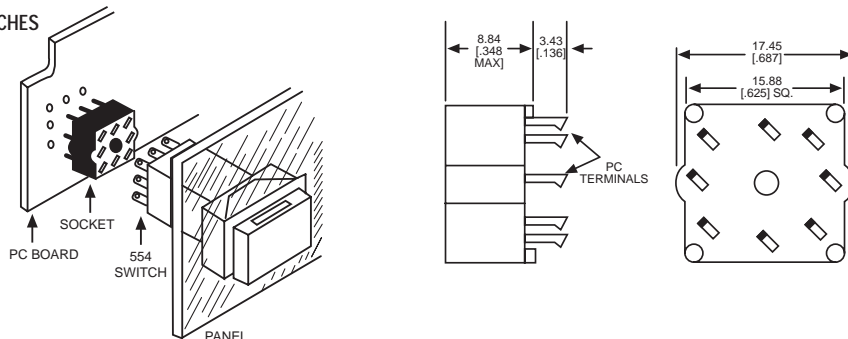

Material: All plastic switch components made from 94V-0 plastic

Neon and incandescent lamp information on Pages 35 and 36.

Dimensions in mm [inches]

