

Safety Interlock Switches

D4BS



Safety-Door Switch

- The special operation key activates a direct opening mechanism to open the contacts and shut off control circuits when protective doors are opened on machine tools or other equipment
- Conforms to EN (TÜV) standards corresponding to the CE marking.
- Certified by UL and CSA standards.
- The Switch contact is opened by a direct opening mechanism (NC-contacts only) when the protective cover is opened. The EN-certified direct opening mechanism is indicated by  on the Switch
- Malfunctions and false operation prevented by special Operation Key
- Wide temperature range specifications: -40 to 80°C
- Degree of protection of the switch box: IP67 (EN60947-5-1)
- Series includes models with gold-plated contacts for handling the microload range



G

Specifications

Standards and EC Directives

Conforms to the following EC Directives:

- Machinery Directive
- Low Voltage Directive
- EN50041
- EN 1088

Certified Standards

Certification body	Standard	File No.
TÜV Rheinland	EN 60947-5-1 (certified direct opening)	J50084815
UL	UL 508	E76675
CSA	CSA C22.2 No. 14	LR45746
CQC (CCC)	GB14048.5	2003010305073833

Certified Standard Ratings

TÜV (EN 60947-5-1), CCC (GB14048.5)

Item	Utilization category	AC-15
Rated operating current (Ie)		2 A
Rated operating voltage (Ue)		400 V

Note: Use a 10 A fuse type gI or gG that conforms to IEC 60269 as a short-circuit protection device.

UL/CSA (UL 508, CSA C22.2 No. 14)
A600

Rated voltage	Carry current	Current (A)		Volt-amperes (VA)	
		Make	Break	Make	Break
120 VAC	10 A	60	6	7,200	720
240 VAC		30	3		
480 VAC		15	1.5		
600 VAC		12	1.2		

Connections

Contact Form

Diagrams show state with key inserted.

Model	Contact	Contact form	Operating pattern	Remarks
D4BS-□5□S	1NC/1NO			<p>Only NC contact 11-12 has a certified direct opening mechanism. (→)</p> <p>Terminals 11-12 and 23-24 can be used as unlike poles.</p>
D4BS-□A□S	2NC			<p>NC contacts 11-12 and 21-22 have a certified direct opening mechanism. (→)</p> <p>Terminals 11-12 and 21-22 can be used as unlike poles.</p>

Note: The terminal numbers are in accordance with EN50013, and the contact symbols are in accordance with IEC60947-5-1.

Dimensions and Operating Characteristics

(mm)

G

Switches

1-conduit

D4BS-1□□S
D4BS-2□□S
D4BS-3□□S

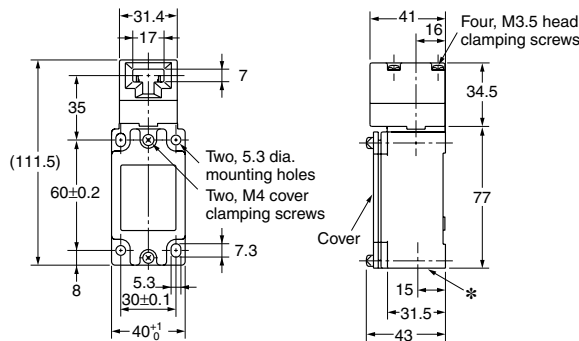
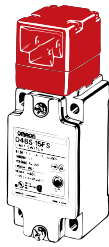

Operating characteristics	Model	D4BS-1□□S D4BS-2□□S D4BS-3□□S
Key insertion force		19.61 N max.
Key extraction force		19.61 N max.
Pretravel (PT)		10±5 mm
Total travel		23 mm min.
Direct opening force		19.61 N min.
Direct opening stroke		20 mm min.

3-conduit

D4BS-5□□S
D4BS-6□□S
D4BS-7□□S

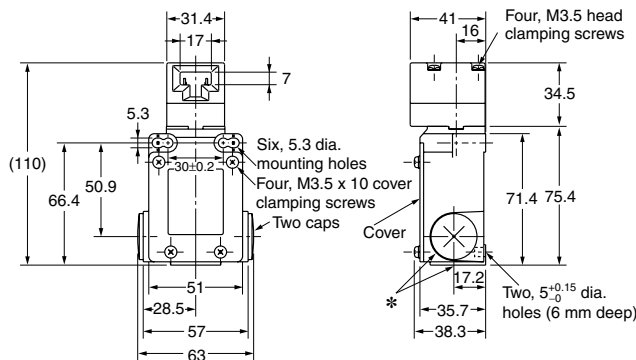
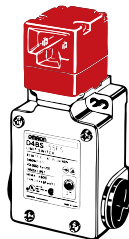

Operating characteristics	Model	D4BS-5□□S D4BS-6□□S D4BS-7□□S
Key insertion force		19.61 N max.
Key extraction force		19.61 N max.
Pretravel (PT)		10±5 mm
Total travel		23 mm min.
Direct opening force		19.61 N min.
Direct opening stroke		20 mm min.

Notes: 1. Unless otherwise specified, a tolerance of ±0.4 mm applies to all dimensions.

2. There are fluctuations in the contact ON/OFF timing for 2NC contacts. Confirm performance before application.

*The conduit thread varies with the model as follows:

D4BS-1□□S, D4BS-5□□S: Pg 13.5

D4BS-2□□S, D4BS-6□□S: G1/2

D4BS-3□□S, D4BS-7□□S: 1/2-14NPT

Dimensions and Operating Characteristics (continued)

(mm)

With Operation Key Inserted

D4BS-1□□S + D4BS-K1
D4BS-2□□S + D4BS-K1
D4BS-3□□S + D4BS-K1

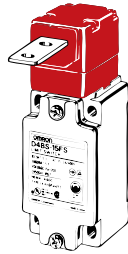

D4BS-1□□S + D4BS-K2
D4BS-2□□S + D4BS-K2
D4BS-3□□S + D4BS-K2

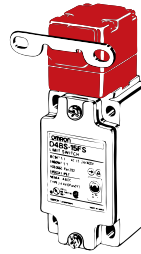

D4BS-1□□S + D4BS-K3
D4BS-2□□S + D4BS-K3
D4BS-3□□S + D4BS-K3

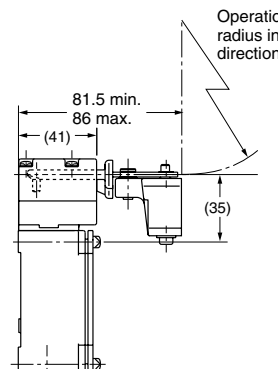
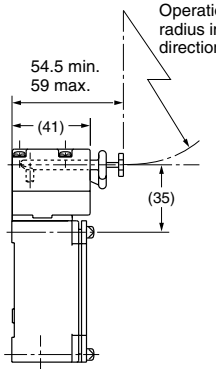
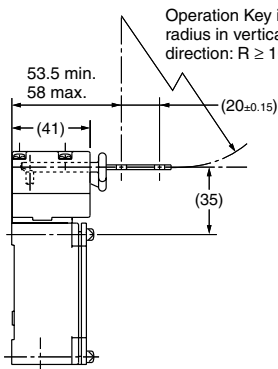
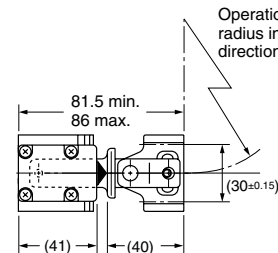
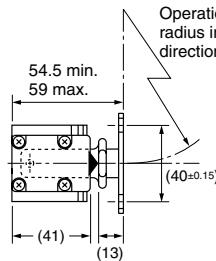
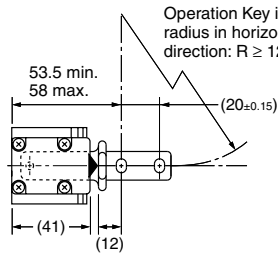
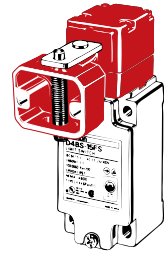

Operation Keys

D4BS-K1

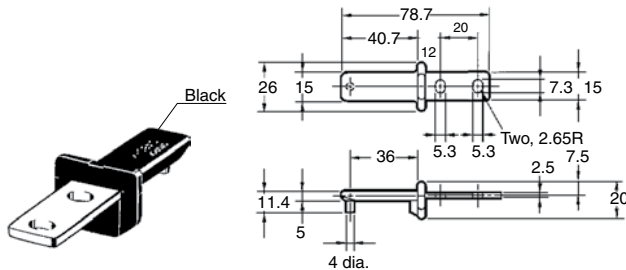

D4BS-K3

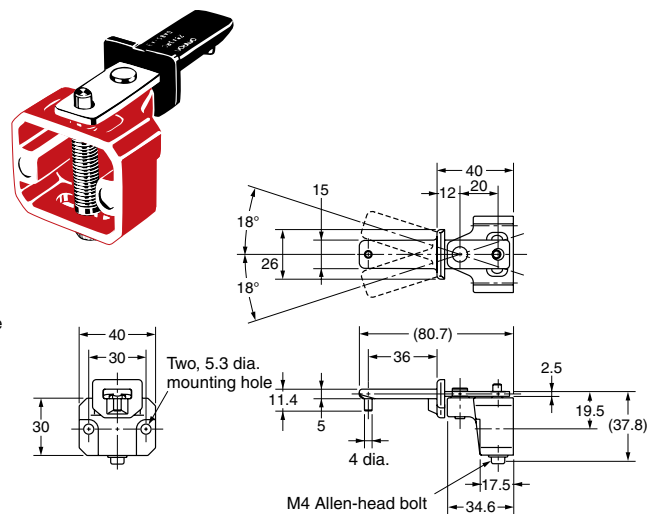

D4BS-K2

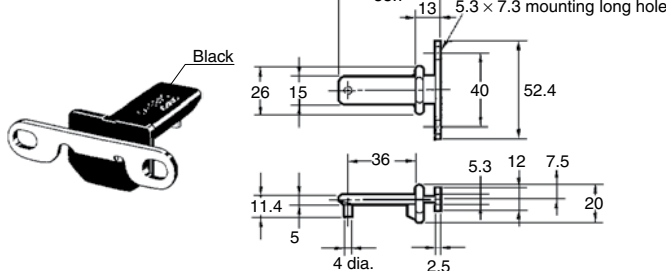

Note: Unless otherwise specified, a tolerance of ±0.4 mm applies to all dimensions.

Ordering

Model Number Structure

Switch

D4BS – □ □ □ S

① ② ③

- ① Conduit Size
 - 1: Pg13.5 (1-conduit)
 - 2: G1/2 (1-conduit)
 - 3: 1/2-14NPT (1-conduit)
 - 4: M20 (1-conduit)
 - 5: PG13.5 (3-conduit)
 - 6: G1/2 (3-conduit)
 - 7: 1/2-14 NPT (3-conduit)
 - 8: M20 (2-conduit)
- ② Built-in Switch
 - 5: 1NC/1NO (slow-action)
 - 6: 1NC/1NO (slow-action), gold-plated contacts
 - A: 2NC (slow-action)
 - B: 2NC (slow-action), gold-plated contacts
- ③ Head Mounting Direction
 - F: Four mounting directions possible (Front-side mounting at shipping)



Note: An order for the head part or the switch part alone cannot be accepted. (The operation key is sold separately.)

Operation Key

D4BS-K □

①

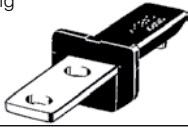

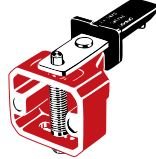
- ① Operation Key Type
 - 1: Horizontal mounting
 - 2: Vertical mounting
 - 3: Adjustable mounting (horizontal)

Type	Model
Horizontal mounting 	D4BS-K1
Vertical mounting 	D4BS-K2
Adjustable mounting (horizontal) 	D4BS-K3

G

List of Models

Switches (Operation Keys are sold separately)

Type	Mounting direction		Conduit size	1NC/1NO (Slow-action)	2NC (Slow-action)
1-conduit	Front-side mounting		Pg13.5	D4BS-15FS	D4BS-1AFS
			G1/2	D4BS-25FS	D4BS-2AFS
			1/2-14NPT	D4BS-35FS	D4BS-3AFS
			M20	D4BS-45FS	D4BS-4AFS
3-conduit	Front-side mounting		Pg13.5	D4BS-55FS	D4BS-5AFS
			G1/2	D4BS-65FS	D4BS-6AFS
			1/2-14NPT	D4BS-75FS	D4BS-7AFS
			M20	D4BS-85FS	D4BS-8AFS

 = Highlighted **Rapid Delivery** products are available for shipment today or within **FIVE** days.