

2 Form A Solid State Relay

Features

- Current Limit Protection
 - Isolation Test Voltage 5300 V_{RMS}
 - Typical R_{ON} 20 Ω
 - Load Voltage 350 V
 - Load Current 110 mA
 - High Surge Capability
 - Clean Bounce Free Switching
 - Low Power Consumption
 - High Reliability Monolithic Receptor
 - SMD Lead Available on Tape and Reel
-
- Lead-free component
 - Component in accordance to RoHS 2002/95/EC and WEEE 2002/96/EC

Agency Approvals

- UL1577, File No. E52744 System Code H or J, Double Protection
- CSA - Certification 093751
- DIN EN 60747-5-2 (VDE0884)
DIN EN 60747-5-5 pending

Applications

General Telecom Switching

- On/off Hook Control
- Ring Delay
- Dial Pulse
- Ground Start
- Ground Fault Protection

Instrumentation

Industrial Controls

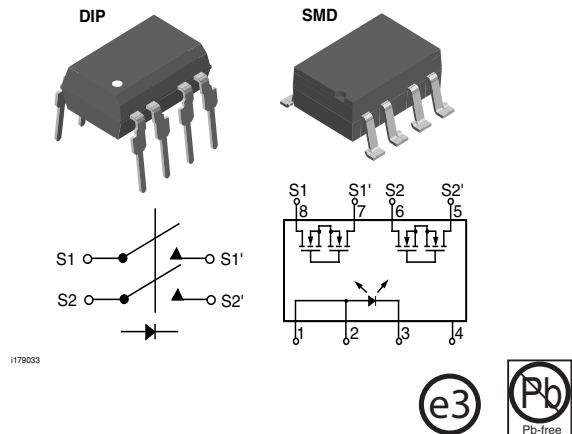

Description

The LH1503 relays are DPST normally open switches (2 Form A) that can replace electromechanical relays in many applications. The relays are constructed using a GaAlAs LED for actuation control and an integrated monolithic die for the switch output. The die, fabricated in a high-voltage dielectrically isolated technology, is comprised of a photodiode array, switch control circuitry, and DMOS switches. In addition, these relays employ current-limiting circuitry, enabling them to pass FCC 68.302 and other regulatory voltage surge requirements when overvoltage protection is provided.

Order Information

Part	Remarks
LH1503AAC	Tubes, SMD-8
LH1503AACTR	Tape and Reel, SMD-8
LH1503AB	Tubes, DIP-8

Absolute Maximum Ratings, $T_{amb} = 25\text{ }^{\circ}\text{C}$

Stresses in excess of the absolute Maximum Ratings can cause permanent damage to the device. Functional operation of the device is not implied at these or any other conditions in excess of those given in the operational sections of this document. Exposure to absolute Maximum Ratings for extended periods of time can adversely affect reliability.

SSR

Parameter	Test condition	Symbol	Value	Unit
LED continuous forward current		I_F	50	mA
LED reverse voltage	$I_R \leq 10\text{ }\mu\text{A}$	V_R	8.0	V
DC or peak AC load voltage	$I_L \leq 50\text{ }\mu\text{A}$	V_L	200	V
Continuous DC load current one pole operating		I_L	150	mA
Continuous DC load current two poles operating		I_L	110	mA
Peak load current (single shot)	$t = 100\text{ ms}$	I_P	1)	
Ambient temperature range		T_{amb}	- 40 to + 85	$^{\circ}\text{C}$
Storage temperature range		T_{stg}	- 40 to + 150	$^{\circ}\text{C}$
Pin soldering temperature	$t = 10\text{ s max}$	T_{sld}	260	$^{\circ}\text{C}$
Input/output isolation voltage		V_{ISO}	5300	V_{RMS}
Pole-to-pole isolation voltage (S1 to S2)			500	V
Output power dissipation (continuous)		P_{diss}	600	mW

1) Refer to Current Limit Performance Application Note for a discussion on relay operation during transient currents.

Electrical Characteristics, $T_{amb} = 25\text{ }^{\circ}\text{C}$

Minimum and maximum values are testing requirements. Typical values are characteristics of the device and are the result of engineering evaluations. Typical values are for information only and are not part of the testing requirements.

Input

Parameter	Test condition	Symbol	Min	Typ.	Max	Unit
LED forward current, switch turn-on	$I_L = 100\text{ mA}$, $t = 10\text{ ms}$	I_{Fon}		2.0	3.0	mA
LED forward current, switch turn-off	$V_L = \pm 300\text{ V}$	I_{Foff}	0.2	0.8		mA
LED forward voltage	$I_F = 10\text{ mA}$	V_F	1.15	1.26	1.45	V

Output

Parameter	Test condition	Symbol	Min	Typ.	Max	Unit
ON-resistance	$I_F = 5.0\text{ mA}$, $I_L = 50\text{ mA}$	R_{ON}	12	20	25	Ω
Pole-to-pole ON-resistance matching (S1 to S2)	$I_F = 5.0\text{ mA}$, $I_L = 50\text{ mA}$			0.2	2.0	$\Delta\Omega$
OFF-resistance	$I_F = 0\text{ mA}$, $V_L = \pm 100\text{ V}$	R_{OFF}	0.5	5000		$G\Omega$
Current limit	$I_F = 5.0\text{ mA}$, $t = 5.0\text{ ms}$, $V_L = \pm 6.0\text{ V}$	I_{LMT}	230	270	370	mA
Off-state leakage current	$I_F = 0\text{ mA}$, $V_L = \pm 100\text{ V}$	I_O		0.02	200	nA
	$I_F = 0\text{ mA}$, $V_L = \pm 350\text{ V}$	I_O			1.0	μA
Output capacitance	$I_F = 0\text{ mA}$, $V_L = 1.0\text{ V}$	C_O		55		pF
	$I_F = 0\text{ mA}$, $V_L = 50\text{ V}$	C_O		10		pF

Parameter	Test condition	Symbol	Min	Typ.	Max	Unit
Pole-to-pole capacitance (S1 to S2)	$I_F = 0 \text{ mA}$			3.0		pF
	$I_F = 5.0 \text{ mA}$			4.0		pF
Switch offset	$I_F = 5.0 \text{ mA}$	V_{OS}		0.15		V

Transfer

Parameter	Test condition	Symbol	Min	Typ.	Max	Unit
Capacitance (input-output)	V_{ISO}	C_{ISO}		1.1		pF
Turn-on time	$I_F = 10.0 \text{ mA}, I_L = 50 \text{ mA}$	t_{on}		1.6	2.5	ms
Turn-off time	$I_F = 10.0 \text{ mA}, I_L = 50 \text{ mA}$	t_{off}		0.65	2.5	ms

Typical Characteristics ($T_{amb} = 25 \text{ }^\circ\text{C}$ unless otherwise specified)

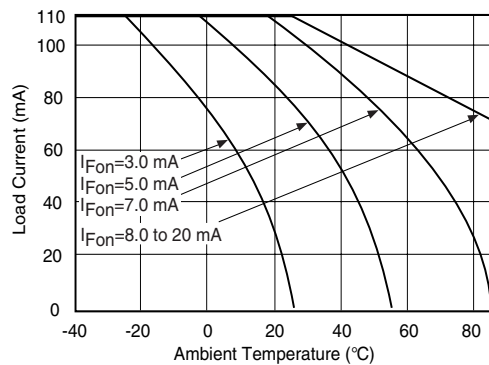

ih1503ab_00

Figure 1. Recommended Operating Conditions

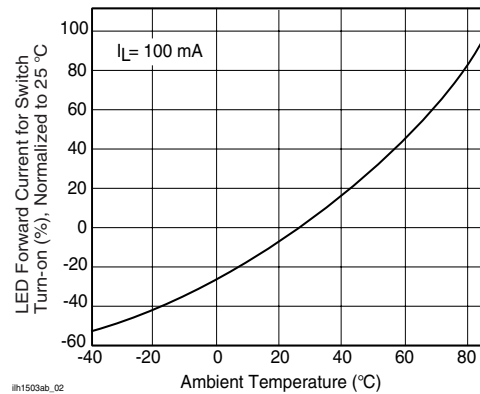

ih1503ab_02

Figure 3. LED Current for Switch Turn-on vs. Temperature

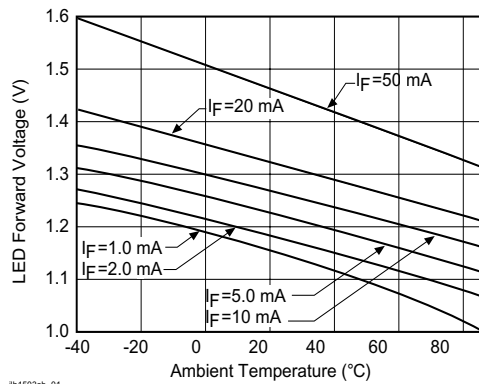

ih1503ab_01

Figure 2. LED Voltage vs. Temperature

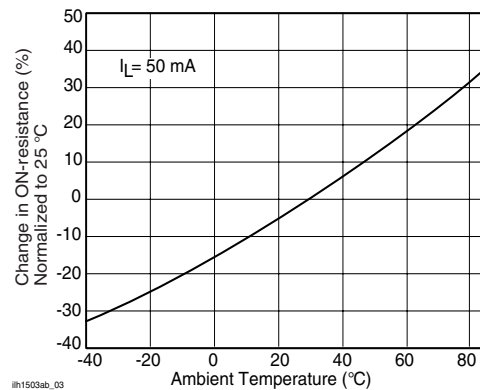

ih1503ab_03

Figure 4. ON-Resistance vs. Temperature

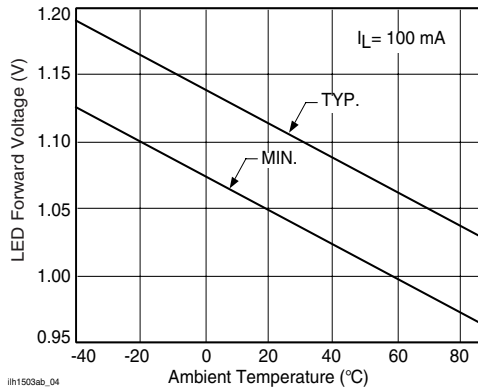

lh1503ab_04

Figure 5. LED Dropout Voltage vs. Temperature

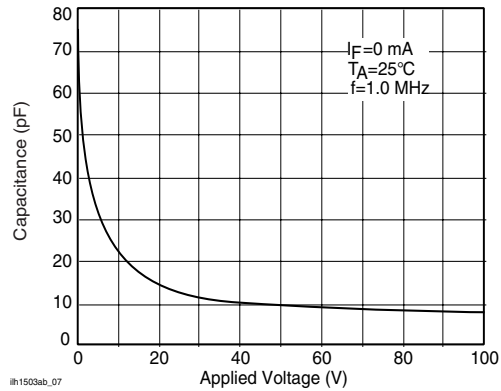

lh1503ab_07

Figure 8. Switch Capacitance vs. Applied Voltage

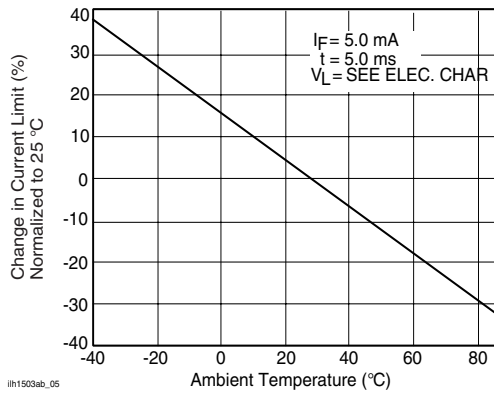

lh1503ab_05

Figure 6. Current Limit vs. Temperature

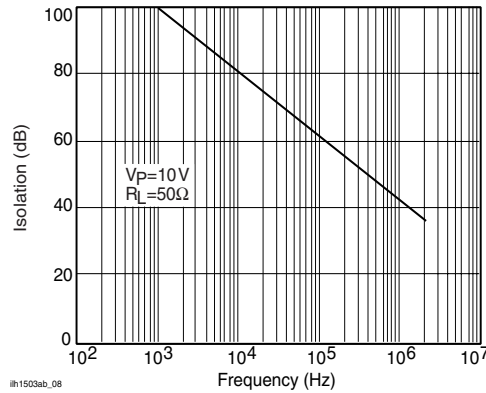

lh1503ab_08

Figure 9. Output Isolation

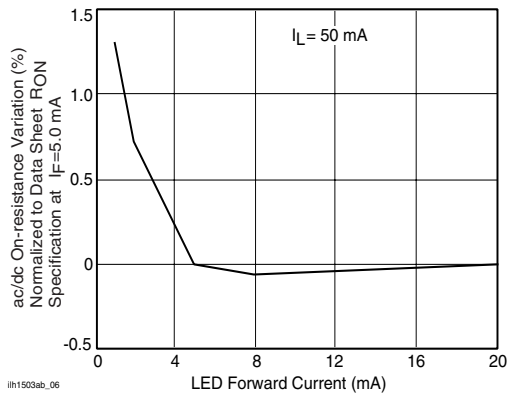

lh1503ab_06

Figure 7. Variation in ON-Resistance vs. LED Current

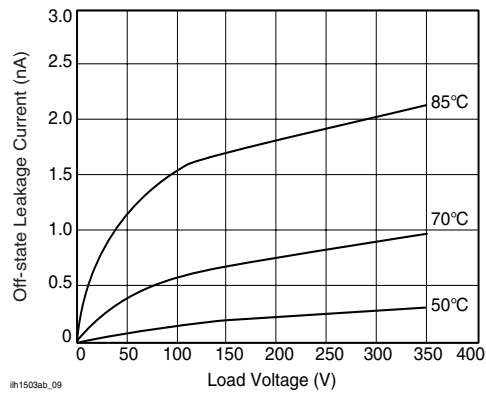

lh1503ab_09

Figure 10. Leakage Current vs. Applied Voltage at Elevated Temperatures

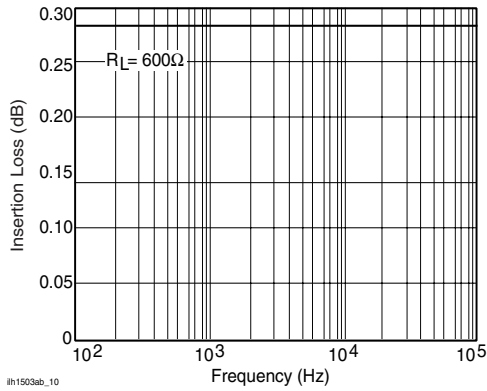

Figure 11. Insertion Loss vs. Frequency

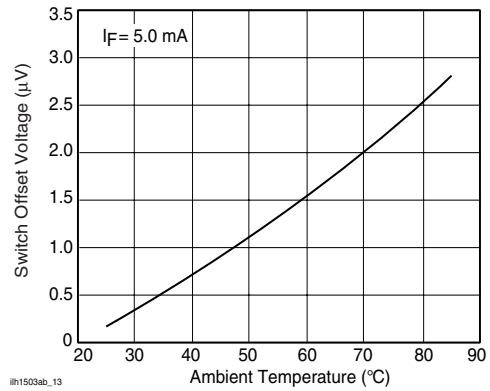

Figure 14. Switch Offset Voltage vs. Temperature

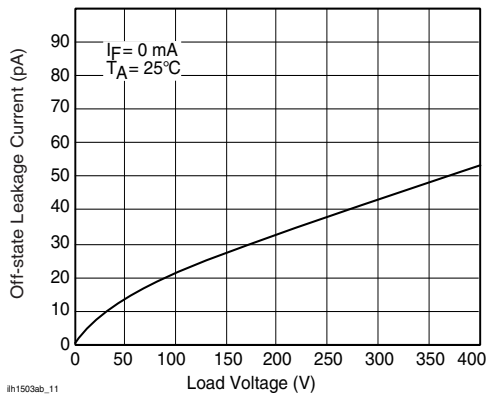

Figure 12. Leakage Current vs. Applied Voltage

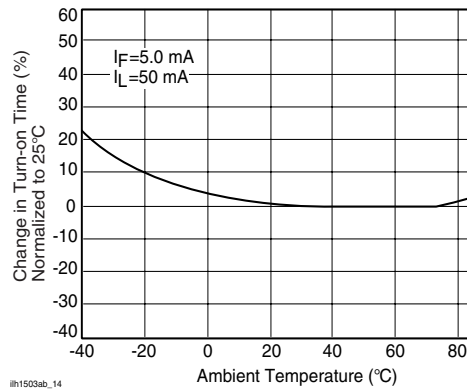

Figure 15. Turn-on Time vs. Temperature

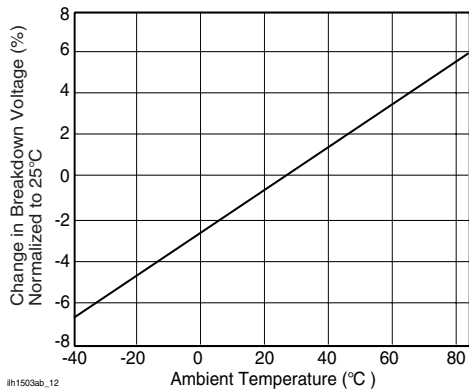

Figure 13. Switch Breakdown Voltage vs. Temperature

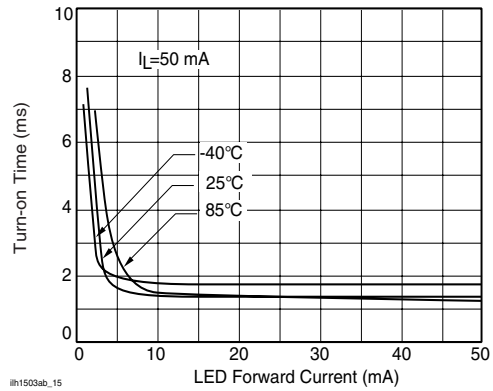

Figure 16. Turn-on Time vs. LED Current

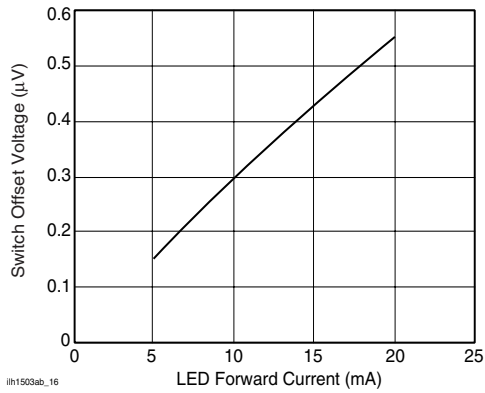

Figure 17. Switch Offset Voltage vs. LED Current

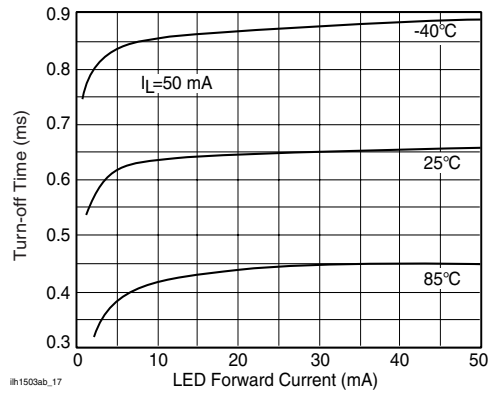
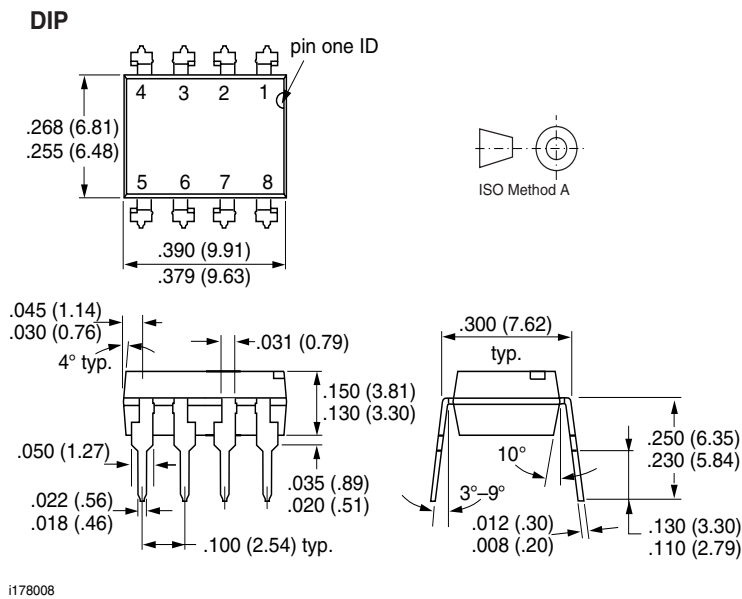

Figure 18. Turn-off Time vs. Temperature

Package Dimensions in Inches (mm)



i178008

Package Dimensions in Inches (mm)

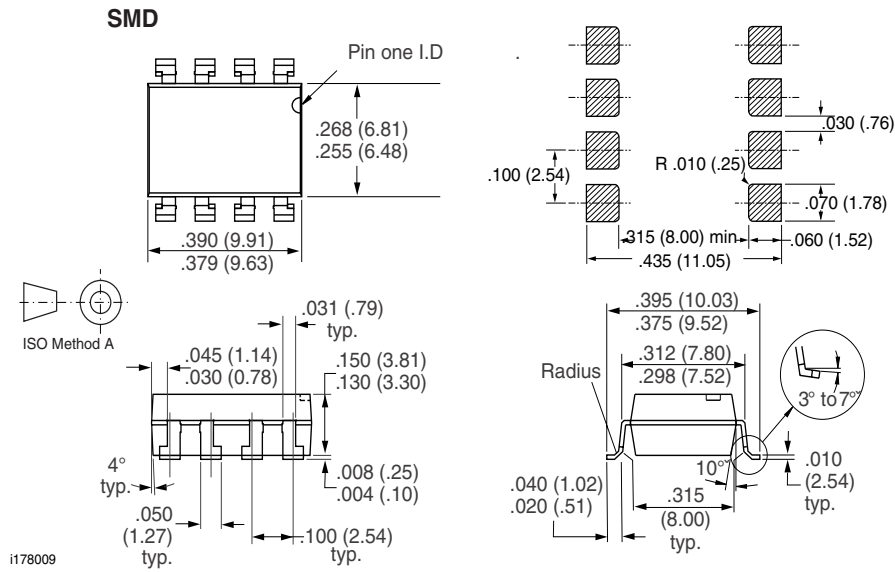

Ozone Depleting Substances Policy Statement

It is the policy of Vishay Semiconductor GmbH to

1. Meet all present and future national and international statutory requirements.
2. Regularly and continuously improve the performance of our products, processes, distribution and operating systems with respect to their impact on the health and safety of our employees and the public, as well as their impact on the environment.

It is particular concern to control or eliminate releases of those substances into the atmosphere which are known as ozone depleting substances (ODSs).

The Montreal Protocol (1987) and its London Amendments (1990) intend to severely restrict the use of ODSs and forbid their use within the next ten years. Various national and international initiatives are pressing for an earlier ban on these substances.

Vishay Semiconductor GmbH has been able to use its policy of continuous improvements to eliminate the use of ODSs listed in the following documents.

1. Annex A, B and list of transitional substances of the Montreal Protocol and the London Amendments respectively
2. Class I and II ozone depleting substances in the Clean Air Act Amendments of 1990 by the Environmental Protection Agency (EPA) in the USA
3. Council Decision 88/540/EEC and 91/690/EEC Annex A, B and C (transitional substances) respectively.

Vishay Semiconductor GmbH can certify that our semiconductors are not manufactured with ozone depleting substances and do not contain such substances.

We reserve the right to make changes to improve technical design and may do so without further notice.

Parameters can vary in different applications. All operating parameters must be validated for each customer application by the customer. Should the buyer use Vishay Semiconductors products for any unintended or unauthorized application, the buyer shall indemnify Vishay Semiconductors against all claims, costs, damages, and expenses, arising out of, directly or indirectly, any claim of personal damage, injury or death associated with such unintended or unauthorized use.

Vishay Semiconductor GmbH, P.O.B. 3535, D-74025 Heilbronn, Germany
Telephone: 49 (0)7131 67 2831, Fax number: 49 (0)7131 67 2423



Disclaimer

All product specifications and data are subject to change without notice.

Vishay Intertechnology, Inc., its affiliates, agents, and employees, and all persons acting on its or their behalf (collectively, "Vishay"), disclaim any and all liability for any errors, inaccuracies or incompleteness contained herein or in any other disclosure relating to any product.

Vishay disclaims any and all liability arising out of the use or application of any product described herein or of any information provided herein to the maximum extent permitted by law. The product specifications do not expand or otherwise modify Vishay's terms and conditions of purchase, including but not limited to the warranty expressed therein, which apply to these products.

No license, express or implied, by estoppel or otherwise, to any intellectual property rights is granted by this document or by any conduct of Vishay.

The products shown herein are not designed for use in medical, life-saving, or life-sustaining applications unless otherwise expressly indicated. Customers using or selling Vishay products not expressly indicated for use in such applications do so entirely at their own risk and agree to fully indemnify Vishay for any damages arising or resulting from such use or sale. Please contact authorized Vishay personnel to obtain written terms and conditions regarding products designed for such applications.

Product names and markings noted herein may be trademarks of their respective owners.