

Telecom Switch 1 Form A Solid State Relay

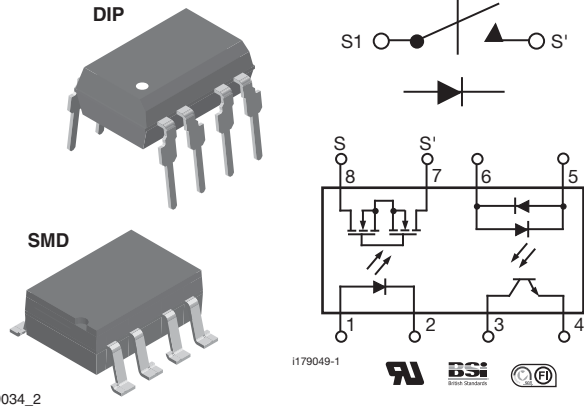

1179034_2

DESCRIPTION

The LH1529A and LH1529B telecom switches consist of an optically coupled solid state relay (SSR) and bidirectional input optocoupler. The SSR is ideal for performing switch hook and dial-pulse switching whilst optocoupler performs ring detection and loop current sensing functions. Both the SSR and optocoupler have an isolation test voltage of 5300 V_{RMS}.

AGENCY APPROVALS

UL1577: file no. E52744 system code H, double protection

BSI/BABT: certification no. 7980

FIMKO: approval

FEATURES

- Solid state relay and optocoupler in one package
- Surface mount package
- I/O isolation, 5300 V_{RMS}
- LH1529A, CTR Min. = 33 %
- LH1529B, CTR Min. = 100 %
- Optocoupler
 - Bidirectional current detection
- Solid-state relay (equivalent to TS117P)
 - Typical R_{ON} 20 Ω
 - Load voltage 350 V
 - Load current 120 mA
 - Current limit protection
 - High surge capability
 - Clean bounce free switching
 - Low power consumption
 - High reliability monolithic receptor
- Compliant to RoHS Directive 2002/95/EC and in accordance to WEEE 2002/96/EC



RoHS
COMPLIANT

APPLICATIONS

- General telecom switching
 - On/off hook control
 - Dial pulse
 - Ring current detection
 - Loop current sensing

Note

- See "solid state relays" (application note 56)

ORDERING INFORMATION

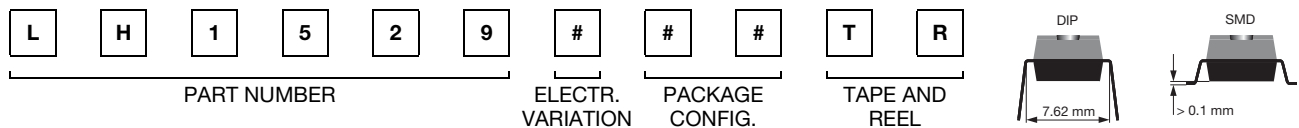

PACKAGE	UL, BSI, FIMKO
SMD-8, tubes	LH1529AAC
SMD-8, tape and reel	LH1529AACTR
DIP-8, tubes	LH1529AB
SMD-8, tubes	LH1529BAC
SMD-8, tape and reel	LH1529BACTR
DIP-8, tubes	LH1529BB

LH1529AB, LH1529AAC, LH1529AACTR, LH1529BB,



Vishay Semiconductors Telecom Switch 1 Form A Solid State Relay

ABSOLUTE MAXIMUM RATINGS ($T_{amb} = 25\text{ }^{\circ}\text{C}$, unless otherwise specified)				
PARAMETER	TEST CONDITION	SYMBOL	VALUE	UNIT
SSR				
INPUT				
LED continuous forward current		I_F	50	mA
LED reverse voltage	$I_R \leq 10\text{ }\mu\text{A}$	V_R	5	V
OUTPUT				
DC or peak AC load voltage	$I_L \leq 50\text{ }\mu\text{A}$	V_L	350	V
Continuous DC load current		I_L	120	mA
SSR				
Total power dissipation		P_{diss}	600	mW
Ambient temperature range		T_{amb}	- 40 to + 85	$^{\circ}\text{C}$
Storage temperature range		T_{stg}	- 40 to + 150	$^{\circ}\text{C}$
Soldering temperature ⁽¹⁾	$t = 10\text{ s max.}$	T_{sld}	260	$^{\circ}\text{C}$
Isolation test voltage (for 1 s)		V_{ISO}	5300	V_{RMS}
Isolation resistance	$V_{IO} = 500\text{ V}, T_{amb} = 25\text{ }^{\circ}\text{C}$	R_{IO}	$\geq 10^{12}$	Ω
	$V_{IO} = 500\text{ V}, T_{amb} = 100\text{ }^{\circ}\text{C}$	R_{IO}	$\geq 10^{11}$	Ω
OPTOCOUPLER				
INPUT				
LED continuous forward current		I_F	50	mA
LED reverse voltage	$I_R \leq 10\text{ }\mu\text{A}$	V_R	5	V
OUTPUT				
Collector emitter breakdown voltage		BV_{CEO}	30	V
Phototransistor power dissipation		P_{diss}	150	mW

Notes

- Stresses in excess of the absolute maximum ratings can cause permanent damage to the device. Functional operation of the device is not implied at these or any other conditions in excess of those given in the operational sections of this document. Exposure to absolute maximum ratings for extended periods of the time can adversely affect reliability.

⁽¹⁾ Refer to reflow profile for soldering conditions for surface mounted devices (SMD). Refer to wave profile for soldering conditions for through hole devices (DIP).

ELECTRICAL CHARACTERISTICS ($T_{amb} = 25\text{ }^{\circ}\text{C}$, unless otherwise specified)							
PARAMETER	TEST CONDITION	PART	SYMBOL	MIN.	TYP.	MAX.	UNIT
SSR							
INPUT							
LED forward current switch turn-on	$I_L = 100\text{ mA}, t = 10\text{ ms}$		I_{Fon}		0.7	2	mA
LED forward current switch turn-off	$V_L = \pm 300\text{ V}$		I_{Foff}	0.2	0.6		mA
LED forward voltage	$I_F = 10\text{ mA}$		V_F	1.15	1.26	1.45	V
OUTPUT							
On-resistance AC/DC, pins 4 (\pm) to 6 (\pm)	$I_F = 5\text{ mA}, I_L = \pm 50\text{ mA}$		R_{ON}	12	20	25	Ω
Current limit	$I_F = 5\text{ mA}, t = 5\text{ ms}, V_L = \pm 6\text{ V}$	LH1529AB	I_{limit}	230	260	370	mA
		LH1529AAC	I_{limit}	230	260	370	mA
		LH1529BB	I_{limit}	170	210	250	mA
		LH1529BAC	I_{limit}	170	210	250	mA
Off-state leakage current	$I_F = 0\text{ mA}, V_L = \pm 100\text{ V}$		I_O		0.02	200	nA
	$I_F = 0\text{ mA}, V_L = \pm 350\text{ V}$		I_O			1	μA
Output capacitance pin 7 to pin 8	$I_F = 0\text{ mA}, V_L = 1\text{ V}$		C_O		55		pF
	$I_F = 0\text{ mA}, V_L = 50\text{ V}$		C_O		10		pF
Capacitance (input to output)	$V_{ISO} = 1\text{ V}$		C_{IO}		1.3		pF



LH1529AB, LH1529AAC, LH1529AACTR, LH1529BB,

Telecom Switch 1 Form A Solid State Vishay Semiconductors Relay

ELECTRICAL CHARACTERISTICS ($T_{amb} = 25\text{ }^{\circ}\text{C}$, unless otherwise specified)							
PARAMETER	TEST CONDITION	PART	SYMBOL	MIN.	TYP.	MAX.	UNIT
OPTOCOUPLER							
LED forward current	$I_F = 10\text{ mA}$		V_F	0.9	1.2	1.5	V
Saturation voltage	$I_F = 16\text{ mA}, I_C = 2\text{ mA}$		V_{CEsat}		0.7	0.5	V
Collector emitter dark current	$I_F = 0\text{ mA}, V_{CE} = 5\text{ V}$		I_{CEO}			500	nA
Trickle current leakage	$I_F = 5\text{ }\mu\text{A}, V_{CE} = 5\text{ V}$		I_{CEO}			1	μA
DC current transfer ratio	$I_F = 6\text{ mA}, V_{CE} = 0.5\text{ V}$	LH1529AB	CTR_{DC}	33	100		%
		LH1529AAC	CTR_{DC}	33	100		%
		LH1529BB	CTR_{DC}	100	165		%
		LH1529BAC	CTR_{DC}	100	165		%

Note

- Minimum and maximum values are testing requirements. Typical values are characteristics of the device and are the result of engineering evaluations. Typical values are for information only and are not part of the testing requirements.

SWITCHING CHARACTERISTICS ($T_{amb} = 25\text{ }^{\circ}\text{C}$, unless otherwise specified)							
PARAMETER	TEST CONDITION	PART	SYMBOL	MIN.	TYP.	MAX.	UNIT
Turn-on time	$I_F = 5\text{ mA}, I_L = 50\text{ mA}$	LH1529AB	t_{on}		2	3	ms
		LH1529AAC	t_{on}		2	3	ms
		LH1529BB	t_{on}		1.3	2.5	ms
		LH1529BAC	t_{on}		1.3	2.5	ms
Turn-off time	$I_F = 5\text{ mA}, I_L = 50\text{ mA}$	LH1529AB	t_{off}		0.6	3	ms
		LH1529AAC	t_{off}		0.6	3	ms
		LH1529BB	t_{off}		0.6	2.5	ms
		LH1529BAC	t_{off}		0.6	2.5	ms

TYPICAL CHARACTERISTICS ($T_{amb} = 25\text{ }^{\circ}\text{C}$, unless otherwise specified)

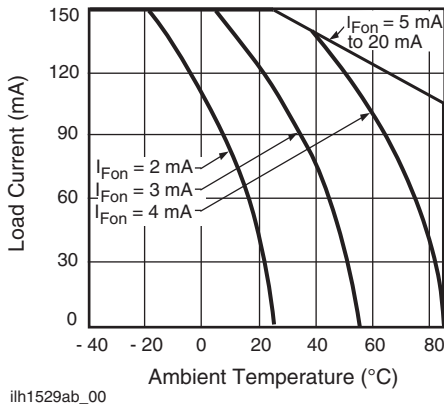

Fig. 1 - Recommended Operating Conditions

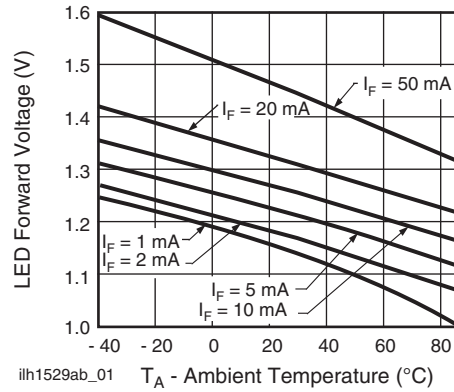

Fig. 2 - LED Voltage vs. Temperature

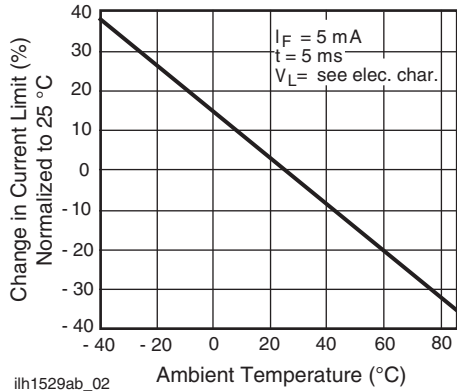

Fig. 3 - Current Limit vs. Temperature

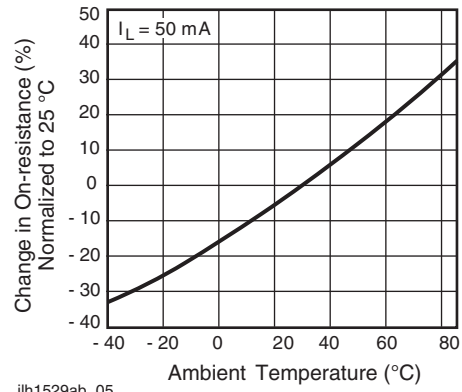

Fig. 6 - On-Resistance vs. Temperature

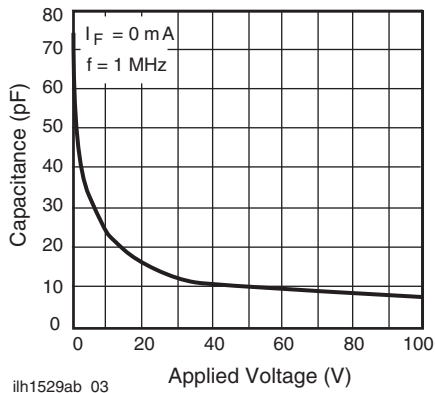

Fig. 4 - Switch Capacitance vs. Applied Voltage

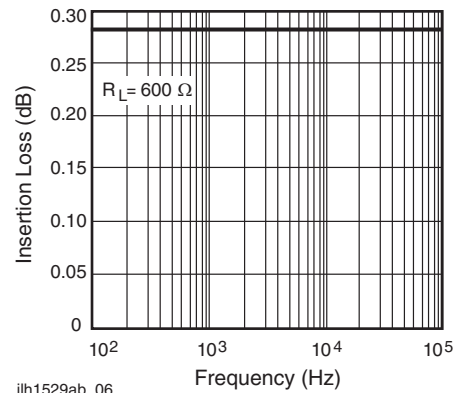

Fig. 7 - Insertion Loss vs. Frequency

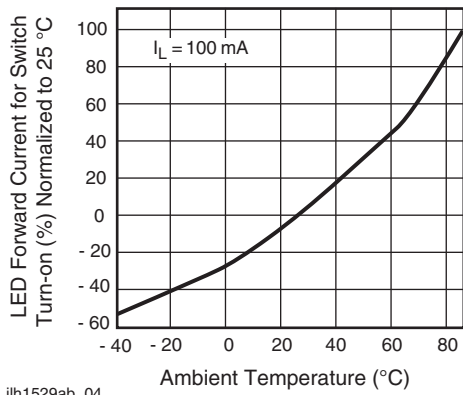

Fig. 5 - LED Current for Switch Turn-on vs. Temperature

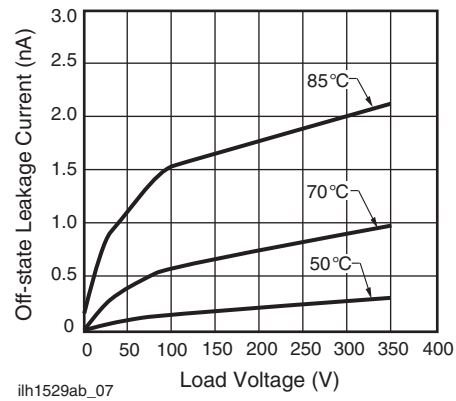

Fig. 8 - Leakage Current vs. Applied Voltage at Elevated Temperatures



LH1529AB, LH1529AAC, LH1529AACTR, LH1529BB,

Telecom Switch 1 Form A Solid State Vishay Semiconductors Relay

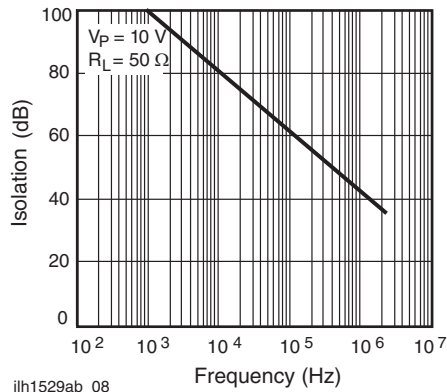

Fig. 9 - Output Isolation

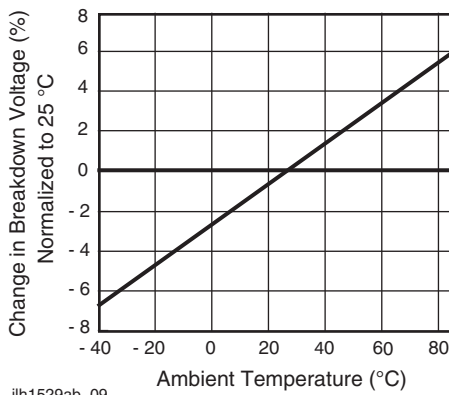

Fig. 10 - Switch Breakdown Voltage vs. Temperature

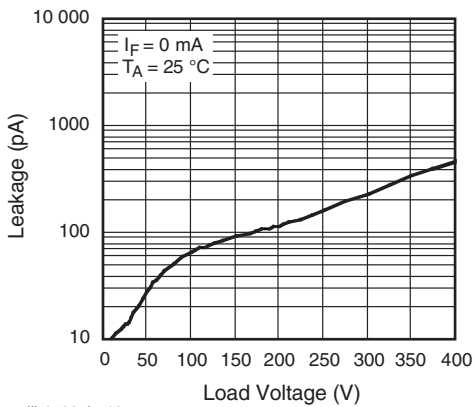

Fig. 11 - Leakage Current vs. Applied Voltage

LH1529AB, LH1529AAC, LH1529AACTR, LH1529BB,



Vishay Semiconductors Telecom Switch 1 Form A Solid State Relay

PACKAGE DIMENSIONS in millimeters

DIP

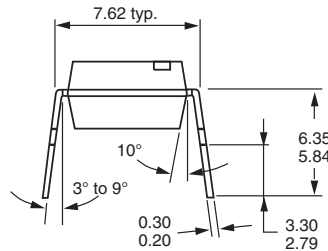
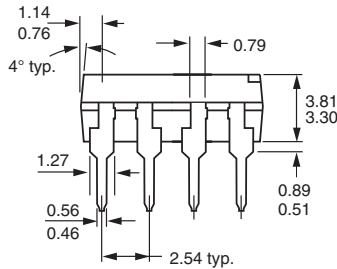
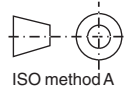
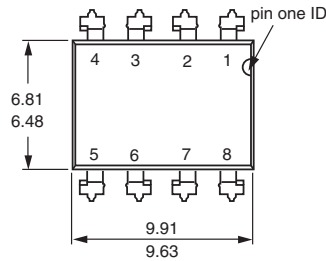

i178008

SMD

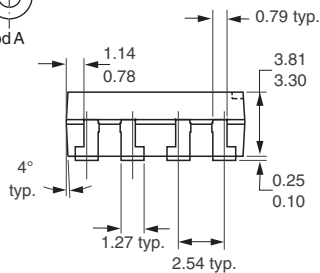
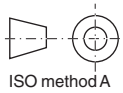
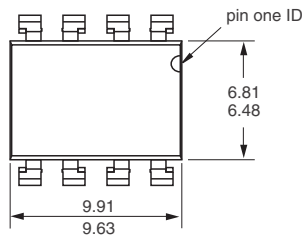

i178009

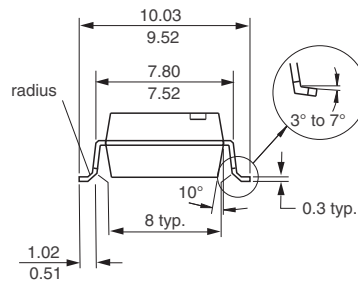
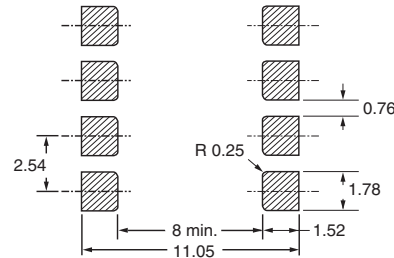

PACKAGE MARKING (example)

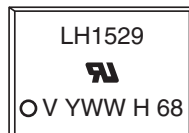

Note

- Tape and reel suffix (TR) is not part of the package marking.



Disclaimer

ALL PRODUCT, PRODUCT SPECIFICATIONS AND DATA ARE SUBJECT TO CHANGE WITHOUT NOTICE TO IMPROVE RELIABILITY, FUNCTION OR DESIGN OR OTHERWISE.

Vishay Intertechnology, Inc., its affiliates, agents, and employees, and all persons acting on its or their behalf (collectively, "Vishay"), disclaim any and all liability for any errors, inaccuracies or incompleteness contained in any datasheet or in any other disclosure relating to any product.

Vishay makes no warranty, representation or guarantee regarding the suitability of the products for any particular purpose or the continuing production of any product. To the maximum extent permitted by applicable law, Vishay disclaims (i) any and all liability arising out of the application or use of any product, (ii) any and all liability, including without limitation special, consequential or incidental damages, and (iii) any and all implied warranties, including warranties of fitness for particular purpose, non-infringement and merchantability.

Statements regarding the suitability of products for certain types of applications are based on Vishay's knowledge of typical requirements that are often placed on Vishay products in generic applications. Such statements are not binding statements about the suitability of products for a particular application. It is the customer's responsibility to validate that a particular product with the properties described in the product specification is suitable for use in a particular application. Parameters provided in datasheets and/or specifications may vary in different applications and performance may vary over time. All operating parameters, including typical parameters, must be validated for each customer application by the customer's technical experts. Product specifications do not expand or otherwise modify Vishay's terms and conditions of purchase, including but not limited to the warranty expressed therein.

Except as expressly indicated in writing, Vishay products are not designed for use in medical, life-saving, or life-sustaining applications or for any other application in which the failure of the Vishay product could result in personal injury or death. Customers using or selling Vishay products not expressly indicated for use in such applications do so at their own risk and agree to fully indemnify and hold Vishay and its distributors harmless from and against any and all claims, liabilities, expenses and damages arising or resulting in connection with such use or sale, including attorneys fees, even if such claim alleges that Vishay or its distributor was negligent regarding the design or manufacture of the part. Please contact authorized Vishay personnel to obtain written terms and conditions regarding products designed for such applications.

No license, express or implied, by estoppel or otherwise, to any intellectual property rights is granted by this document or by any conduct of Vishay. Product names and markings noted herein may be trademarks of their respective owners.