

THIS DOCUMENT CONTAINS DATA PROPRIETARY TO PROJECTS UNLIMITED, INC. ANY USE OR REPRODUCTION, IN ANY FORM, WITHOUT PRIOR WRITTEN PERMISSION OF PROJECTS UNLIMITED, INC. IS PROHIBITED.
© 2003, Projects Unlimited Inc.

SPECIFICATIONS

PARAMETERS	VALUES	UNITS
DIRECTIVITY	OMNI	-
SENSITIVITY	-40±3	dB
STANDARD OPERATING VOLTAGE	1.5	Vdc
MAX OPERATING VOLTAGE	10	Vdc
CURRENT CONSUMPTION MAX	0.5	mA
IMPEDANCE	2.2	kOhm
SIGNAL TO NOISE RATIO	60	dB
TERMINAL	SOLDER PADS	-
INTERNAL CAPACITOR	N/A	pF

REVISIONS			
LTR	DESCRIPTION	DATE	APPROVED
-	RELEASED FROM ENGINEERING	12/29/03	
A	REVISED IMPEDANCE	5/13/04	R. W.
B	REVISED DIMENSION SIZE AND STYLE	02/14/06	B. R.

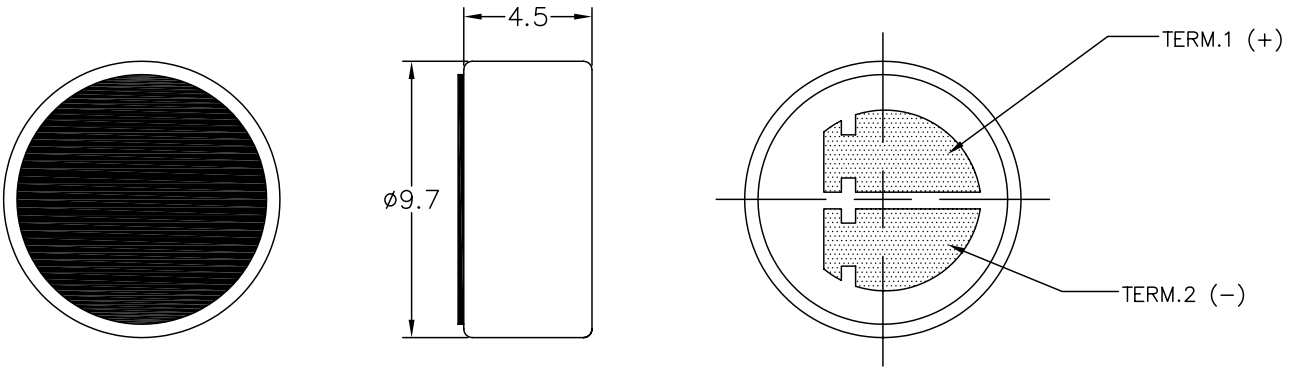

NOTES:

1. ALL DIMENSIONS ARE IN MILLIMETERS.
2. SPECIFICATION SUBJECT TO CHANGE OR WITHDRAWAL WITHOUT NOTICE.

FILE NAME
AOM-4540L.DWG

UNLESS OTHERWISE SPECIFIED: DIMENSIONS ARE IN MILLIMETERS, TOLERANCES ARE ±0.5 AND ANGLES ARE ±3°.		 projects® unlimited Dayton, Ohio							
<table border="1"> <thead> <tr> <th>APPROVALS</th> <th>DATE</th> </tr> </thead> <tbody> <tr> <td>DRAWN <i>R. A. O.</i></td> <td>12/03</td> </tr> <tr> <td>APPROVED <i>E. P.</i></td> <td>12/03</td> </tr> </tbody> </table>		APPROVALS	DATE	DRAWN <i>R. A. O.</i>	12/03	APPROVED <i>E. P.</i>	12/03	MICROPHONE	
APPROVALS	DATE								
DRAWN <i>R. A. O.</i>	12/03								
APPROVED <i>E. P.</i>	12/03								
DO NOT SCALE DRAWING		SIZE A	DRAWING NO. AOM-4540L						
		SCALE: N.T.S.	SHEET 1 OF 1						