

THIS DOCUMENT IS THE PROPERTY OF
KEYSTONE ELECTRONICS CORP. AND
SHALL NOT BE REPRODUCED, DISTRIBUTED
OR USED AS A BASIS FOR MANUFACTURE
WITHOUT PRIOR WRITTEN PERMISSION
FROM KEYSTONE ELECTRONICS CORP.

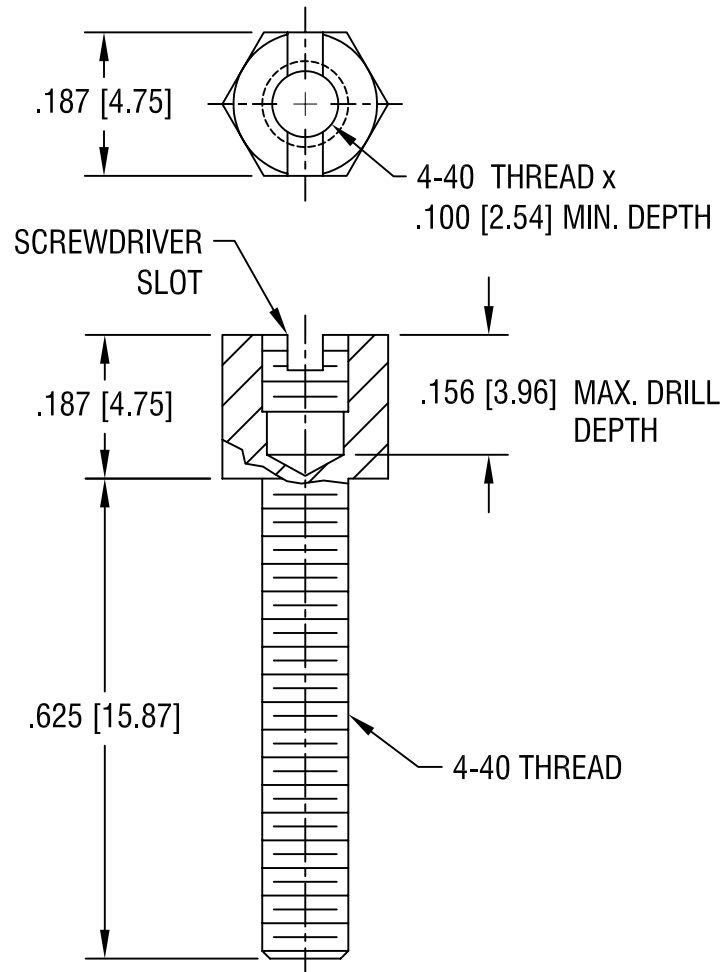

KEYSTONE ELECTRONICS CORP.			
ASTORIA, N.Y. 11105-2017			
PART NAME		JACK SCREW W/ SLOT	
MATERIAL		STEEL	
FINISH	ZINC PLATE CLEAR CHROMATE	DRN BY BOONE	DATE 3.10.06
		APP'D	SCALE 4X
TOLERANCES	INCH [MM]	CODE	DWG NO.
DECIMAL	$\pm .005$ [± 0.15]	C/M	7279
ANGULAR	$\pm 1^\circ$	UNLESS OTHERWISE SPECIFIED	

DATE	DESCRIPTION	REV.	