

PART No. 1441-18

for more information visit
www.hammondmfg.com

Data subject to change without notice

ISOMETRIC VIEW NOT TO SCALE

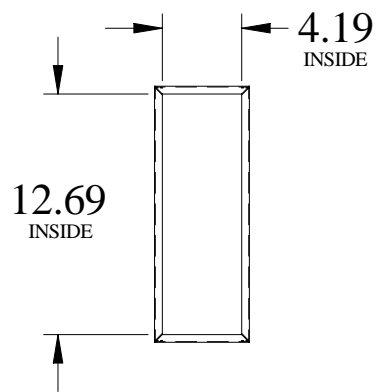

LID REMOVED FOR CLARITY

