

Current refinements (click  to remove)

[Search Tips](#) 
 Region  USA Product Family  Ring Terminal, Non-Insulated – High Temperature Text Search: 'P14-8RHT6-C'

Your search criteria matched only one product, shown below.

- Nickel plated copper for temperatures up to 650°F (343°C)
- Internal barrel serrations assure good wire contact and maximum tensile strength
- Brazed seam protects terminal barrel from splitting during the crimp process
- Barrel of terminal internally beveled to provide quick and easy wire insertion

‡UL and CSA approved tooling/product combinations.



Part Number:	P14-8RHT6-C
RoHS Compliance Status:	Compliant
Part Description:	High Temperature Ring Terminal, 16 – 14 AWG, #8 stud size, non-insulated.
Product Type:	Terminals
Length (In.):	.71
Width (In.):	.31
Angle:	straight
Clearance:	.25
Stock:	.03
Stud Size:	#8
Tool:	CT-100A, CT-200, CT-600-A, CT-1570, CT-2500
Wire Range:	18 – 14 AWG
Wire Range (mm ²):	1.0 - 2.5
Min. Order UOM:	PC
Min. Order Qty.:	100
BOM Qty. (# of Pkgs.)	
Add to My Catalog	

 Please [register](#) to utilize the 'Bill of Materials', 'Submit Quotes' and 'My Catalog' features.

THIS COPY IS PROVIDED ON A RESTRICTED BASIS AND IS NOT TO BE USED IN ANY WAY DETRIMENTAL TO THE INTERESTS OF PANDUIT CORP.

PANDUIT PART NUMBER	STUD SIZE	DIMENSIONS in.				
		A $\pm .020$	W $\pm .010$	C MIN.	M $\pm .020$	H $\pm .010$
P14-6RHT6	#6	.62 (15.75)	.25 (6.35)	.20 (5.08)	.50 (12.70)	.15 (3.81)
P14-8RHT6	#8	.71 (18.03)	.31 (7.87)	.25 (6.35)	.55 (13.97)	.17 (4.32)
P14-10RHT6	#10	.71 (18.03)	.31 (7.87)	.25 (6.35)	.55 (13.97)	.20 (5.08)

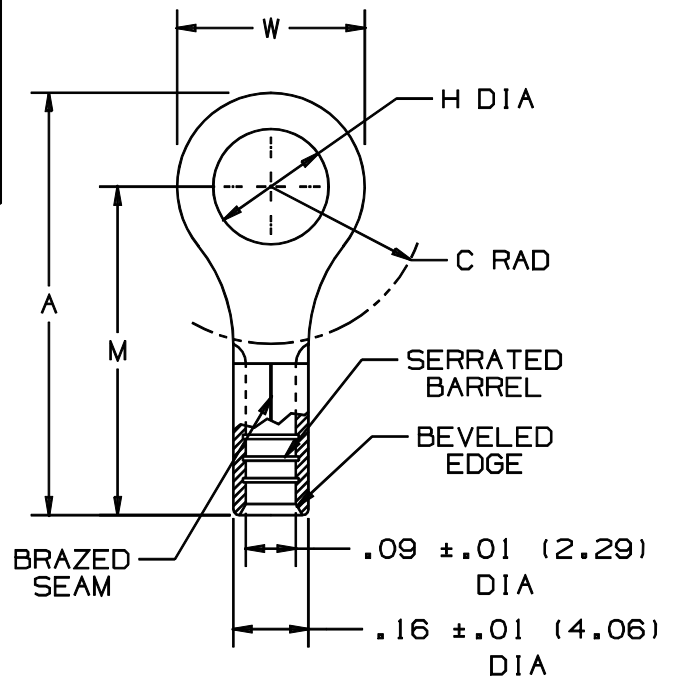

NOTES:

- RECOMMENDED FOR:
 - #18-14 AWG SOLID OR STRANDED COPPER WIRE
 - 650° F (343° C) MAX. TEMP. RATING
- MATERIAL:
 - STAMPING- .03" (.76) THK COPPER, NICKEL PLATED
- PACKAGE QTY:

STD. PKG.	-C=100
BULK PKG.	-M=1000
- DIMENSIONS IN BRACKETS ARE IN MILLIMETERS
- INSTALLATION TOOLS:
 - PANDUIT APPROVED: CT-100, CT-200, CT-160, CT-260, CT-570, CT-1570
- WIRE STRIP LENGTH: 9/32 $\pm 1/32$ (7.1 $\pm .8$)

A41266_05

05	1/01	RM		FILESPEC WAS N41266AA_PCD_04					TINLEY PARK, ILLINOIS		
04		JKD		ADDED CT-1570 TOOL	07632						
3	4-95	MS	RS	REVISED DIMENSIONS	03186	KS	LA	#16-14 BARREL NON-INSULATED RING TONGUE, HIGH TEMPERATURE, 650° F			
2	4-95	MS	RS	UPDATED NOTES AND DIMENSIONS	03166	KS	LA				
REV	DATE	BY	CHK	DESCRIPTION	ECN #	PM	APP	DRAWN BY DAW	CHK'D	SCALE NONE	DRAWING NO. A41266