

Tous droits strictement réservés. Reproduction ou communication à des tiers interdite sous quelque forme que ce soit sans autorisation écrite du propriétaire. Property of FCI. Droits de reproduction FCI.

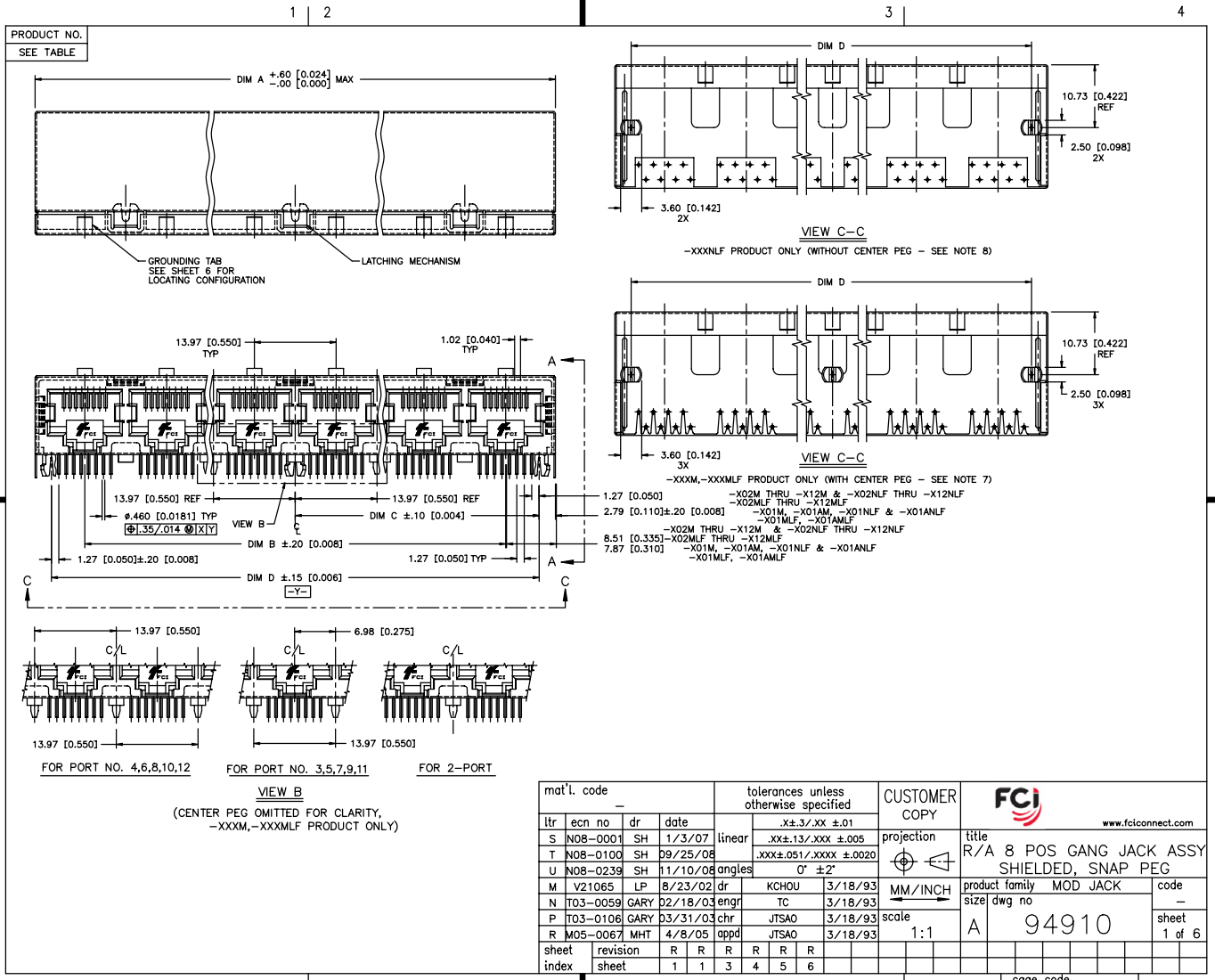

All rights strictly reserved. Reproduction or issue to third parties in any form whatever is not permitted without written authority from the proprietor. Property of FCI. Copyright FCI.



PRODUCT NO.  
SEE TABLE

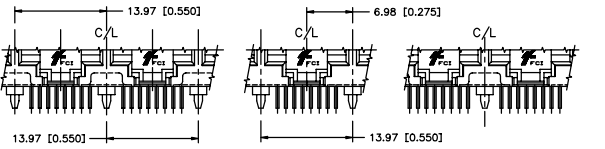
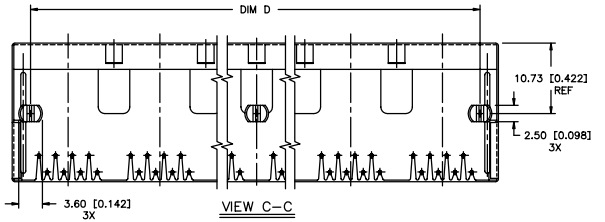
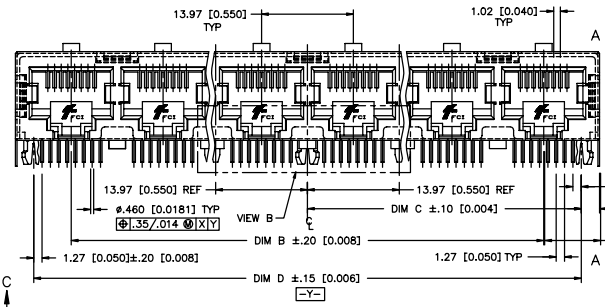
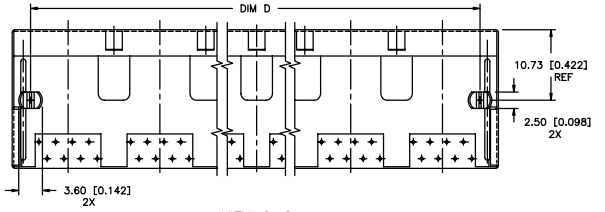
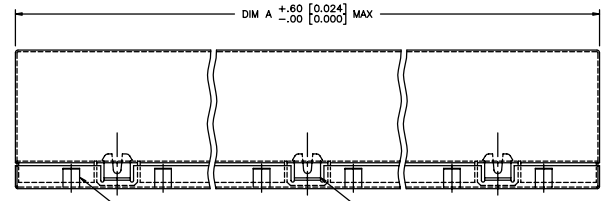

mat'l. code		tolerances unless otherwise specified		CUSTOMER COPY		FCI	
ltr	ecn no	dr	date	linear	projection	title	
S	N08-0001	SH	1/3/07	.X±.3/.XX ±.01		R/A 8 POS GANG JACK ASSY SHIELDED, SNAP PEG	
T	N08-0100	SH	09/25/08	.XX±.13/.XXX ±.005		product family MOD JACK code	
U	N08-0239	SH	11/10/08	.XXX±.051/.XXX ±.0020	MM/INCH	size dwg no	
M	V21065	LP	8/23/02	0° ±2°		94910	
N	T03-0059	GARY	02/18/03	KCHOU 3/18/93		sheet 1 of 6	
P	T03-0106	GARY	03/31/03	TC 3/18/93	cage code		
R	M05-0067	MHT	4/8/05	JTSAO 3/18/93	26		
sheet	revision	R	R	R	R	R	4
index	sheet	1	1	3	4	5	6

(CENTER PEG OMITTED FOR CLARITY, -XXXM, -XXXMLF PRODUCT ONLY)

ACAD

PDM: Rev:U

STATUS: Released 26 Printed: Aug 01, 2010

Tous droits strictement réservés. Reproduction ou communication à des tiers interdite sans quelque forme que ce soit sans autorisation écrite du propriétaire. Propriété de c FCI. Droits de reproduction FCI.



All rights strictly reserved. Reproduction or issue to third parties in any form whatever is not permitted without written authority from the proprietor. Property of FCI. Copyright FCI.

PRODUCT NO  
SEE TABLE

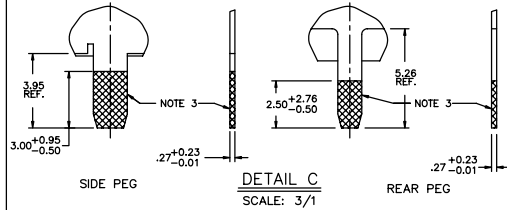
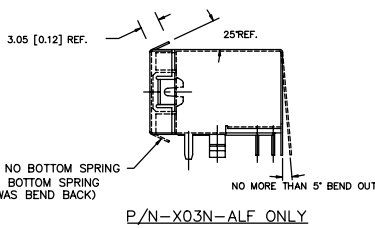
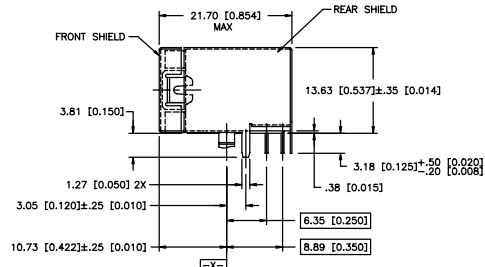
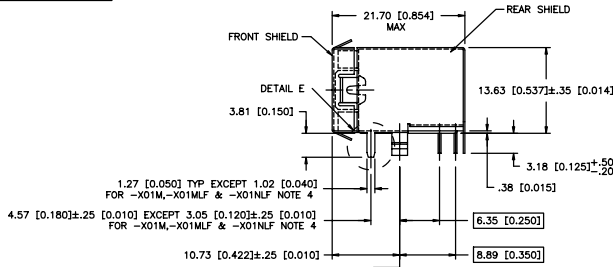

VIEW A-A

NOTE 5

NOTES:

1. RECOMMENDED P.C.B. THICKNESS 1.60 [0.063].
2. CONTACTS: PHOS BRONZE ALLOY UNS-C51000,  $\phi$  0.460 [0.0181] ROUND WIRE, PLATING SEE TABLE.
- ③ SHIELDING MAT'L: .25 [0.010] THICK BRASS ALLOY. SHIELDING PLATING: FOR 94910-XXXM: 2.54 $\mu$ m/100 $\mu$ m MIN BRIGHT TIN-LEAD PLATED OVER 0.76 $\mu$ m/30 $\mu$ m MIN NICKEL UNDERPLATING PER BUS-15-002/M. LEAD FREE OPTION: FOR 94910-XXXNLF: 0.76 $\mu$ m/30 $\mu$ m MIN NICKEL PLATING, WITH SELECTIVE TIN ON SOLDER TAILS, SEE DETAIL E. SHIELDING PLATING: FOR 94910-XXXMLF: 2.54 $\mu$ m/100 $\mu$ m MIN BRIGHT PURE TIN PLATED OVER 0.76 $\mu$ m/30 $\mu$ m MIN NICKEL UNDERPLATING PER BUS-15-002/M.
- ④ SPECIALLY FOR ONE-PORT P/N 94910-X01M,-X01MLF & 94910-X01NLF ONLY. SOLDER TAIL OF SHIELD IS 1.02 [0.040] WIDE, DISTANCE FROM PCB PEG TO THE SOLDER TAIL IS 3.05 [0.120].
- ⑤ SPECIALLY FOR ONE-PORT P/N 94910-X01AM,-X01AMLF & 94910-X01ANLF ONLY. SOLDER TAIL OF SHIELD IS 1.27 [0.050] WIDE, DISTANCE FROM PCB PEG TO THE SOLDER TAIL IS 3.05 [0.120].
6. ALL DIMENSIONS IN MILLIMETERS/INCHES.
- ⑦ CENTER PEG FOR 8-PORTS AND ABOVE, (-XXXM,-XXXMLF PRODUCT ONLY).
- ⑧ NO CENTER PEG AVAILABLE ON -XXXNLF PRODUCT.
- ⑨ "LF" SUFFIX AT THE END OF PART NUMBER IS LEAD FREE.
10. THE HOUSING WILL WITHSTAND EXPOSURE TO 260°C PEAK TEMPERATURE FOR 15 SECONDS IN A WAVE SOLDER APPLICATION WITH A 1.5mm MINIMUM THICK CIRCUIT BOARD. SEE APPLICATION NOTES/PROCEDURES IF THEY ARE AVAILABLE.
11. THIS PRODUCT MEETS EUROPEAN UNION DIRECTIVES AND OTHER COUNTRY REGULATION AS DESCRIBED IN GS-22-008
- ⑫ PLATING OPTIONS: MAY BE EITHER GOLD OR GXT PLATED AT MANUFACTURER'S OPTION.

mat'l. code		tolerances unless otherwise specified		CUSTOMER COPY		FCI	
ltr	ecn no	dr	date	linear	projection	www.fciconnect.com	
U				.X±.3/.XX ±.01		title	
				.XX±.13/.XXX ±.005		R/A 8 POS GANG JACK ASSY SHIELDED, SNAP PEG	
				.XXX±.051/.XXX ±.0020		product family MOD JACK	
				° ±2'		code	
				dr KCHOU 3/18/93	scale	size	
				enrg TC 3/18/93		dwg no	
				chr JTSAO 3/18/93		94910	
				appd JTSAO 3/18/93		sheet 2 of	
sheet	revision					cage code	
index	sheet						

ACAD

PDM: Rev:U

STATUS: Released 2006 Printed: Aug 01, 2010

Tous droits strictement réservés. Reproduction ou communication à des tiers interdite sous quelque forme que ce soit sans autorisation écrite du propriétaire. Property of FCI. No part to be reproduced FCI.



All rights strictly reserved. Reproduction or issue to third parties in any form without the prior written authority from the proprietor. Property of FCI. Copyright FCI.

PRODUCT No.	No. OF PORTS	DIM A +.60 [0.024] -0	DIM B	DIM C±.10 [0.004]	DIM D±.15 [0.006]	GROUND LEG NO. ON THE BACK (VIEW B)	NOTE
94910-X01M	1	15.74 [0.620]	-----	5.72 [0.225]	11.43 [0.450]	NONE	NOTE 4
94910-X01AM	1	15.74 [0.620]	-----	5.72 [0.225]	11.43 [0.450]	NONE	NOTE 5
94910-X04M	4	58.92 [2.320]	41.91 [1.650]	26.67 [1.050]	53.34 [2.100]	3	
94910-X08M	8	114.80 [4.520]	97.79 [3.850]	54.61 [2.150]	109.22 [4.300]	3	
94910-X01MLF	1	15.74 [0.620]	-----	5.72 [0.225]	11.43 [0.450]	NONE	NOTE 4
94910-X01AMLF	1	15.74 [0.620]	-----	5.72 [0.225]	11.43 [0.450]	NONE	NOTE 5
94910-X04MLF	4	58.92 [2.320]	41.91 [1.650]	26.67 [1.050]	53.34 [2.100]	3	
94910-X08MLF	8	114.80 [4.520]	97.79 [3.850]	54.61 [2.150]	109.22 [4.300]	3	
94910-X11MLF	1	15.74 [0.620]	-----	5.72 [0.225]	11.43 [0.450]	NONE	NOTE 4
94910-X11AMLF	1	15.74 [0.620]	-----	5.72 [0.225]	11.43 [0.450]	NONE	NOTE 5
94910-X14MLF	4	58.92 [2.320]	41.91 [1.650]	26.67 [1.050]	53.34 [2.100]	3	
94910-X18MLF	8	114.80 [4.520]	97.79 [3.850]	54.61 [2.150]	109.22 [4.300]	3	

0: MEETS WAVE SOLDER PROCESS PRODUCT NO.  
1: MEETS PIP PROCESS PRODUCT NO.

PLATING CODE X	PLATING (12)
0	.76uM/30u" G.X.T.
1	.38uM/15u" GOLD
3	.76uM/30u" GOLD
5	1.27uM/50u" GOLD

mat'l. code		tolerances unless otherwise specified		CUSTOMER COPY		FCI www.fciconnect.com		
ltr	ecr no	dr	date	linear	.X±.3/XX ±.01	projection	title	
U				angles	.XX±.13/XXX ±.005		R/A 8 POS GANG JACK ASSY SHIELDED, SNAP PEG	
					.XXX±.051/XXXX ±.0020		product family	MOD JACK
				dr	0° ±2°	MM/INCH	code	
				enrg	KCHOU 5/4/94		size	
				chr	TC 5/4/94		dwg no	94910
				appd	JTSAO 5/4/94		sheet	3 of
sheet index	revision sheet					scale	1:1	

Tous droits strictement réservés. Reproduction ou communication à des tiers interdite sous quelque forme que ce soit sans autorisation écrite du propriétaire. Property of FCI. No right of reproduction FCI.



All rights strictly reserved. Reproduction or issue to third parties in any form whatsoever is not permitted without written authority from the proprietor. Property of FCI. Copyright FCI.

PRODUCT No.	PORTS	DIM A $-0$	DIM B $\pm .20$ [0.008]	DIM C $\pm .10$ [0.004]	DIM D $\pm .15$ [0.006]	THE BACK (VIEW B)	
94910-X01NLF	1	15.74 [0.620]	-----	5.72 [0.225]	11.43 [0.450]	NONE	NOTE 4
94910-X01ANLF	1	15.74 [0.620]	-----	5.72 [0.225]	11.43 [0.450]	NONE	NOTE 5
94910-X04NLF	4	58.92 [2.320]	41.91 [1.650]	26.67 [1.050]	53.34 [2.100]	3	
94910-X08NLF	8	114.80 [4.520]	97.79 [3.850]	54.61 [2.150]	109.22 [4.300]	3	
94910-X11NLF	1	15.74 [0.620]	-----	5.72 [0.225]	11.43 [0.450]	NONE	NOTE 4
94910-X11ANLF	1	15.74 [0.620]	-----	5.72 [0.225]	11.43 [0.450]	NONE	NOTE 5
94910-X14NLF	4	58.92 [2.320]	41.91 [1.650]	26.67 [1.050]	53.34 [2.100]	3	
94910-X18NLF	8	114.80 [4.520]	97.79 [3.850]	54.61 [2.150]	109.22 [4.300]	3	

0: MEETS WAVE SOLDER PROCESS PRODUCT NO.  
1: MEETS PIP PROCESS PRODUCT NO.

PLATING CODE X	PLATING (2)
0	.76uM/30u" G.X.T.
1	.38uM/15u" GOLD
3	.76uM/30u" GOLD
5	1.27uM/50u" GOLD

mat'l. code		tolerances unless otherwise specified		CUSTOMER COPY		FCI www.fciconnect.com		
ltr	ecr no	dr	date	linear	projection	title		
U				.X $\pm$ .3/.XX $\pm$ .01		R/A 8 POS GANG JACK ASSY SHIELDED, SNAP PEG		
				.XXX $\pm$ .051/.XXXX $\pm$ .0020		product family	MOD JACK	code
				angles	0° $\pm$ 2°	size	dwg no	sheet
				dr	KCHOU 5/4/94	A 94910		4 of
				enrg	TC 5/4/94			
				chr	JTSAO 5/4/94			
				appd	JTSAO 5/4/94			
sheet index	revision sheet							

ACAD

PDM: Rev:0

STATUS: Released 26 Printed: Aug 01, 2014



### LATCHING AND GROUNDING TAB LOCATING CONFIGURATION

- INDICATES LATCHING TAB (SEE SHEET 1)
- INDICATES GROUNDING TAB ON THE FRONT OF PRODUCT (SEE SHEET 1)
- ▨ INDICATES GROUNDING LEG ON THE BACK OF PRODUCT (VIEW B)

#### PORT NUMBERS

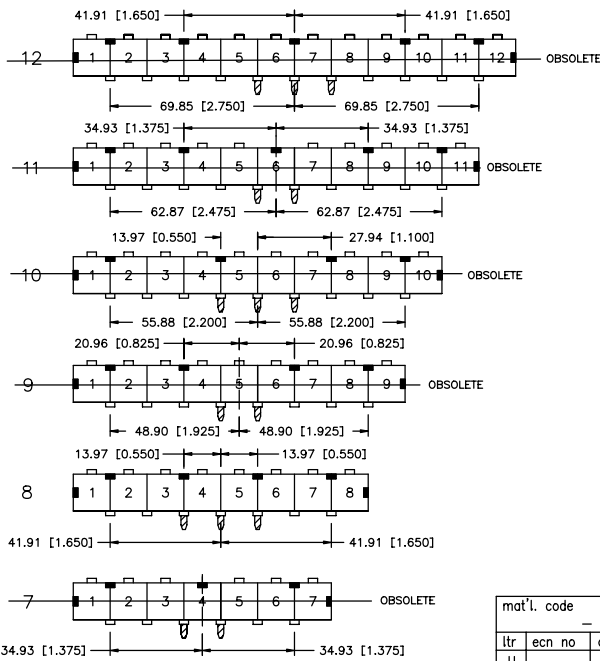

#### PORT NUMBERS

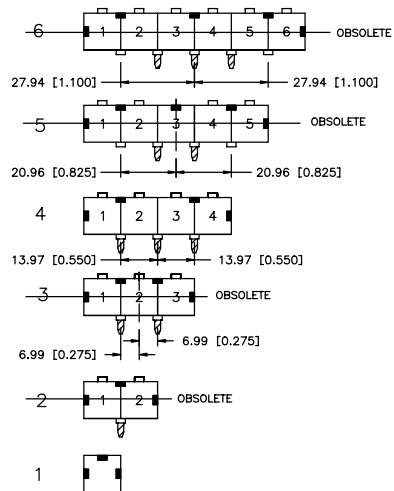

Tous droits strictement réservés. Reproduction ou communication à des tiers interdite sous quelque forme que ce soit sans autorisation écrite du propriétaire. Propriété de c FCI. Droits de reproduction FCI.

All rights strictly reserved. Reproduction or issue to third parties in any form whatever is not permitted without written authority from the proprietor. Property of FCI. Copyright FCI.

mat'l. code		tolerances unless otherwise specified		CUSTOMER COPY		FCI www.fciconnect.com	
ltr	ecn no	dr	date	linear	.X±.3/.XX ±.01	projection	title
u					.XX±.13/.XXX ±.005		R/A 8 POS GANG JACK ASSY SHIELDED, SNAP PEG
				angles	.XXX±.051/.XXXX ±.0020		product family
				dr	KCHOU 5/4/94	MM/INCH	code
				engr	TC 5/4/94	scale	94910
				chr	JTSAO 5/4/94	1:1	sheet
				appd	JTSAO 5/4/94		6 of
sheet index	revision sheet						

ACAD

PDM: Rev:U

STATUS: Released 22626 Printed: Aug 01, 2010