

REV	DATE	DESCRIPTION	BY	CHK	APP
00	E1	REVISED PER ECO-11-005027			

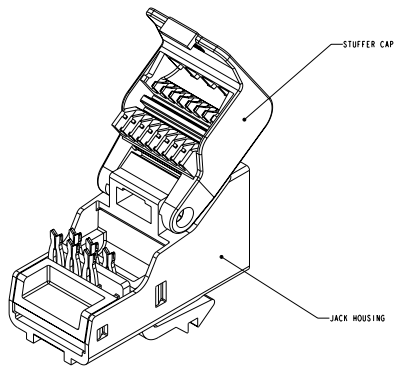

OPEN POSITION

- △ MATERIAL: JACK HOUSING - POLYPHENYLENE OXIDE, 94V-0 RATED; TERMINAL BLOCK - POLYPHENYLENE OXIDE, 94V-0 RATED; STUFFER CAP - POLYCARBONATE, CLEAR, 94V-0 RATED; JACK CONTACTS - PHOSPHOROUS BRONZE, PLATED WITH 1.27µm (.00050) MINIMUM THICK GOLD IN LOCALIZED AREA AND 3.81µm (.00150) MINIMUM THICK MATTE TIN IN SOLDER AREA OVER 1.27µm (.00050) MINIMUM THICK NICKEL UNDERPLATE.
- 2. TOOLLESS WILL TERMINATE 22-24 AWG SOLID CONDUCTORS AND 24 AWG STRANDED CONDUCTORS, 1.14 (.045) MAXIMUM INSULATION DIAMETER.
- △ CAVITY CONFORMS TO FCC RULES AND REGULATIONS PART 68 SUBPART F REQUIREMENTS.
- 4. MOUNTING PANEL THICKNESS 1.473 - 1.600 (.058 - .063).
- △ THESE TWO SUGGESTED CUTOY OPENINGS ARE USED IN TANDEN WITH DUAL FRONT AND BACK CUTOYTS.
- △ ONE MODULAR JACK ASSEMBLY PER POLYBAG.
- △ ASSEMBLY SHIPPED WITH STUFFER CAP NOT LATCHED AT REAR OF HOUSING ASSEMBLY AS SHOWN.

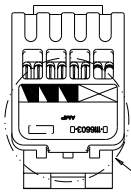

SEE DETAIL A

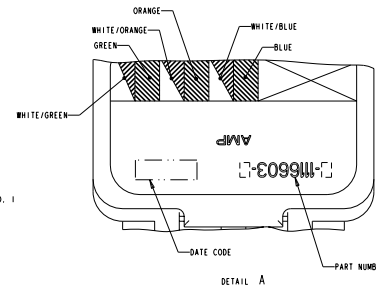
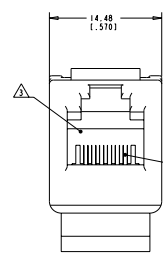
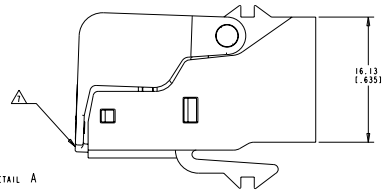

DETAIL A  
SCALE 10:1

COLOR CODE	IDC TERMINAL	MODULAR JACK
WHITE/BLUE	4	4
BLUE	3	3
WHITE/ORANGE	2	2
ORANGE	5	5
WHITE/GREEN	1	1
GREEN	6	6
WHITE/BROWN		
BROWN		

ELECTRICAL SCHEMATIC (USDC)

COLOR CODE	IDC TERMINAL	MODULAR JACK
GREEN	4	4
RED	3	3
BLACK	2	2
YELLOW	5	5
WHITE	1	1
BLUE	6	6

ELECTRICAL SCHEMATIC (USDC)

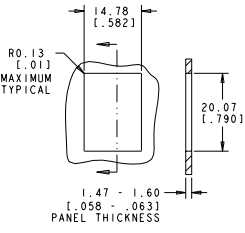

SINGLE PANEL CUTOY

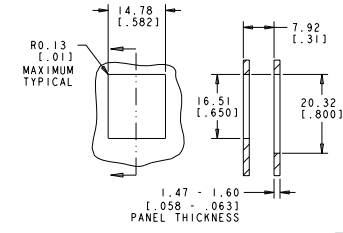

SUGGESTED FLUSH MOUNT  
PANEL APPLICATION CUTOY

PACKAGE	HOUSING COLOR	PART NUMBER
△	ELECTRIC IVORY	1116603-1
	VIOLET	1116603-0
	GREEN	1116603-9
	YELLOW	1116603-8
	RED	1116603-7
	BLUE	1116603-6
	ORANGE	1116603-5
	NEAL GRAY	1116603-4
	WHITE	1116603-3
	BLACK	1116603-2
	LIGHT ALMOND	1116603-1

THIS DRAWING IS A CONTROLLED DOCUMENT.

DATE: 05/09/98  
 DRAWN BY: J.P.P.  
 CHECKED BY: J.P.P.  
 APPROVED BY: J.P.P.  
 PART NUMBER: 1116603-3  
 TITLE: ASSEMBLY, TOOLLESS JACK, CAT 3, 6 POSITION  
 STATE: CA  
 CITY: SAN JOSE  
 CUSTOMER DRAWING: 1116603-3