

VPP 12 - 800

Electrical Specifications (@25C)

1. Maximum Power: 10.0VA
2. Secondary: Series: 12.6V CT@ 0.8A
Parallel: 6.3V @ 1.6A
3. Voltage Regulation: 25% TYP @ full load to no load
4. Temperature Rise: 30C TYP (45C MAX allowed)
5. Insulation Resistance: 100MΩ

Construction:

Dual bobbin construction with an insulated shroud, both made of a high temperature material that exceeds UL flammability requirements.

Safety:

These units are designed with 4000VAC isolation between the primary and secondary, and also, between each winding and the core. Since the dual bobbin construction effectively reduces capacitance, electrostatic shielding is not required. World Series Transformers are designed and manufactured to meet the following agency approvals:



Agency File:

UL: File E53148, UL 506, General Purpose.
CSA: File LR 37220. C22.2 NO. 66, General Purpose.
VDE: File 18786-3390-0001, VDE/EN 60 950, (IEC950) information Technology Equipment.

A. Dimensions: Units: In inches

A	B	C	D	E	F	G	H
1.25	1.375	.187	.200	.400	1.562	1.875	1.140

B. PIN DIM. : 0.036 SQ

C. WT Lbs. : 0.53

D. Mounting Holes: .112 dia. x 2.

E. Schematic Diagram:

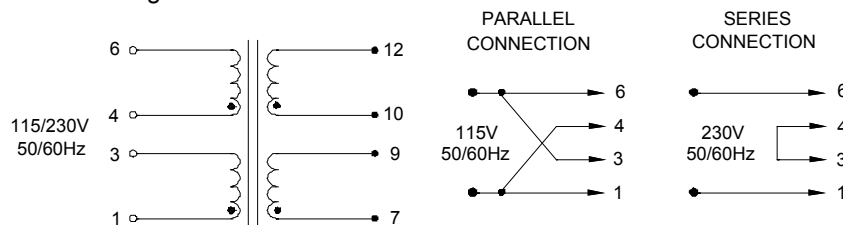

RoHS Compliance: As of manufacturing date February 2005, all standard products meet the requirements of 2002/95/EC, known as the RoHS initiative.

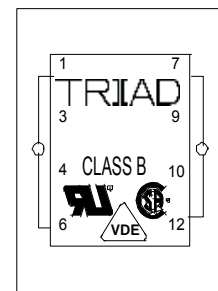
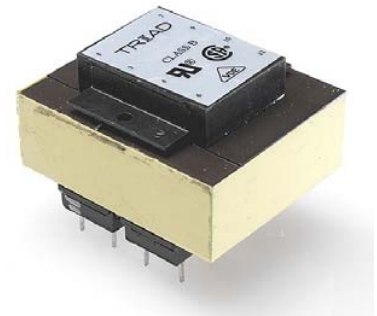

A

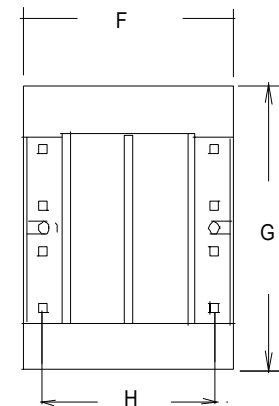
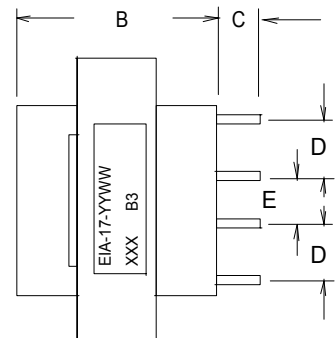

Power Transformers

VDE File: 18786-3390-0001

Class B

UL File: E53148

CSA File: 221330



PC Mount: World Series™

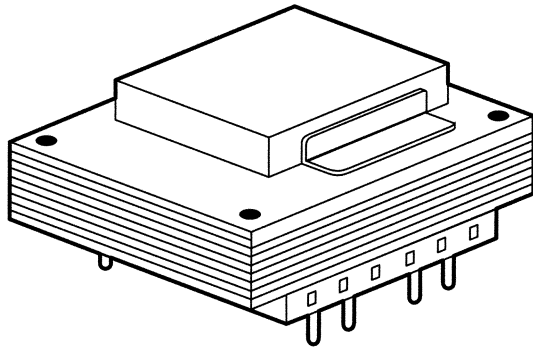

:: Description

Triad PC mount World Series transformers incorporate a dual bobbin construction with an insulating shroud, both made of a high temperature material that exceeds UL flammability requirements. These units are designed with very high isolation between the primary and secondary, and also, between each winding and the core. Since the dual bobbin construction effectively reduces capacitance, electrostatic shielding is not required. PC mount transformers are available with ratings from 2.5 VA 56.0 VA and have dimensionally accurate pin placement for through hole PC board mounting. All World Series transformers meet U.S. and International standards including CSA, IEC, VDE and UL requirements, and therefore have universal application.

:: Specifications

Primary: 115/230 V, 50/60 Hz | VA Ranges: 2.5 to 56.0

:: World Series

Section	Type No.	VA	Secondary		Dimensions						Pin Dim.	Mounting			WT Lbs.
			Series	Parallel	H	W	D	A	B	C		ML	MD	MW	
A	VPP10-250*	2.5	10.0V CT @ 0.25A	5.0V @ 0.5A	1 ¹ / ₈	1 ¹ / ₈	1 ¹ / ₁₆	.200	.250	1.000	0.025 Sq.	1 ¹ / ₁₆	•	•	0.25
	VPP10-500	5.0	10.0V CT @ 0.5A	5.0V @ 1.0A	1 ¹ / ₈	1 ¹ / ₈	1 ¹ / ₁₆	.200	.400	1.000	0.025 Sq.	1 ¹ / ₁₆	•	•	0.37
	VPP10-1000	10.0	10.0V CT @ 1.0A	5.0V @ 2.0A	1 ¹ / ₈	1 ¹ / ₈	1 ¹ / ₁₆	.200	.400	1.140	0.036 Sq.	1 ¹ / ₄	•	•	0.53
	VPP10-2000	20.0	10.0V CT @ 2.0A	5.0V @ 4.0A	1 ¹ / ₈	2 ¹ / ₄	1 ¹ / ₈	.400	.400	1.460	0.036 Sq.	1 ¹ / ₂	•	•	0.90
	VPP10-3000	30.0	10.0V CT @ 3.0A	5.0V @ 6.0A	1 ¹ / ₁₆	2 ³ / ₈	2 ³ / ₁₆	.550	.275	1.680	0.045 Sq.	•	1 ³ / ₄	2 ³ / ₁₆	1.15
	VPP10-5600	56.0	10.0V CT @ 5.6A	5.0V @ 11.2A	1 ⁹ / ₁₆	3	2 ¹ / ₂	.600	.300	1.900	0.045 Sq.	•	2	2 ¹ / ₂	1.70
B	VPP12-200*	2.5	12.6V CT @ 0.2A	6.3V @ 0.4A	1 ¹ / ₈	1 ¹ / ₈	1 ¹ / ₁₆	.200	.250	1.000	0.025 Sq.	1 ¹ / ₁₆	•	•	0.25
	VPP12-400	5.0	12.6V CT @ 0.4A	6.3V @ 0.8A	1 ¹ / ₈	1 ¹ / ₈	1 ¹ / ₁₆	.200	.400	1.000	0.025 Sq.	1 ¹ / ₁₆	•	•	0.37
	VPP12-800	10.0	12.6V CT @ 0.8A	6.3V @ 1.6A	1 ¹ / ₈	1 ¹ / ₈	1 ¹ / ₁₆	.200	.400	1.140	0.036 Sq.	1 ¹ / ₄	•	•	0.53
	VPP12-1600	20.0	12.6V CT @ 1.6A	6.3V @ 3.2A	1 ¹ / ₈	2 ¹ / ₄	1 ¹ / ₈	.400	.400	1.460	0.036 Sq.	1 ¹ / ₂	•	•	0.90
	VPP12-2400	30.0	12.6V CT @ 2.4A	6.3V @ 4.8A	1 ¹ / ₁₆	2 ³ / ₈	2 ³ / ₁₆	.550	.275	1.680	0.045 Sq.	•	1 ³ / ₄	2 ³ / ₁₆	1.15
	VPP12-4400	56.0	12.6V CT @ 4.4A	6.3V @ 8.8A	1 ⁹ / ₁₆	3	2 ¹ / ₂	.600	.300	1.900	0.045 Sq.	•	2	2 ¹ / ₂	1.70
C	VPP16-150*	2.5	16.0V CT @ 0.15A	8.0V @ 0.3A	1 ¹ / ₈	1 ¹ / ₈	1 ¹ / ₁₆	.200	.250	1.000	0.025 Sq.	1 ¹ / ₁₆	•	•	0.25
	VPP16-310	5.0	16.0V CT @ 0.31A	8.0V @ 0.62A	1 ¹ / ₈	1 ¹ / ₈	1 ¹ / ₁₆	.200	.400	1.000	0.025 Sq.	1 ¹ / ₁₆	•	•	0.37
	VPP16-620	10.0	16.0V CT @ 0.62A	8.0V @ 1.25A	1 ¹ / ₈	1 ¹ / ₈	1 ¹ / ₁₆	.200	.400	1.140	0.036 Sq.	1 ¹ / ₄	•	•	0.53
	VPP16-1250	20.0	16.0V CT @ 1.25A	8.0V @ 2.5A	1 ¹ / ₈	2 ¹ / ₄	1 ¹ / ₈	.400	.400	1.460	0.036 Sq.	1 ¹ / ₂	•	•	0.90
	VPP16-1900	30.0	16.0V CT @ 1.9A	8.0V @ 3.8A	1 ¹ / ₁₆	2 ³ / ₈	2 ³ / ₁₆	.550	.275	1.680	0.045 Sq.	•	1 ³ / ₄	2 ³ / ₁₆	1.15
	VPP16-3500	56.0	16.0V CT @ 3.5A	8.0V @ 7.0A	1 ⁹ / ₁₆	3	2 ¹ / ₂	.600	.300	1.900	0.045 Sq.	•	2	2 ¹ / ₂	1.70
D	VPP20-120*	2.5	20.0V CT @0.12A	10.0V @ 0.24A	1 ¹ / ₈	1 ¹ / ₈	1 ¹ / ₁₆	.200	.250	1.000	0.025 Sq.	1 ¹ / ₁₆	•	•	0.25
	VPP20-250	5.0	20.0V CT @0.25A	10.0V @ 0.5A	1 ¹ / ₈	1 ¹ / ₈	1 ¹ / ₁₆	.200	.400	1.000	0.025 Sq.	1 ¹ / ₁₆	•	•	0.37
	VPP20-500	10.0	20.0V CT @0.5A	10.0V @ 1.0A	1 ¹ / ₈	1 ¹ / ₈	1 ¹ / ₁₆	.200	.400	1.140	0.036 Sq.	1 ¹ / ₄	•	•	0.53
	VPP20-1000	20.0	20.0V CT @1.0A	10.0V @ 2.0A	1 ¹ / ₈	2 ¹ / ₄	1 ¹ / ₈	.400	.400	1.460	0.036 Sq.	1 ¹ / ₂	•	•	0.90
	VPP20-1500	30.0	20.0V CT @1.5A	10.0V @ 3.0A	1 ¹ / ₁₆	2 ³ / ₈	2 ³ / ₁₆	.550	.275	1.680	0.045 Sq.	•	1 ³ / ₄	2 ³ / ₁₆	1.15
	VPP20-2800	56.0	20.0V CT @2.8A	10.0V @ 5.6A	1 ⁹ / ₁₆	3	2 ¹ / ₂	.600	.300	1.900	0.045 Sq.	•	2	2 ¹ / ₂	1.70
E	VPP24-100*	2.5	24.0V CT @0.1A	12.0V @ 0.2A	1 ¹ / ₈	1 ¹ / ₈	1 ¹ / ₁₆	.200	.250	1.000	0.025 Sq.	1 ¹ / ₁₆	•	•	0.25
	VPP24-210	5.0	24.0V CT @0.21A	12.0V @ 0.42A	1 ¹ / ₈	1 ¹ / ₈	1 ¹ / ₁₆	.200	.400	1.000	0.025 Sq.	1 ¹ / ₁₆	•	•	0.37
	VPP24-420	10.0	24.0V CT @0.42A	12.0V @ 0.84A	1 ¹ / ₈	1 ¹ / ₈	1 ¹ / ₁₆	.200	.400	1.140	0.036 Sq.	1 ¹ / ₄	•	•	0.53
	VPP24-830	20.0	24.0V CT @0.83A	12.0V @ 1.66A	1 ¹ / ₈	2 ¹ / ₄	1 ¹ / ₈	.400	.400	1.460	0.036 Sq.	1 ¹ / ₂	•	•	0.90
	VPP24-1250	30.0	24.0V CT @1.25A	12.0V @ 2.50A	1 ¹ / ₁₆	2 ³ / ₈	2 ³ / ₁₆	.550	.275	1.680	0.045 Sq.	•	1 ³ / ₄	2 ³ / ₁₆	1.15
	VPP24-2330	56.0	24.0V CT @2.33A	12.0V @ 4.66A	1 ⁹ / ₁₆	3	2 ¹ / ₂	.600	.300	1.900	0.045 Sq.	•	2	2 ¹ / ₂	1.70
F	VPP28-090*	2.5	28.0V CT @0.09A	14.0V @ 0.18A	1 ¹ / ₈	1 ¹ / ₈	1 ¹ / ₁₆	.200	.250	1.000	0.025 Sq.	1 ¹ / ₁₆	•	•	0.25
	VPP28-180	5.0	28.0V CT @0.18A	14.0V @ 0.36A	1 ¹ / ₈	1 ¹ / ₈	1 ¹ / ₁₆	.200	.400	1.000	0.025 Sq.	1 ¹ / ₁₆	•	•	0.37
	VPP28-360	10.0	28.0V CT @0.36A	14.0V @ 0.72A	1 ¹ / ₈	1 ¹ / ₈	1 ¹ / ₁₆	.200	.400	1.140	0.036 Sq.	1 ¹ / ₄	•	•	0.53
	VPP28-720	20.0	28.0V CT @0.72A	14.0V @ 1.44A	1 ¹ / ₈	2 ¹ / ₄	1 ¹ / ₈	.400	.400	1.460	0.036 Sq.	1 ¹ / ₂	•	•	0.90
	VPP28-1060	30.0	28.0V CT @1.06A	14.0V @ 2.12A	1 ¹ / ₁₆	2 ³ / ₈	2 ³ / ₁₆	.550	.275	1.680	0.045 Sq.	•	1 ³ / ₄	2 ³ / ₁₆	1.15
	VPP28-2000	56.0	28.0V CT @2.0A	14.0V @ 4.0A	1 ⁹ / ₁₆	3	2 ¹ / ₂	.600	.300	1.900	0.045 Sq.	•	2	2 ¹ / ₂	1.70
G	VPP36-070*	2.5	36.0V CT @0.07A	18.0V @ 0.14A	1 ¹ / ₈	1 ¹ / ₈	1 ¹ / ₁₆	.200	.250	1.000	0.025 Sq.	1 ¹ / ₁₆	•	•	0.25
	VPP36-140	5.0	36.0V CT @0.14A	18.0V @ 0.28A	1 ¹ / ₈	1 ¹ / ₈	1 ¹ / ₁₆	.200	.400	1.000	0.025 Sq.	1 ¹ / ₁₆	•	•	0.37
	VPP36-280	10.0	36.0V CT @0.28A	18.0V @ 0.56A	1 ¹ / ₈	1 ¹ / ₈	1 ¹ / ₁₆	.200	.400	1.140	0.036 Sq.	1 ¹ / ₄	•	•	0.53
	VPP36-560	20.0	36.0V CT @0.56A	18.0V @ 1.12A	1 ¹ / ₈	2 ¹ / ₄	1 ¹ / ₈	.400	.400	1.460	0.036 Sq.	1 ¹ / ₂	•	•	0.90
	VPP36-820	30.0	36.0V CT @0.82A	18.0V @ 1.64A	1 ¹ / ₁₆	2 ³ / ₈	2 ³ / ₁₆	.550	.275	1.680	0.045 Sq.	•	1 ³ / ₄	2 ³ / ₁₆	1.15
	VPP36-1560	56.0	36.0V CT @1.56A	18.0V @ 3.12A	1 ⁹ / ₁₆	3	2 ¹ / ₂	.600	.300	1.900	0.045 Sq.	•	2	2 ¹ / ₂	1.70

CT = Center Tap * Note: All 2.5 VA units are Class 2 UL File: E63390.

:: Outline Dimensions

Technical Notes

1. Hi-pot tested at 4,000 VRMS.
2. Both primary and secondary coils may be connected as either series or parallel, but both must be used simultaneously.

