

# VPL10-500

### Electrical Specifications (@25C)

1. Maximum Power: 5.0VA
2. Input Voltage – **Series**: 230VAC @ 50/60Hz, **Parallel**: 115VAC @ 50/60Hz
3. Output Voltage – **Series**<sup>1</sup>: 10.0V CT @ 0.500A, **Parallel**<sup>2</sup>: 5.0V @ 1.00A
4. Voltage Regulation: 20% TYP @ full load to no load
5. Hipot: 3500VAC between primary to secondary and windings to core.

### Construction:

Dual winding construction with an insulated shroud, both made of a high temperature material that exceeds UL flammability requirements. Shrouds are provided over the connections of the leads to the windings on both primary and secondary coils. Devices are designed with a minimum of 6mm creepage distance between the primary and secondary and are manufactured with a Class B (130°C) insulation system.

### Agency Files:

UL File: E65390, UL 5085-1 and 3 (formerly UL1585), Class 2/3  
 cUL: File E65390, For Canadian Use (CSA 22.2, No.66.1-06 and No.66.3-06)  
 TUV Certificate No.: R72072385, EN60950, Information Technology



Dimensions: Units: In inches

A	B	C	D	E	F
1.437	2.375	1.437	2.00	8.00	0.187

Weight: 0.4 lbs.

### Connections<sup>3</sup>:

**Input:** Series – BLK to BLU, Jumper WHT to BRN  
 Parallel – BLK to BLU, Jumper BLK to BRN and WHT to BLU

**Output:** Series – RED to GRY, Jumper YEL to VIO  
 Parallel – RED to GRY, Jumper RED to VIO and YEL to GRY

**RoHS Compliance:** As of manufacturing date February 2005, all standard products meet the requirements of 2002/95/EC, known as the RoHS initiative.

\* Upon printing, this document is considered "uncontrolled". Please contact Triad Magnetics' website for the most current version.

<sup>1</sup> Inherently limited. No fusing required. Class 2.

<sup>2</sup> Inherently limited. No fusing required. Class 2.

<sup>3</sup> Primary and secondary windings are designed to be connected in series or parallel. Winding are not intended to be used independently.

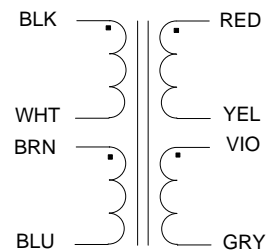
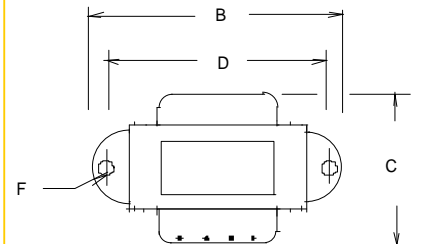
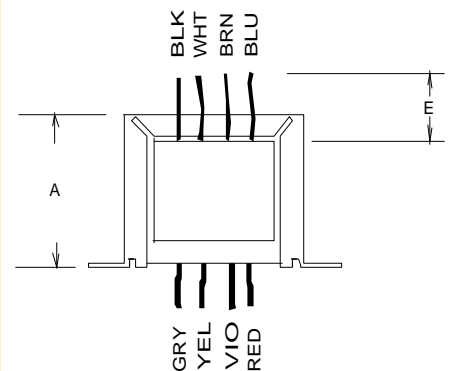

**SCHEMATIC**

Web: [www.TriadMagnetics.com](http://www.TriadMagnetics.com)  
 Phone 951-277-0757  
 Fax 951-277-2757

22520B Temescal Canyon Road  
 Corona, California  
 92883

Publish Date: October 26, 2009