

### FD7-36

#### Description:

The FD7-36 Quick Pack small power transformer offers a significant reduction in size and weight over a standard transformer. This transformer can be used for a wide variety of applications. It is bobbin wound for reduced size and small operating space.

#### Electrical Specifications (@25C):

**Maximum Power:** 56.0VA

#### Input Voltage:

**Series:** 230VAC@50/60Hz

**Parallel:** 115VAC@50/60Hz

**Output Voltage:** 36.0VCT@1.5A

#### Construction:

Split bobbing non concentric winding eliminates costly electrostatic shielding. Termination is suitable for quick connects or soldering.

#### Safety:

UL Class B E53148



#### Dimensions:

A	B	C	D	E	F	G
2.250	3.125	3.687	1.812	2.687	.187 Dia	1.062

- Notes:**
- Units: inches.
  - Terminal size: .187" X 0.021".
  - Weight: 1.70 lbs

#### Schematic:

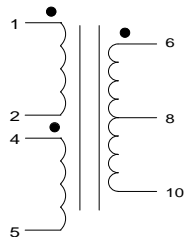

**Input (115V):** Input 1 to 2  
Connect 1 to 4, 2 to 5

**Input (230V):** Input 1 to 5  
Connect 2 to 4

**Output:** 6 to 10

**RoHS Compliance:** As of manufacturing date February 2005, all standard products meet the requirements of 2002/95/EC, known as the RoHS initiative.

\* Upon printing, this document is considered "uncontrolled". Please contact Triad Magnetics' website for the most current version.

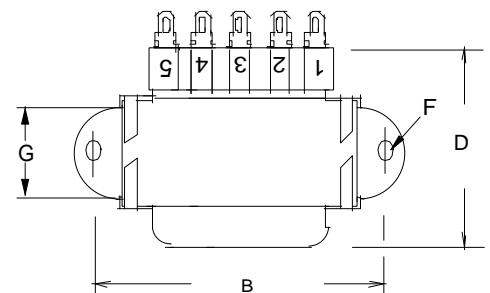
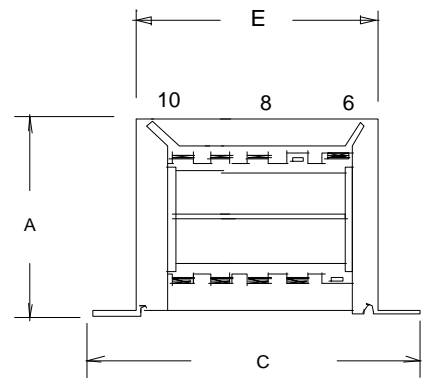

Web: [www.TriadMagnetics.com](http://www.TriadMagnetics.com)  
Phone 951-277-0757  
Fax 951-277-2757

22520B Temescal Canyon Road  
Corona, California  
92883

Publish Date: February 5, 2010