



**International
Components
Corporation**

TM

FW18 Series

18 Watts
Switch Mode Power Supply

Elpac Power Systems™
Higher Efficiency, Higher Power Density, Uncompromised Reliability



TECHNICAL SUPPORT

WORLDWIDE
1-888-357-2280
saleselpac@iccus.com
www.iccus.com

EUROPE
+44.1383.432920
saleseurope@iccus.com



- High Efficiency
- Fully Regulated DC Output
- Lifetime Expectation >5 years
- Hold-up Time >12ms at full load
- Safety Approval - EN60950-1 Class I
- ENERGY STAR Level V
- RoHS Compliant

5-YEAR LIMITED WARRANTY*

ENERGY STAR PARTNER

As a Global Supplier of Power Supplies, we are committed to meeting energy efficiency standards around the world. That is why we have partnered with the ENERGY STAR® Program and engineer our Elpac Power Systems™ to meet strict energy-efficiency guidelines established by the EPA and the US Department of Energy (DOE). The Energy Star program has developed International partnerships with countries and organizations in major global markets. Those participating in the program include Australia, Canada, European Union, European Free Trade Association, Japan, New Zealand, and Taiwan.

Furthering our International commitment, we have signed the EU Code of Conduct on Efficiency of External Power Supplies. Our Elpac Power Systems™ FW18 series meets the efficiency standards of the International ENERGY STAR® program and the EU Code of Conduct.

Input	
Input Voltage	85 – 264VAC 100 – 240VAC Nominal
Input Frequency	47 – 63Hz
Input Current	<0.5A rms
Inrush Current	<37A at 230VAC cold start
Zero Load Power Consumption	<0.5W
Touch Current/ Leakage Current	<200µA @ 132VAC @ 60Hz
	<350µA @ 264VAC @ 60Hz

Output	
Output Voltage	See Table
Total Regulation	+/-5%
Minimum Load	No minimum load required
Start-Up Delay	<1s
Hold-Up Time	>20ms at any input voltage
Ripple & Noise	<1% pk-pk **
Over Voltage Protection	110 – 135%
Over Temperature Protection	Active - Recoverable; plus Passive - Non Recoverable
Over Current Protection	120 – 180%
Short Circuit Protection	Shutdown, auto-restart (hiccup mode)

Notes

*visit www.iccus.com for complete details

**Ripple and noise measured with 20MHz bandwidth; 10µF tantalum capacitor in parallel with a 0.1µF ceramic capacitor.





Model Number	Output Voltage	Output Current	Peak Current ²	Total Regulation ³	Typical Efficiency ⁴
FW1805-760F	5.0V	3.0A	4.3A	±5%	82%
FW1812-760F	12.0V	1.5A	1.8A	±5%	83%
FW1815-760F	15.0V	1.2A	1.4A	±5%	84%
FW1818-760F	18.0V	1.0A	1.2A	±5%	85%
FW1824-760F	24.0V	0.8A	0.9A	±5%	86%

- Notes
 1) All models ship standard with US version input cable.
 2) Maximum peak load (21W) lasting 500ms with a maximum 10% duty cycle.
 3) Includes initial setting, line regulation, load regulation, and thermal drift.
 4) Typical at 115VAC (including output cable).

General	
Efficiency	Avg Efficiency 83.5% @ 115VAC; 81.6% @ 230VAC
MTBF	min. 100,000 hours demonstrated
Size	3.35" (85.0mm) x 1.97" (50.0mm) x 1.30" (33.0mm)
Weight	0.70 lbs (0.32 kg)

Environmental	
Operating Temperature	0 – 60°C (Full load to 40°C, derate linearly to 50% load at 60°C)
Storage Temperature	-40°C to +85°C
Relative Humidity	5-95%, non-condensing
Cooling	Natural Convection
Vibration	All units production tested to 19.6m/s ²

EMC & Safety	
Emissions	FCC class B, CISPR22 class B EN61000-3-2, -3
Immunity	EN61000-4-2, -3, -4, -5, -6, -8, -11
Certified by:	cTUVus
	UL 60950-1
	CAN/CSA-22.2 No.950
	CB per IEC60950-1
CE marked to LVD & EMC Directive	

Input Configuration	
Standard Input Cable	6 ft cable with US standard (Nema 5-15) 3 prong connector
Connection on Power Supply Body	IEC 320 C14 Receptacle

Output Configuration	
Standard Output Cable	6ft
Connector (PSU side)	Switchcraft 760 or equivalent
Mating Connector	Switchcraft 712A or equivalent

Output Pin Assignments		
Center	+V1	
Outside	Return	

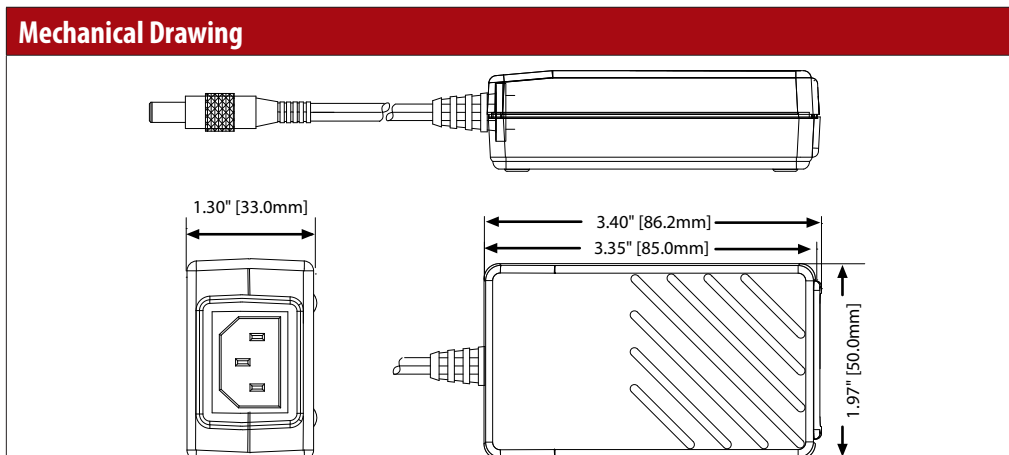

Ordering Options Available (Contact Factory)	
Without input cable	
Floating output	