

## AWSP60-24

### Description:

The AWSP60-24 is a single output power supply. This power supply is designed for a wide variety applications where high reliability is desired, including applications for the industrial and telecommunications markets. Excellent performance specifications are provided, together with compliance to European EMC (EN55022, Class B and EN61000-3-2), and Low Voltage directive (TUV EN60950).

### Specifications (@25C)

#### Input Characteristics:

Input Voltage:	85-264Vac
Input Frequency Range:	47-63Hz
Max Input Current:	1.3A @ Vin (rated)
Max Inrush Current:	20A@110Vac, 40A@220Vac at cold start
Leakage Current:	<3.5mA/240Vac

#### Output Characteristics:

Output Voltage:	24Vdc
Output Current:	2.5A
Output Power:	60W
Adjustable Output Range:	±10%
Ripple & Noise:	100mV
Load Regulation:	±0.5%
Line Regulation:	±0.5%
Efficiency:	81%
Temperature Drift:	<0.03%/°C (10-50°C)
Start-up Time:	300ms max @ 230Vac
Hold-up Time:	20ms min, 100% Load@230Vac
Rise-up Time:	300ms max, 100% Load@230Vac
Over Current Protection:	At Load>120% 115/230Vac, Shutdown
Over Voltage Protection:	Zener clamping at Vo>110%, Non auto recovery
Short Circuit Protection:	Short circuit protection available. Avoid short circuit >30 sec.

#### General Specifications:

Switching Frequency:	45kHz
Dimension (LxWxH):	160x98x38mm
Weight:	450g net, 490g gross
Cooling:	Natural Convection
Isolation Resistance:	I/P—O/P, I/P—FG, O/P—FG: 500VDC/100Mohms
Dielectric Strength:	I/P—O/P: 3KVac; I/P—FG: 2.5KVac; O/P—FG: 0.5KVac 1 min
Warranty:	2 years

#### Environmental Specifications:

Operating Temperature:	-10° to 60°C
Operating Humidity:	20 to 90% RH, non-condensing
Storage Temperature:	-25 to 75°C
Storage Humidity:	10 to 95% RH, non-condensing
Vibration:	10-55Hz, 2G 1min/cycle, period of 60min, each X, Y & Z axis

#### EMC & Safety Specifications:

EMC Emissions:	Conforms to EN55022,VCCI,CISPR22 Class B (Conducted & Radiated); IEC-61000-4-2, 61000-4-4, 61000-4-5, 61000-4-11
ESD Susceptibility:	EN61000-4-2 (15kV/8kV)
Radiated Susceptibility:	EN61000-4-3 (3V/m <sup>1</sup> )
Fast Burst:	EN61000-4-4 (2kV)
Surge:	EN61000-4-5 (1kV/2kV)
Safety Approval:	UL 60950 (UL File No: E204980) TUV EN60950 (TUV No: 50058679)

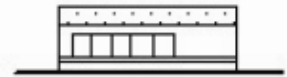

Mounting A

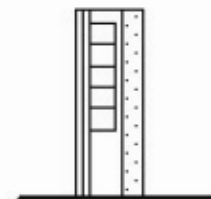

Mounting B

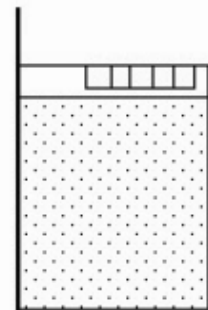

Mounting C

### Outline Dimensions (mm):

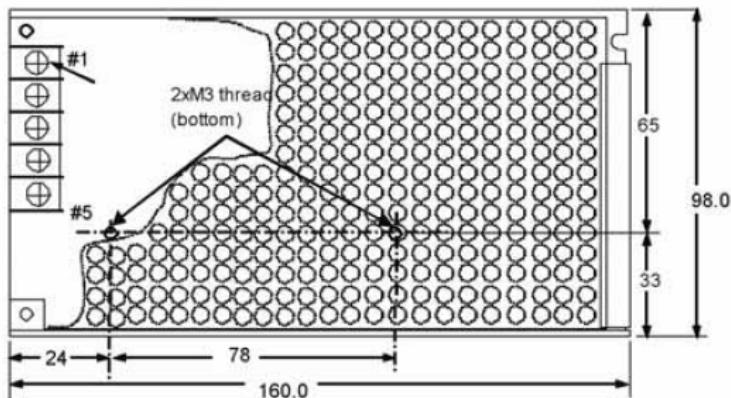

#### TERMINAL SCREW ASSIGNMENT

- # 1,2 : AC INPUT
- # 3 : FG (FRAME GROUND)
- # 4 : DC OUTPUT -V
- # 5 : DC OUTPUT +V

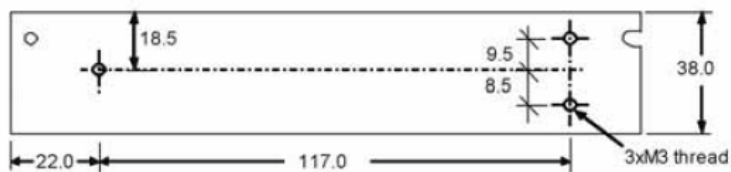

Unit : mm  
Tolerance : +/-1.0mm

### Derating Curve:

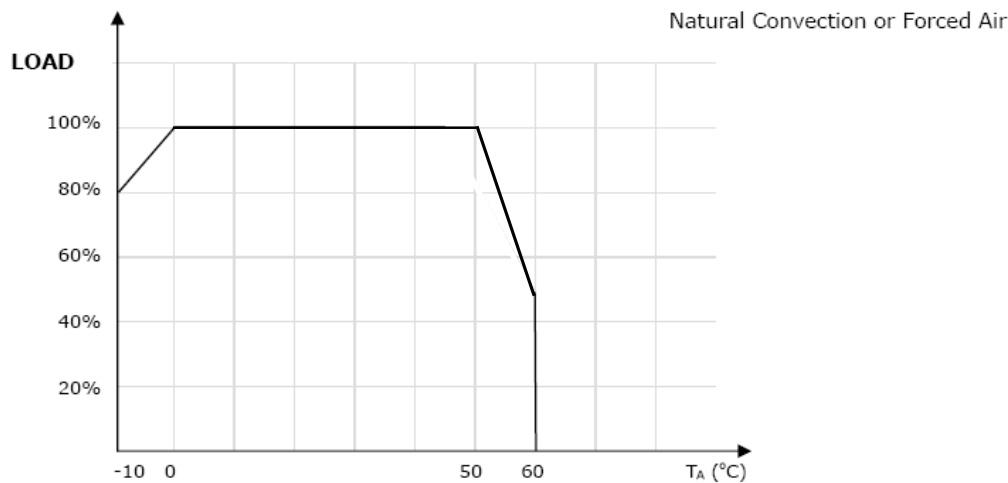

### Connector Types:

**Input:** Screw Terminals  
**Output:** Screw Terminals

**RoHS Compliance:** This power supply meets the requirements 2002/95/EC, know as the RoHS initiative.

# AWSP60 Series

60 Watt Single Output Enclosed Switching Power Supply for General Purpose Applications

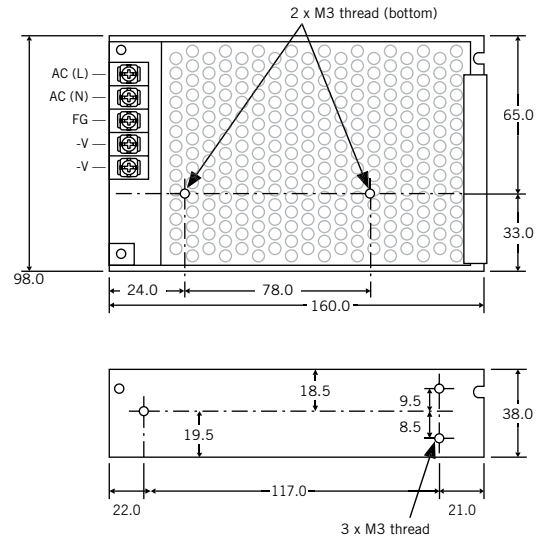

Unit: mm  
Tolerance: ±1.0mm



## SPECIFICATIONS (@25°C)

### Input Characteristics

Input Voltage: 85 - 264VAC  
 Input Frequency Range: 47 - 63Hz  
 Max Input Current: 1.3A (max)  
 Max Inrush Current: 20 / 40A @ 110 / 220 VAC (cold start)

### Output Characteristics

Minimum Load: No minimum load  
 Adjustable Output Range: ±10%  
 Ripple/Noise (pk-pk 20MHz): 5/12/24V = 75/100/100mV  
 Regulation: ±1.0% Load / ±0.5% Line  
 Hold-up Time: 30ms min, 100% Load @ 220 VAC  
 Rise-up Time: 300ms max @ 220 VAC  
 Over Current Protection: >120%, Auto-Recovery  
 Over Voltage Protection: >110% (Zener Diode)

### General Specifications

Switching Frequency: 45kHz  
 Dimension (LxWxH): 6.30 x 3.86 x 1.50" / 160 x 98 x 38mm  
 Weight: 450g  
 Warranty: 2 years

### Environmental Specifications

Operating Temperature: 0~+45°C Full Load, derate 3.33%/°C up to 60°C  
 Storage Temperature: -25~+75°C  
 Cooling: Convection Cooled Operation  
 Humidity: 10~95% RH, non-condensing  
 Vibration: 10 - 55Hz, 2G 1min / cycle, period of 60min, each axis  
 Reliability: >150,000 Hours MTBF

### EMC & Safety Specifications

EMC Emissions: EN55022,VCCI,CISPR22 Class B (Conducted & Radiated); IEC-61000-4-2, 61000-4-4, 61000-4-5, 61000-4-11  
 Safety Approval: UL 60950 (UL File No: E204980)  
 TUV EN60950 (TUV No: 50067240)  
 Dielectric Strength: Input-Output 3kVAC / 1min  
 Input-Ground 2.5kVAC / 1min  
 Insulation Resistance: Output-Ground: >100Mohm / 500VDC

## CONNECTOR TYPES

Input: Screw Terminals  
 Output: Screw Terminals

## MOUNTING OPTIONS

Forced air optional

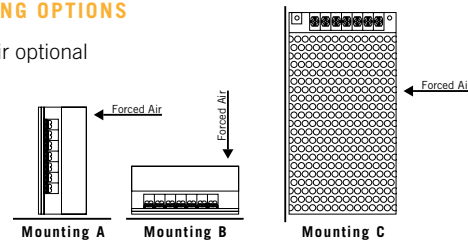

## DERATING CURVE

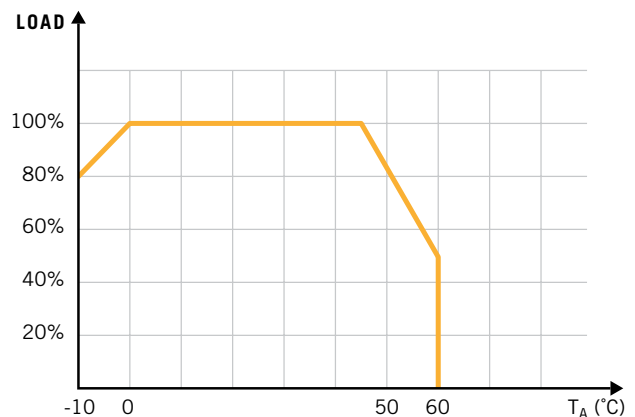

Part Number	Voltage	Current	Efficiency
AWSP60-5	5.0V	12A	73%
AWSP60-12	12V	5.0A	78%
AWSP60-24	24V	2.5A	81%