

Sealed Nickel Cadmium Batteries

Model: PS-SC

Specifications

Nominal Voltage		1.2 Volt
Rated Capacity		1500 mA
Dimensions	Diameter in. (mm)	0.87 (22.1)
	Height in. (mm)	1.65 (44.0)
	Height with solder tabs	1.69 (45.0)
	Weight Approx.	44 gm
	Internal Resistance	< 20 mΩ
	Standard Charge (0.1C)	150 mA
	Trickle Charge	(0.03C)~(0.05C)
	Fast Charge ΔV	1500 mA
Recommended Operating Temperature Range	Std/Trickle Charge	20±5°C
	Fast Charge	20±5°C
	Discharge	20±5°C
	Storage	-20°C to 45°C
Standard Discharge (0.2C) Cut Off Voltage		1.0V per cell
High Rate Discharge (1 C) Cut Off Voltage		1.0V per cell

Dimensions

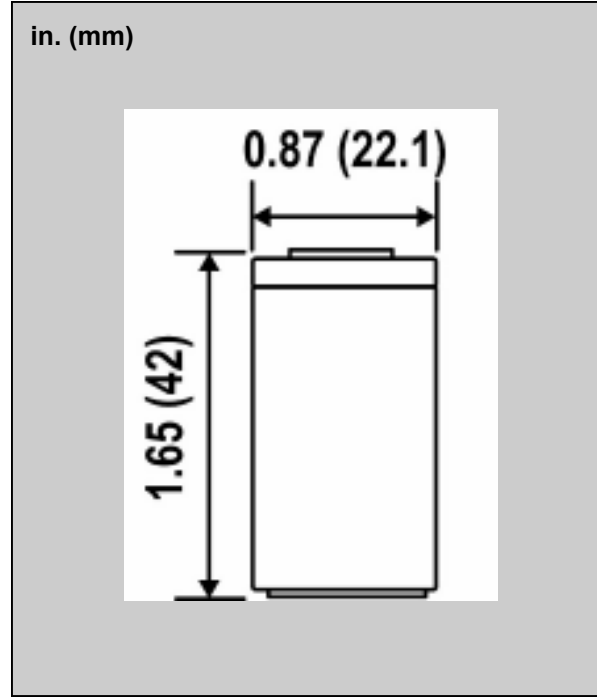

Charging and Discharging Characteristics

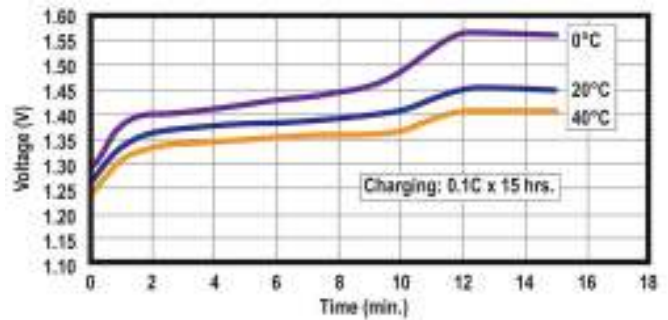
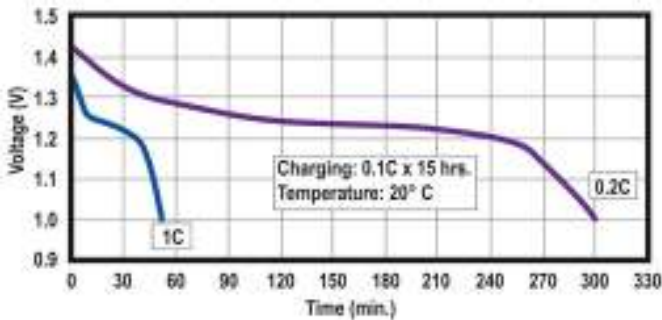

Discharge

Standard Charge

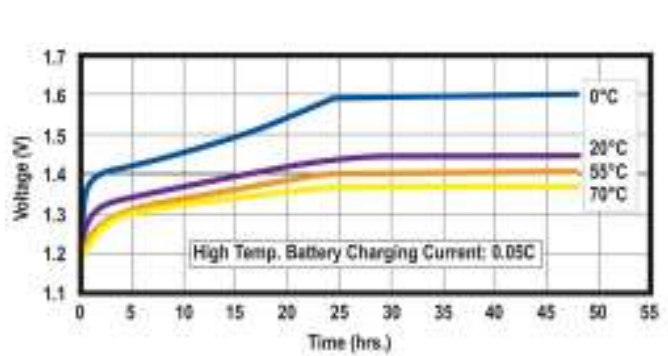
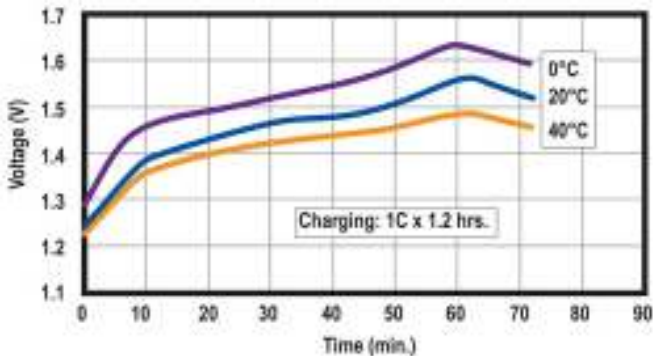

Fast Charge

Trickle Charge

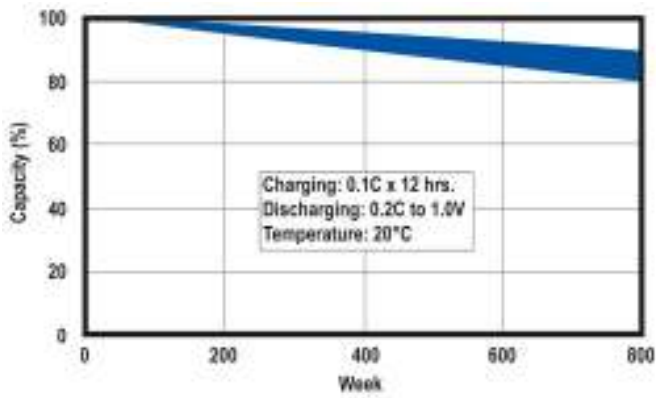

Standard Battery Cycle Life

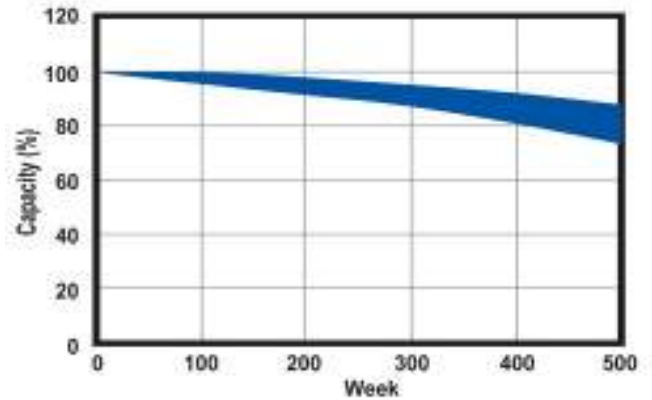

Fast Charging Cycle Life

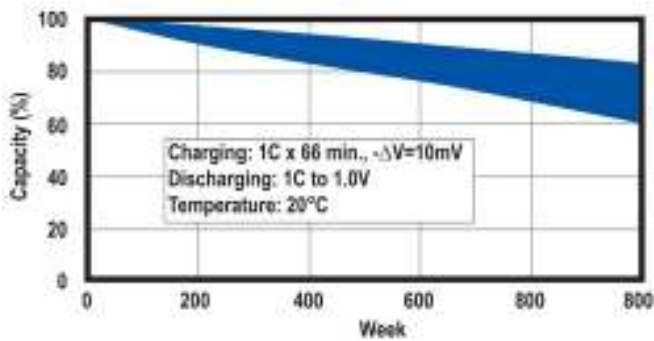

Cycle Life Using Trickle Charging

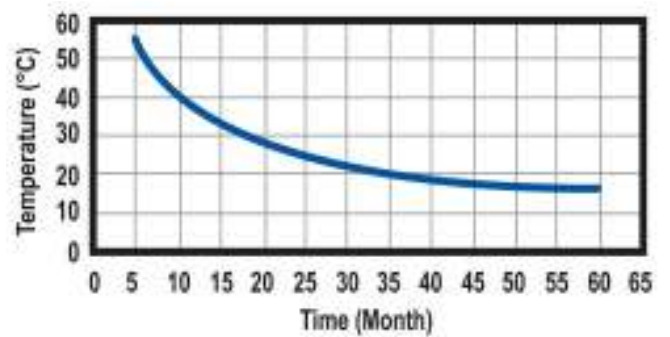

Stand-by Battery Life

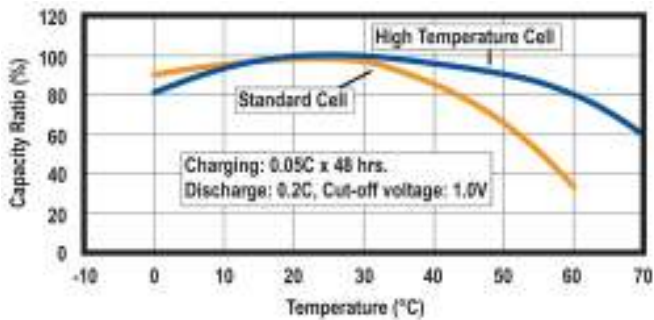

Capacity vs. Temperature

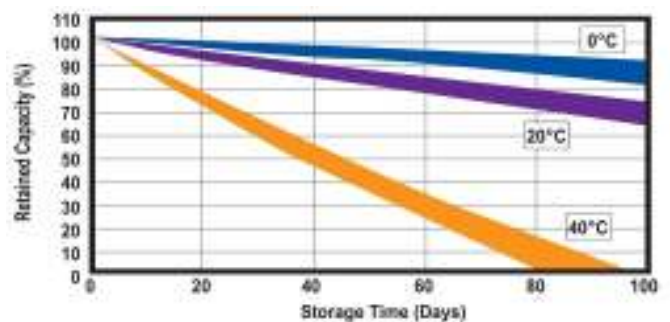

Retained Capacity In Storage

Corporate Headquarters and Domestic Sales

Power-Sonic Corporation • 7550 Panasonic Way • San Diego, CA 92154 • U.S.A

Phone: (619) 661-2020 • Fax: (619) 661.3650

Email Sales: national-sales@power-sonic.com

Email Customer Service: customer-service@power-sonic.com

E-mail Technical Support: technical-support@power-sonic.com

International Sales

Power-Sonic Corporation • P.O. Box 5242 • Redwood City, CA 94063 • U.S.A.

Phone: (650) 364-5001 • Fax: (650) 366-3662

Email Sales: international-sales.com@power-sonic.com

www.power-sonic.com

© Copyright 2010 Power-Sonic Corporation. All rights reserved