

Alle Rechte vorbehalten/ All rights reserved

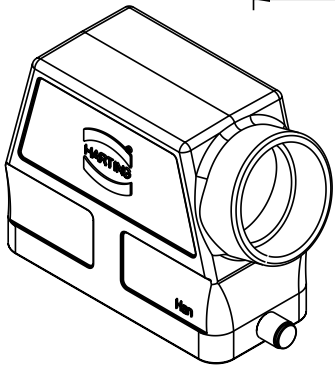
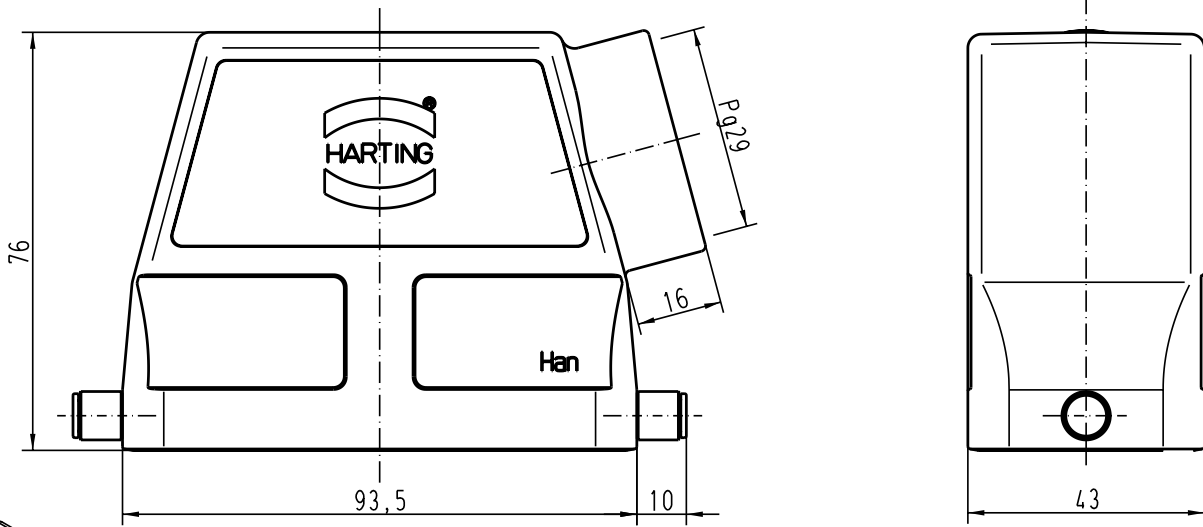

All Dimensions in mm Original Size DIN A 4		Techn. Character.			Nicht tolerierte Masse/ free size tolerances		
			Dat.	Name	Massestab/Scale	Han 16B-gs-R-29 Tüllengehäuse/ hoods side-entry	
			Detail.	10.10.01			1:1
			Insp.	KR			
			Stand.				
30161			HARTING Electric GmbH & Co. KG			TB 09 30 016 0541 Sub. TB 09 30 0.. 054. v.29.01.93	
Mod.	Dat.	Name	D-32339 Espelkamp				Blatt/ page