

# Tactile Switch B3F

## Miniature, Space-Saving Tactile Switch Provides Long Service Life and Easy Mounting





- Extended mechanical/electrical service life: 10 x 10<sup>6</sup> operations for 12 x 12 mm type and 1 x 10<sup>6</sup> operations for the 6 x 6 mm type
- Ideal for applications such as audio, office and communications equipment, measuring instruments, TVs, VCRs, etc.
- Taped radial type, vertical type and high force types are available as series versions
- Flux-tight base structure allows automatic soldering of the tactile switches onto a PC board
- Gold plated models available for increased contact reliability, resistance to corrosive gas and insulation fault prevention for ion migration in harsh environments
- RoHS Compliant



## Ordering Information

■ B3F-1□□□, B3F-3□□□

### 6 x 6 mm type

Type	Plunger	Switch height x pitch	Operating force	Model	
				Without ground terminal	With ground terminal
				Bags	Bags
Standard	Flat 	4.3 x 6.5 mm	General-purpose: 100 g	B3F-1000	B3F-1100
			150 g	B3F-1002	B3F-1102
			High-force: 260 g	B3F-1005	B3F-1105
		5.0 x 6.5 mm	General-purpose: 100 g	B3F-1020	B3F-1120
			150 g	B3F-1022	B3F-1122
			High-force: 260 g	B3F-1025	B3F-1125
	Projected 	7.3 x 6.5 mm	General-purpose: 100 g	—	B3F-1110
			150 g	B3F-1050	B3F-1150
			High-force: 260 g	B3F-1052	B3F-1152
Vertical	Flat 	3.15 mm	General-purpose: 100 g	—	B3F-3100
			150 g	—	B3F-3102
			High-force: 260 g	—	B3F-3105
		3.85 mm	General-purpose: 100 g	—	B3F-3120
			150 g	—	B3F-3122
			High-force: 260 g	—	B3F-3125
	Projected 	6.15 mm	General-purpose: 100 g	—	B3F-3150
			150 g	—	B3F-3152
			High-force: 260 g	—	B3F-3155

**Important Note: Switches cannot be water-washed.**

■ B3F-1□□□-G







6 x 6 mm type with Gold Plating

Type	Plunger	Switch height x pitch	Form of shipment operating force	Model	
				Without ground terminal	With ground terminal
Bags (100 Switches)					
6 x 6 mm switches with gold plating		4.3 x 6.5 mm	176 g	B3F-1002-G	B3F-1102-G
		5.0 x 6.5 mm		B3F-1022-G	B3F-1122-G

Note: The minimum order is 100 Switches. Order in multiples of the minimum order.

■ B3F-4□□□, B3F-5□□□



12 x 12 mm type

Type	Plunger	Switch height x pitch	Operating force	Model	
				Without ground terminal	With ground terminal
Bags					
Standard		4.3 x 12.5 mm	General-purpose: 130 g	B3F-4000	B3F-4100
			High-force: 260 g	B3F-4005	B3F-4105
		7.3 x 12.5 mm	General-purpose: 130 g	B3F-4050	B3F-4150
			High-force: 260 g	B3F-4055	B3F-4155
Long service life		4.3 x 12.5 mm	General-purpose: 130 g	B3F-5000	B3F-5100
		7.3 x 12.5 mm		B3F-5050	B3F-5150
High reliability gold-plated contact		4.3 x 12.5 mm		B3F-5001	B3F-5101
		7.3 x 12.5 mm		B3F-5051	B3F-5151

Important Note: Switches cannot be water-washed.

■ B3F-6□□□

**Taped Radial (Auto Insertion)  
6 x 6 mm type**

Type	Plunger	Switch height x pitch	Operating force	Model	
				Without ground terminal	With ground terminal
B3F-6000	Flat 	4.3 x 6.5 mm	General-purpose: 100 g	<b>B3F-6000</b>	<b>B3F-6100</b>
			High-force: 150 g	<b>B3F-6002</b>	<b>B3F-6102</b>
		5.0 x 6.5 mm	General-purpose: 100 g	<b>B3F-6020</b>	<b>B3F-6120</b>
			High-force: 150 g	<b>B3F-6022</b>	<b>B3F-6122</b>
	Projected 	7.3 x 6.5 mm	General-purpose: 100 g	<b>B3F-6050</b>	<b>B3F-6150</b>
			High-force: 150 g	<b>B3F-6052</b>	<b>B3F-6152</b>

**Note:** The above switches must be ordered in units of 1,000.

**Important Note:** Switches cannot be water-washed.

■ **Accessories**

See "B32" Tactile Switch Key Top data sheet for keycaps that fit projected plunger B3F models.

■ **Plunger Identification Table**

Use this table to determine tactile switch type by plunger color.

Plunger color	Operating force	Type
Light gray	100 g	B3F-1000, 1150, 3100, 6000, 6050
White	100 g	B3F-1050, 1100, 3150, 4000, 4050, 4100
Black	100 g	B3F-1020, 1110, 1120, 3120, 6020, 6120
Blue	130 g	B3F-5000 Series
Yellow	150 g	B3F-1002, 1052, 1102, 3102, 3152, 4005, 4055, 4105, 4155, 6002, 6052
Medium gray	150 g	B3F-1022, 1122, 3122, 6022
Orange	260 g	B3F-1005, 1055, 1105, 3105, 6005, 6055
Pink	260 g	B3F-1025, 1125, 3125, 6025

# Specifications

## ■ Characteristics

	Part Number				
	B3F-1□□□ B3F-3□□□	B3F-4□□□	B3F-5□□□	B3F-6□□□	B3F-1□□□-G
<b>Weight (see note 2)</b>	Approx. 0.25 g	Approx. 0.85 g		Approx. 0.25 g	
<b>Contact form</b>	SPST-NO				SPST-NO
<b>Switching capacity</b>	1 to 50 mA, 5 to 24 VDC (resistive load)				100 μA to 50 mA, 5 to 24 VDC (resistive load)
<b>Contact resistance</b>	100 MΩ max. (Initial Value, Rated: 1mA, 5VDC)				100 MΩ max. (initial value) (rated: 100 μA, 5 VDC)
<b>Insulation resistance</b>	100 MΩ min. (at 250 VDC)				
<b>Dielectric strength</b>	500 VAC, 50/60 Hz for 1 minute				
<b>Bounce time</b>	5 ms max.				
<b>Vibration</b>	Malfunction durability: 10 to 55 Hz, 1.5 mm double amplitude				Malfunction: 10 to 55 Hz, 1.5 mm double amplitude for 30 to 60 s
<b>Shock</b>	Mechanical durability: 1,000 m/s <sup>2</sup> (approx. 100 G) Malfunction durability: 100 m/s <sup>2</sup> (approx. 10 G)				Destruction: 1,000 m/s <sup>2</sup> max.
<b>Ambient temperature</b>	-25° to 70°C (with no icing)				
<b>Humidity</b>	35% to 85% RH				35% to 85%

1. Denotes the weight of standard type.
2. Data shown are of initial value.

## ■ Life Expectancy

B3F-1000, B3F-3000, B3F-6000:
1,000,000 operations min (OF: 100gf) (B3F-1070: 500,000 operations min)
300,000 operations min (OF: 150 gf)
100,000 operations min (OF: 260gf)
B3F-G:
300,000 operations min (OF: 176gf)
B3F-4000:
3,000,000 operations min (OF: 1.28 N)
1,000,000 operations min (OF: 2.55 N)
B3F-5000:
10,000,000 operations min.

## ■ Operating Characteristics

Characteristics	Part Number						
	B3F-1□□□ / -3□□□		B3F-4□□□ / -5□□□		B3F-6□□□		B3F-1□□□-G
	General purpose type	High force type	General purpose type	High force type	General purpose type	High force type	General purpose type
<b>Operating force (OF)</b>	100 ± 30 g	150 ± 50 g	130 ± 50 g	260 ± 70 g	100 ± 30 g	150 ± 50 g	1.76 ± 0.49 N
<b>Release force (RF) min.</b>	20 g	50 g	30 g	50 g	20 g	50 g	0.49 N
<b>Pretravel (PT) max.</b>	0.25 <sup>+0.2</sup> / <sub>-0.1</sub> mm	0.25 <sup>+0.2</sup> / <sub>-0.1</sub> mm	0.3 <sup>+0.2</sup> / <sub>-0.1</sub> mm	0.3 <sup>+0.2</sup> / <sub>-0.1</sub> mm	0.25 <sup>+0.2</sup> / <sub>-0.1</sub> mm	0.25 <sup>+0.2</sup> / <sub>-0.1</sub> mm	0.25 <sup>+0.2</sup> / <sub>-0.1</sub> mm

**Construction**

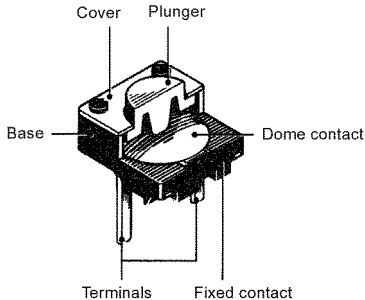

**B3F-1□□□-G**

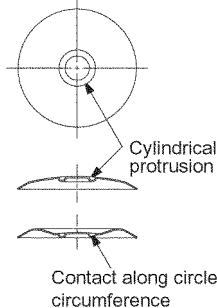

Contact along circle circumference (circular contact)

Switches have circular contact surface instead of single center point contact, increasing contact reliability.

**Contact Form**

**B3F-10□□**  
 -40□□  
 -50□□  
 -10□□-G

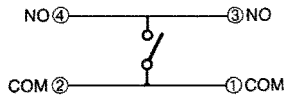

**B3F-11□□**  
 -41□□  
 -51□□  
 -11□□-G

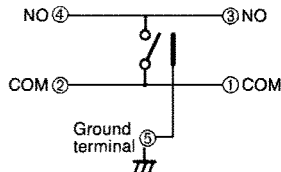

**B3F-3□□□**

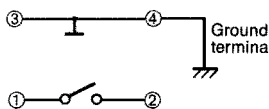

**Engineering Data**

**Operating Force vs. Stroke (typical example)**

**B3F-1□□□/-3□□□/-6□□□**

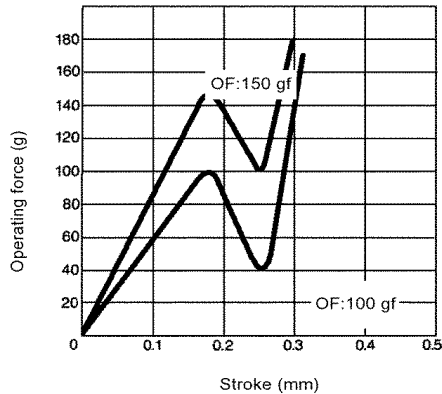

**B3F-4□□□/-5□□□**

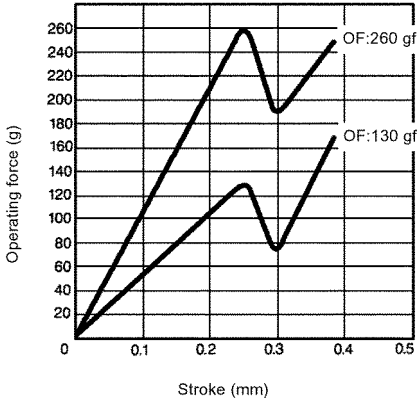

# Dimensions

Unit: mm (inch)

## ■ B3F-1000/-1002/-1005/-1020\*/-1022\*/-1025\*

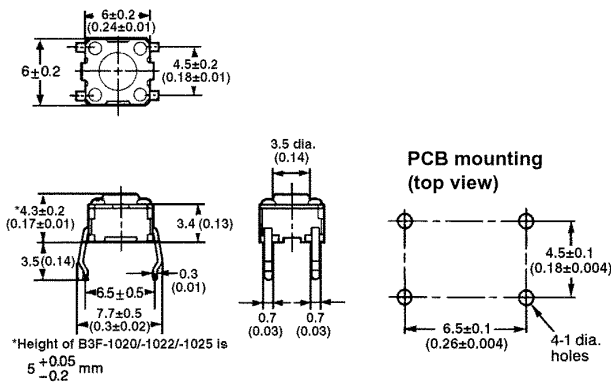

\*Height of B3F-1020/-1022/-1025 is  $5^{+0.05}_{-0.2}$  mm

## ■ B3F-1050/-1052/-1055

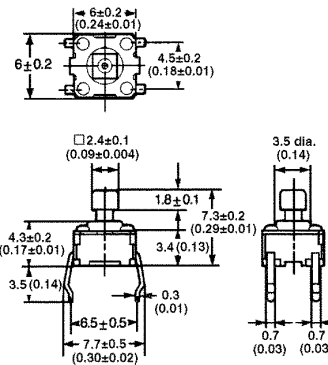

The height of the B3F-102□-G is  $5 \pm 0.2$  mm.

## ■ B3F-1100/-1102/-1105/-1120\*\*/-1122\*\*/-1125\*\*

## ■ B3F-1150/-1052/-1055

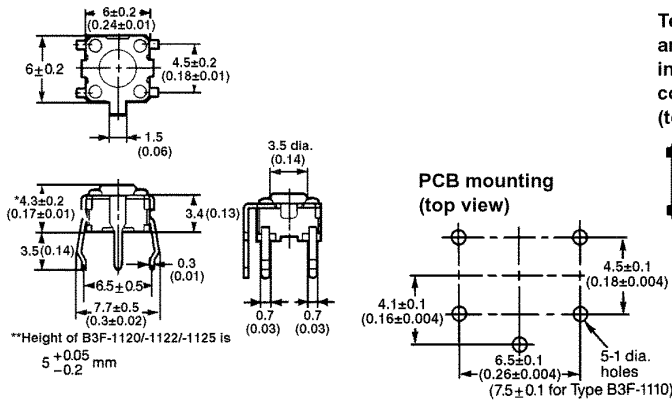

\*\*Height of B3F-1120/-1122/-1125 is  $5^{+0.05}_{-0.2}$  mm

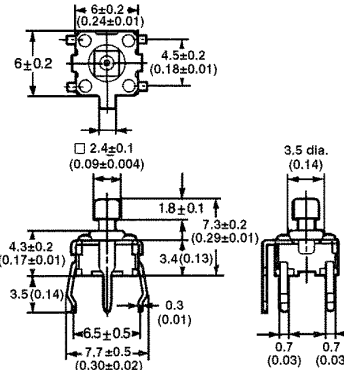

The height of the B3F-112□-G is  $5 \pm 0.2$  mm.

**Note:** Terminal numbers are not indicated on this switch. With the switch turned over so that the logo mark "OMRON" is visible on the upper part of the rear side of the switch base, the terminal on the right of the logo mark is numbered "1" and that on the bottom right is "3." Accordingly, two terminals on the left side are numbered "2" and "4" respectively.

**Note:** Unless otherwise specified, a tolerance of  $\pm 0.4$  mm applies to all dimensions.

## ■ B3F-1110

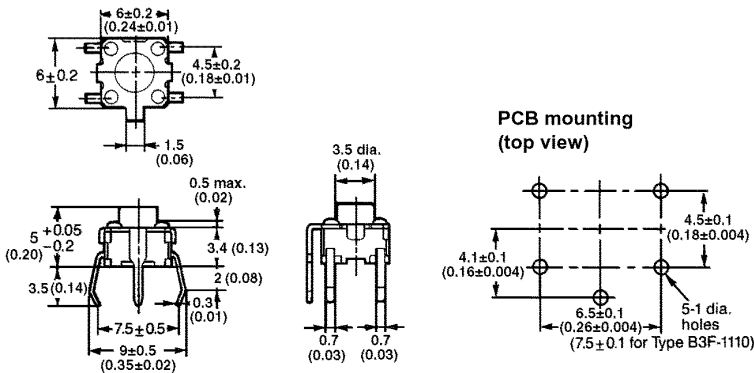

**Note:** Terminal numbers are not indicated on this switch. With the switch turned over so that the logo mark "OMRON" is visible on the upper part of the rear side of the switch base, the terminal on the right of the logo mark is numbered "1" and that on the bottom right is "3." Accordingly, two terminals on the left side are numbered "2" and "4" respectively.

Unit: mm (inch)

■ B3F-3100/-3102/-3105

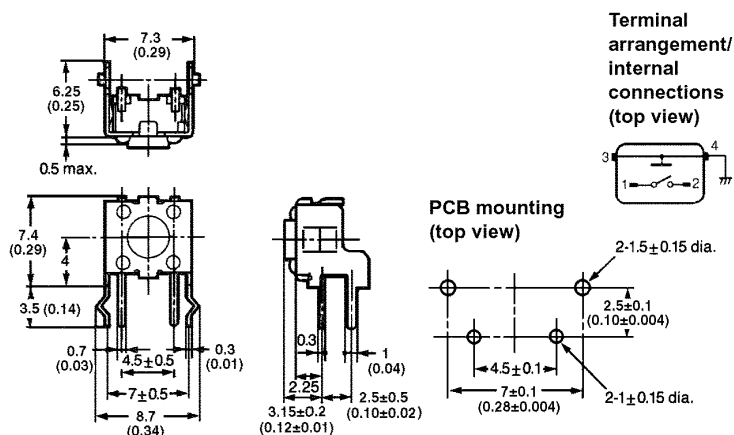

■ B3F-3150/-3152/-3155

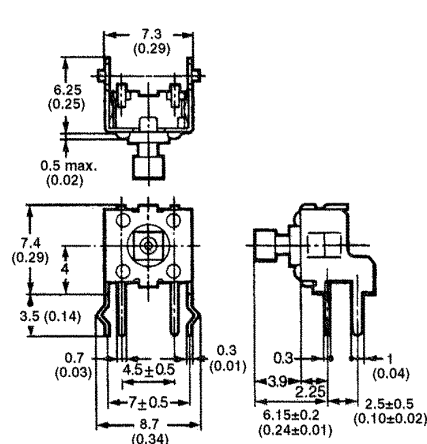

■ B3F-3120/-3122/-3125

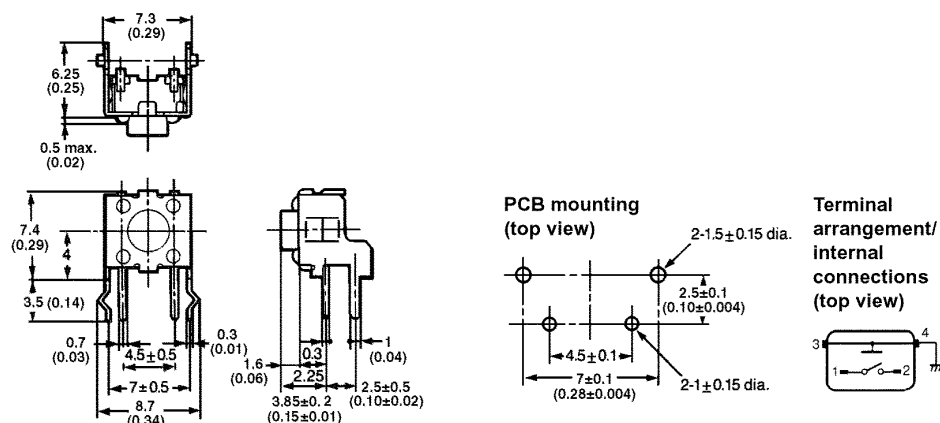

Note: Unless otherwise specified, a tolerance of ± 0.4 mm applies to all dimensions.

■ B3F-4000/-5000/-4005/-5001

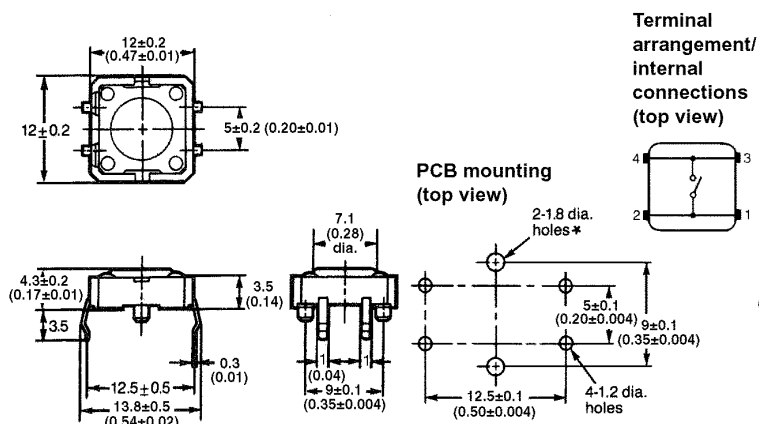

■ B3F-4050/-5050/-4055/-5051

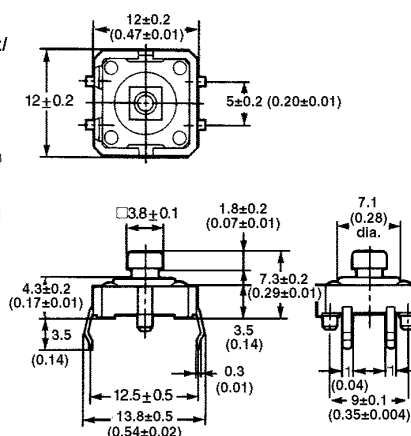

\* Fit the projection of the switch into this hole to secure the switch.

■ B3F-4101/-5100/-4105/-5101

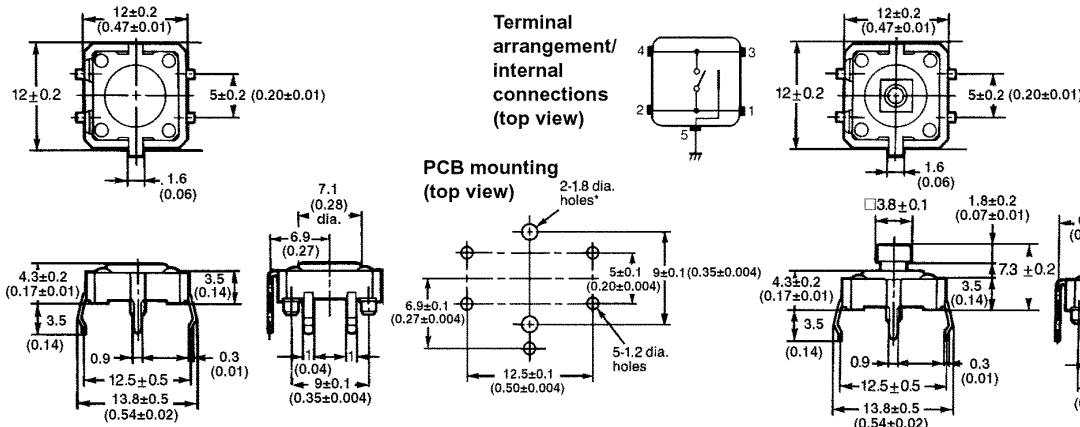

■ B3F-4150/-5150/-4155/-5151

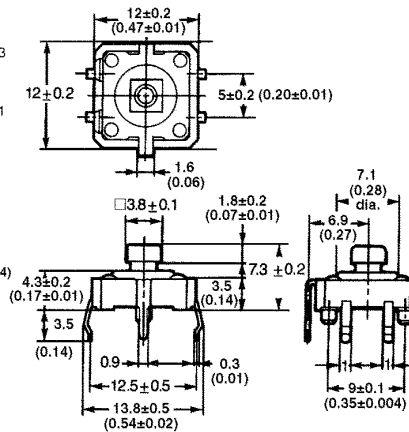

\* Fit the projection of the switch into this hole to secure the switch.

■ B3F-6000/-6002

■ Tape-Packaging Dimensions

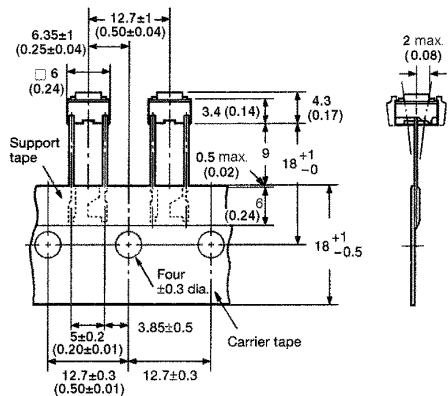
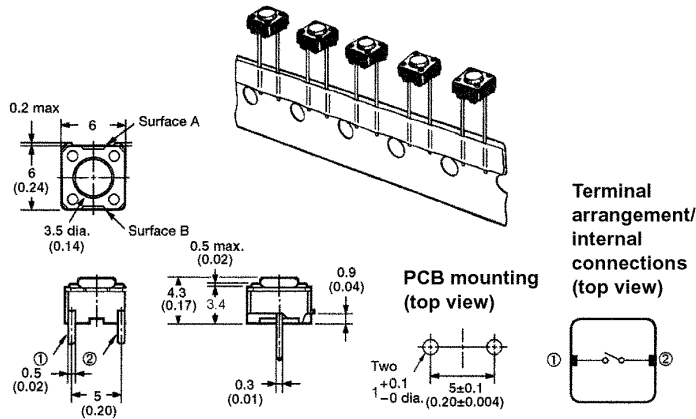

Note: The tape is random between surface A and surface B.

Unit: mm (inch)

■ B3F-6100/-6102

■ Tape-Packaging Dimensions

