

## AT600s

**AT602**  
**Incandescent Lamp**  
 Volts: 6 12 18 24 28  
 Series: LW MLW  
 T-1 1/2 Pilot Slide Base

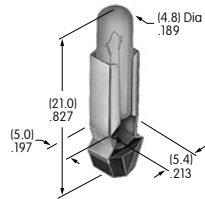

**AT602N**  
**Neon Lamp**  
 Volts: 110  
 Series: LW MLW  
 T-1 1/2 Pilot Slide Base

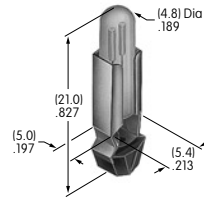

**AT604**  
**Incandescent Lamp**  
 Volts: 6 14 28  
 Series: DLB  
 T-1 3/4 Midget Groove Base

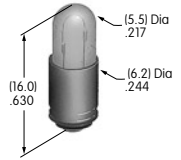

**AT604N**  
**Neon Lamp**  
 Volts: 110  
 Series: DLB  
 T-1 3/4 Midget Groove Base

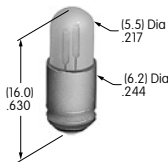

**AT607**  
**Incandescent Lamp**  
 Volts: 5 12  
 Series: LB  
 T-1 Bi-pin

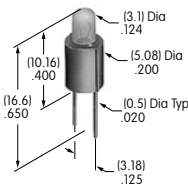

**AT607N**  
**Neon Lamp**  
 Volts: 110  
 Series: LB  
 T-1 Bi-pin

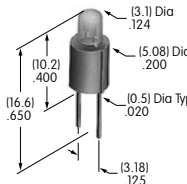

**AT611**  
**Incandescent Lamp**  
 Volts: 5 12  
 Series: KB YB  
 T-1 Bi-pin

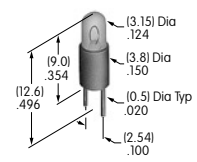

**AT615**  
**Neon Lamp**  
 Volts: 110  
 Series: KB  
 T-1 Bi-pin

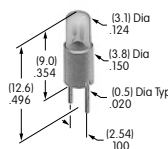

**AT617**  
**Single Element LED**  
 Colors: C E F  
 Used for AT212 Bezel

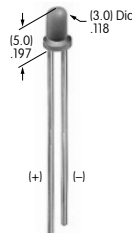

**AT618**  
**Single Element LED**  
 Colors: C E F  
 Used for AT213 Bezel

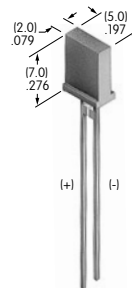

**AT621**  
**6-element Bicolor LED**  
 Colors: CF  
 Series: YB  
 T-1 1/2 Bi-pin

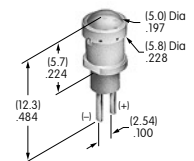

**Color Codes:** A Black B White C Red D Amber E Yellow F Green G Blue H Gray J Clear

**AT494**  
**Protective Guard**  
 Polycarbonate & polyamide  
 Series: KB

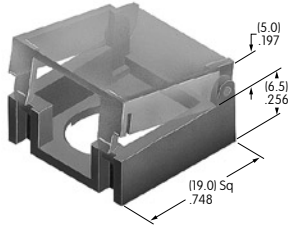

**AT495**  
**Dust Cover**  
 Polyamide & polyvinyl chloride  
 Series: KB

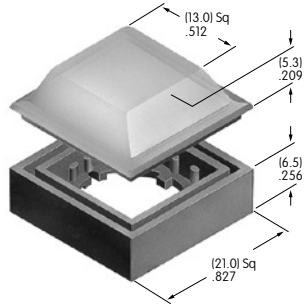

**AT496**  
**.295" Diameter Cap**  
 Polyamide  
 Colors: A B C  
 Series: AB BB FB M2B MB24



**AT497**  
**End Barrier**  
 Polyamide  
 Color: A  
 Series: LB

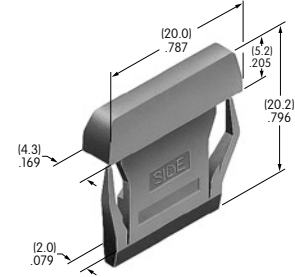

**AT498**  
**Center Barrier**  
 Polyamide  
 Color: A  
 Series: LB

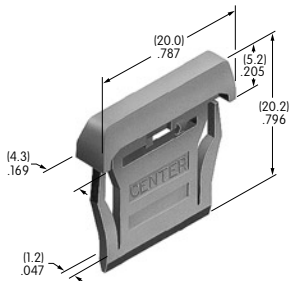

**AT499**  
**Protective Guard for Square**  
 Polycarbonate & polyamide  
 Series: LB

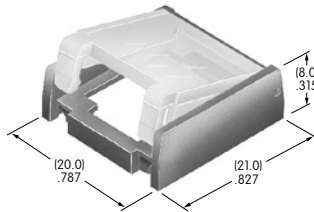

## AT500s

**AT501 (M-metric H-inch)**  
**Knurled Face Nut**  
 Chrome/brass  
 Series: E EB M MB20 MB24 P

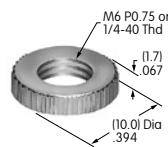

**AT503**  
**Hex Face Nut**  
 Chrome/brass  
 Series: M P S SB WB WT

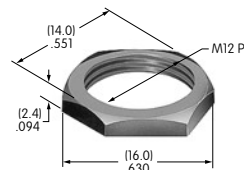

**AT504**  
**Knurled Face Nut**  
 Chrome/brass  
 Series: M P S SB WB WT

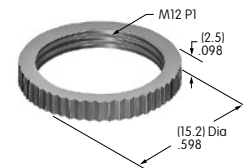

**Color Codes:** A Black B White C Red D Amber E Yellow F Green G Blue H Gray J Clear

## AT600s

**AT602**  
**Incandescent Lamp**  
 Volts: 6 12 18 24 28  
 Series: LW MLW  
 T-1 1/2 Pilot Slide Base

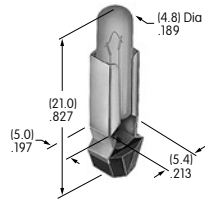

**AT602N**  
**Neon Lamp**  
 Volts: 110  
 Series: LW MLW  
 T-1 1/2 Pilot Slide Base

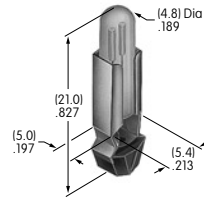

**AT604**  
**Incandescent Lamp**  
 Volts: 6 14 28  
 Series: DLB  
 T-1 3/4 Midget Groove Base

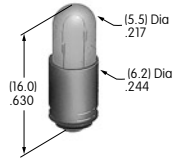

**AT604N**  
**Neon Lamp**  
 Volts: 110  
 Series: DLB  
 T-1 3/4 Midget Groove Base

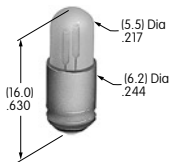

**AT607**  
**Incandescent Lamp**  
 Volts: 5 12  
 Series: LB  
 T-1 Bi-pin

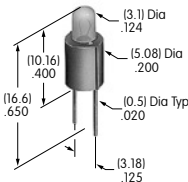

**AT607N**  
**Neon Lamp**  
 Volts: 110  
 Series: LB  
 T-1 Bi-pin

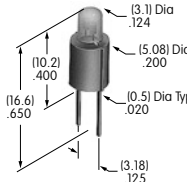

**AT611**  
**Incandescent Lamp**  
 Volts: 5 12  
 Series: KB YB  
 T-1 Bi-pin

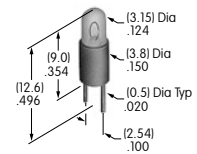

**AT615**  
**Neon Lamp**  
 Volts: 110  
 Series: KB  
 T-1 Bi-pin

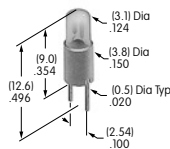

**AT617**  
**Single Element LED**  
 Colors: C E F  
 Used for AT212 Bezel

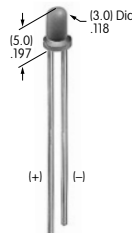

**AT618**  
**Single Element LED**  
 Colors: C E F  
 Used for AT213 Bezel

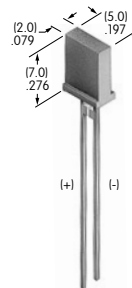

**AT621**  
**6-element Bicolor LED**  
 Colors: CF  
 Series: YB  
 T-1 1/2 Bi-pin

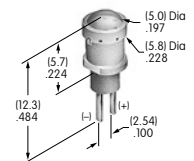

**Color Codes:** A Black B White C Red D Amber E Yellow F Green G Blue H Gray J Clear

**AT4041 (M-metric H-inch)**  
**Waterproof Boot for Momentary**  
 Silicone Rubber  
 Series: MB

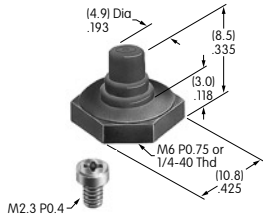

**AT4042 (M-metric H-inch)**  
**Waterproof Boot for Alternate**  
 Silicone Rubber  
 Series: MB

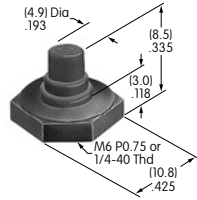

**AT4043**  
**Splashproof Boot**  
 Silicone Rubber  
 Series: MB SB WB

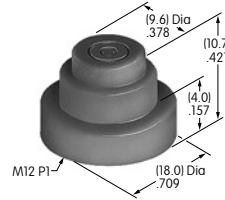

**AT4051**  
**Spot Illuminated Cap**  
 Polycarbonate  
 Colors: AB  
 Series: KB

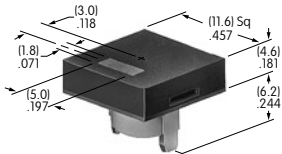

**AT4052**  
**Spot Illuminated Cap**  
 Polycarbonate  
 Colors: AB  
 Series: HB

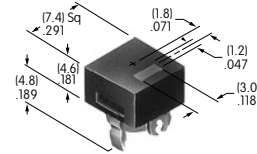

**AT4054**  
**Round Solid Colored Cap**  
 Polycarbonate  
 Colors: BJ CJ EJ FJ GJ  
 Series: LB Panel Seal

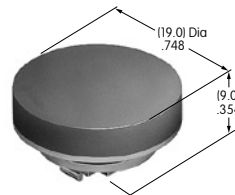

**AT4055**  
**Round Colored Insert Cap**  
 Polycarbonate  
 Colors: JB JC JE JF JG  
 Series: LB Panel Seal

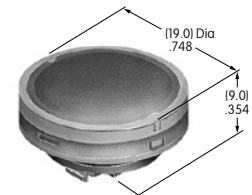

**AT4056**  
**Round Cap for LED**  
 Polycarbonate  
 Colors: JB JC JD JF  
 Series: LB Panel Seal

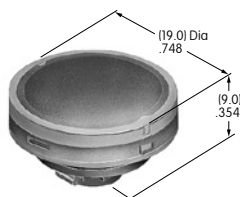

**AT4057**  
**Protective Guard for Rectangular**  
 Polycarbonate  
 Series: LB

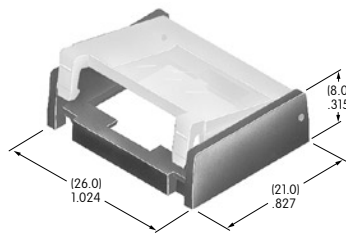

**AT4058**  
**Sculptured Cap**  
 Polyamide  
 Colors: A B C E F G H  
 Series: JB

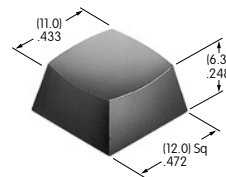

**AT4059**  
**Flat Cap**  
 Polycarbonate  
 Colors: A B C E F G H  
 Series: JB

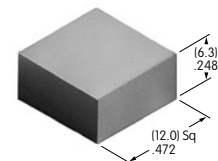

**Color Codes:** A Black B White C Red D Amber E Yellow F Green G Blue H Gray J Clear