

Distinctive Characteristics

Industry's first molded rocker with TV rating. Designed to handle large inrush current. JWM models certified for TV-5 rating and JWL models for TV-8 rating.

Special 5A @ 72V DC rating for JWL models to use in worldwide telecommunication equipment for power distribution applications.

Prominent external insulating barriers increase insulation resistance and dielectric strength.

Constructed for dust resistance with interior cover between actuator and contact area.

Specially designed to break light contact welds.

JWMW panel seal version meets IP67 of IEC60529 Standards (similar to NEMA 4 and 6).

Terminals are molded in and epoxy sealed to lock out flux, dust, and other contaminants.

Housing and case of heat resistant resin meet UL 94V-0 standard.

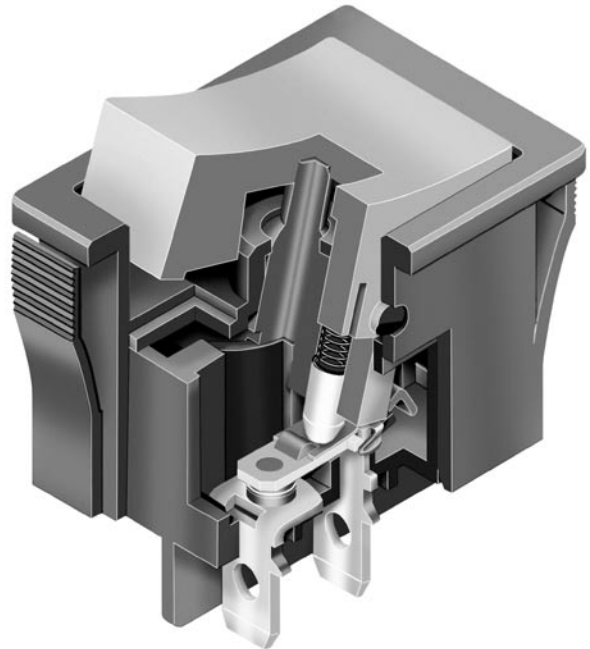

Actual Size JWM



General Specifications

Electrical Capacity (Resistive Load)

Power Level: 10A @ 125/250V AC for JWM & JWMW models; 10A @ 30V DC for JWMW;
16A @ 125/250V AC for JWL models; 5A @ 72V DC for telecommunication applications

Other Ratings

Contact Resistance: 10 milliohms maximum for JWM & JWMW; 20 milliohms maximum for JWL
Insulation Resistance: 1,000 megohms minimum @ 500V DC
Dielectric Strength: 2,000V AC minimum between contacts for 1 minute minimum;
4,000V AC minimum between contacts & case for 1 minute minimum
Mechanical Life: 25,000 operations minimum
Electrical Life: 25,000 operations minimum
Nominal Operating Force: JWM & JWMW Single Pole 3.92N & Double Pole 7.84N
JWL Single Pole 5.00N & Double Pole 10.00N
Angle of Throw: 26°

Materials & Finishes

Housing/Frame & Barrier:	Polyamide (UL94V-0)	Movable Contacts:	Silver alloy
Interior Seal for JWM & JWL:	Polyphenylene sulfide	Stationary Contacts:	Silver alloy
Case/Base:	Melamine (UL94V-0)	Terminals:	Brass with silver plating

Environmental Data

Operating Temp Range: -25°C through +70°C (-13°F through +158°F) for JWM & JWL;
-25°C through +85°C (-13°F through +185°F) for panel seal JWMW model
Humidity: 90 ~ 95% humidity for 96 hours @ 40°C (104°F)
Vibration: 10 ~ 55Hz with peak-to-peak amplitude of 1.5mm traversing the frequency range
& returning in 1 minute; 3 right angled directions for 2 hours
Shock: 50G (490m/s²) acceleration (tested in 6 right angled directions, with 5 shocks in each direction)
Sealing: IP67 of IEC60529 standard for panel seal JWMW model; dust resistant inner seal for others.

Installation

Soldering Time & Temp: Manual Soldering: See Profile A in Supplement section.

Standards & Certifications

Flammability Standards: UL94V-0 for housing/frame & case/base of JWL, JWM, & JWMW models
TV Ratings for UL & CSA: JWM & JWMW (TV-5) Overload Test @ 120V AC for 50 operations:
Steady State Current (rms) 7.5A; Minimum Inrush Current (peak) 111A
JWM & JWMW (TV-5) Endurance Test @ 120V AC for 25,000 operations:
Steady State Current (rms) 5A; Minimum Inrush Current (peak) 78A
JWL (TV-8) Overload Test @ 120V AC for 50 operations:
Steady State Current (rms) 12A; Minimum Inrush Current (peak) 163A
JWL (TV-8) Endurance Test @ 120V AC for 25,000 operations:
Steady State Current (rms) 8A; Minimum Inrush Current (peak) 117A
UL & C-UL Recognized: JWM & JWMW models recognized at 10A @ 250V AC & JWMW at 10A @ 30V DC;
JWL models recognized at 16A @ 250V AC; 5A @ 72V DC (specify "/U-DC" after part number to request UL rating be marked on DC rated switches);
UL File No. WOYR2.E44145; C-UL File No. WOYR8.E44145.
CSA Certified: JWM & JWMW models certified at 10A @ 250V AC;
JWL models certified at 16A @ 250V AC; CSA File No. 023535-0-000
VDE Approved: JWM models approved at steady state 5A, inrush 80A, resistive 10A, & motor load 6A all at 250V AC; VDE License No. 115637; JWL models approved at steady state 8A, inrush 128A, resistive 16A, & motor load 8A all at 250V AC; VDE License No. 115637.
 Note: JWM & JWL Double Pole, Single Throw models approved only with the international on-off symbols on the actuator.

TYPICAL SWITCH ORDERING EXAMPLE

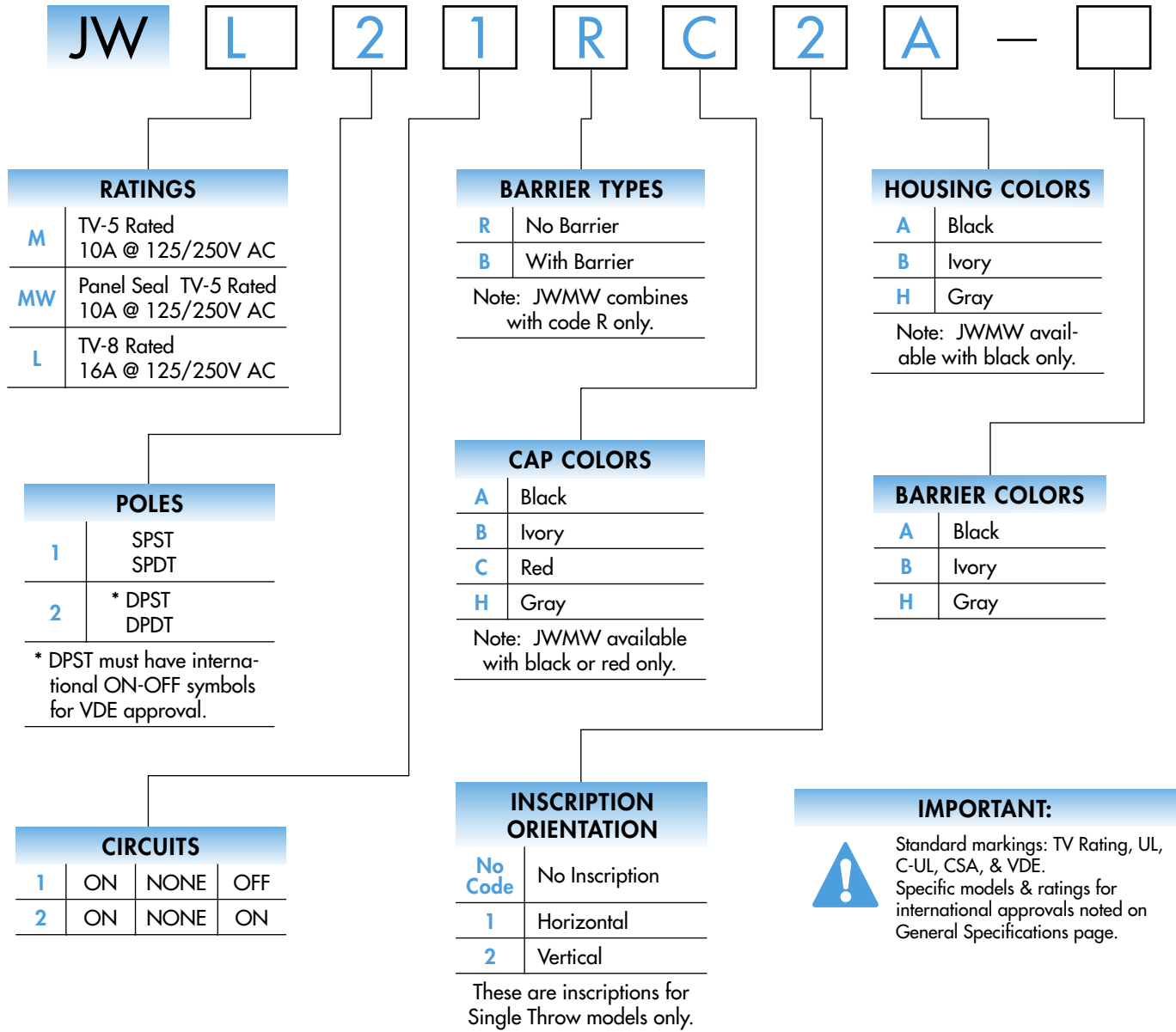

DESCRIPTION FOR TYPICAL ORDERING EXAMPLE

JWL21RC2A

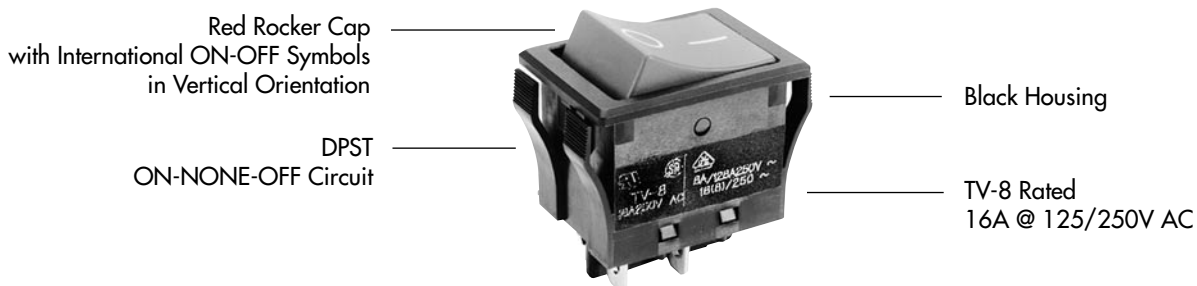

RATINGS

M

TV-5 Rated

Power Level

10A @ 125/250V AC

MW

Panel Seal TV-5 Rated

Power Level

10A @ 125/250V AC

L

TV-8 Rated

Power Level

16A @ 125/250V AC

POLES & CIRCUITS

Pole	Model	Rocker Position			Connected Terminals			Throw & Schematics
		Down	Center	Up	Down	Center	Up	
SP	JWM11 JWMW11 JWL11	ON	NONE	OFF	1-1b	OPEN	OPEN	SPST
SP	JWM12 JWMW12 JWL12	ON	NONE	ON	1-1b	OPEN	1-1α	SPDT
DP	JWM21 JWMW21 JWL21	ON	NONE	OFF	1-1b 2-2b	OPEN	OPEN	DPST
DP	JWM22 JWMW22 JWL22	ON	NONE	ON	1-1b 2-2b	OPEN	1-1α 2-2α	DPDT

BARRIER TYPES & COLORS

R

No Barrier

Flange/Housing Material: Polyamide
Finish: Matte



JWM

JWL

No-barrier type has a flat flange which is an integral part of the switch.

JWMW panel seal device has exterior seal of acrylonitrile butadiene rubber covering the flange.

B

With Barrier

Barrier Material: Polyamide
Finish: Matte



JWM

JWL

Barrier type designates that either AT217 (for JWM) or AT218 (for JWL) is factory assembled. Dimensions for barriers are shown in the Accessories section.

Barrier Colors Available:

A

Black

B

Ivory

H

Gray

CAP COLORS



Cap Material:
Polyphenelene Oxide

Finish: Matte

Rocker cap is an integral part of the switch and not available separately.
JWMW available with black or red caps only.

Cap Colors Available:



Black



Ivory



Red



Gray

INSCRIPTIONS

No Code

No Inscription

1

Inscription for Horizontal Mounting

2

Inscription for Vertical Mounting



DPST models without inscriptions do not have VDE approval.

The IEC symbols for On-Off are supplied with Single Throw models only.
Orientation of inscription must be selected.
Inscription Colors: Black ink on Ivory or Gray cap. White ink on Black or Red cap.
Contact factory for other inscriptions.

HOUSING

Material: Polyamide

Finish: Matte

Colors Available:



Black



Ivory



Gray

JWMW panel seal models available in black housing only.

TERMINALS

Solder Lug/.110" (2.8mm) Quick Connect

Solder Lug/.187" (4.75mm) Quick Connect

JWM & JWMW

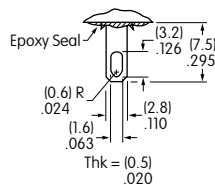

JWL

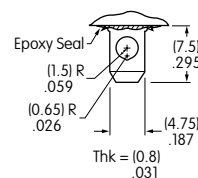

This switch assembly with connectors is not UL, C-UL, CSA, or VDE approved.

TYPICAL SWITCH DIMENSIONS

TV-5 No Barrier • 10 Amp

Single & Double Pole



JWM11RC1A

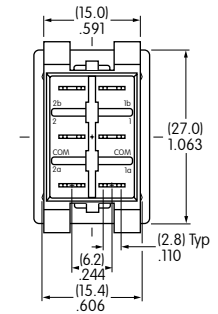
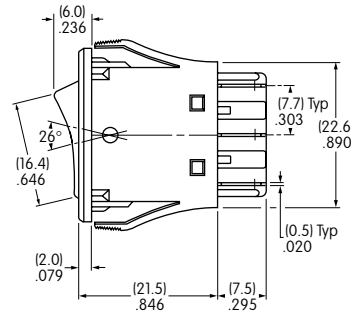
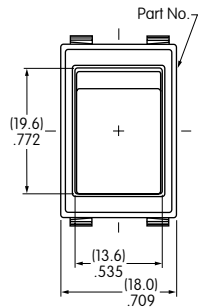

TV-5 With Barrier • 10 Amp

Single & Double Pole



JWM11BCA-H

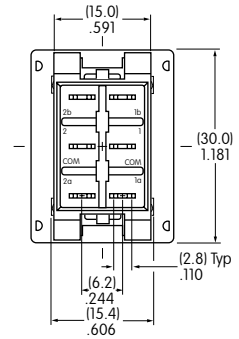
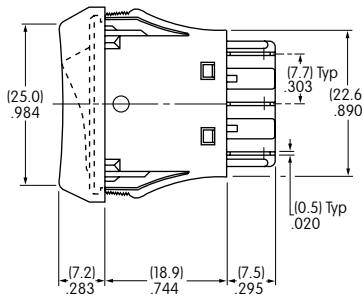
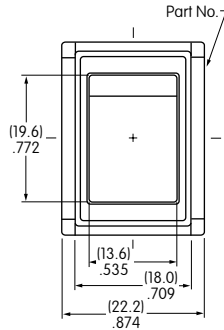

Panel Seal • TV-5 No Barrier • 10 Amp

Single & Double Pole



JWMW22RCA

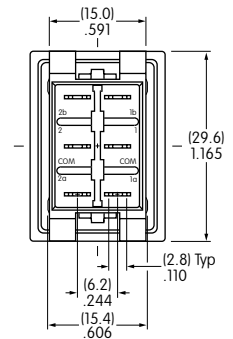
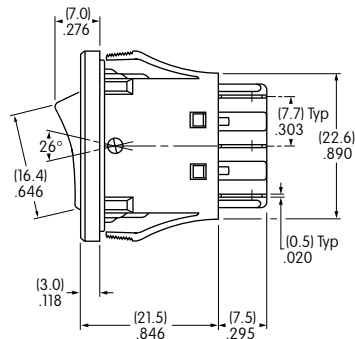
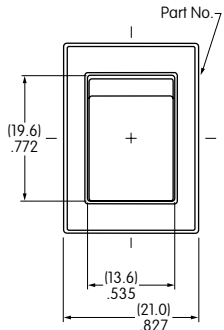

Single pole double throw models do not have terminals 2a, 2, & 2b; single throw models do not have 1a & 2a.

PANEL CUTOUTS FOR JWM MODELS

Panel Thickness Range

Without Barrier (JWM & JWMW):
.039" ~ .157" (1.0mm ~ 4.0mm)

With Barrier (JWM):
.024" ~ .126" (0.6mm ~ 3.2mm)

JWM

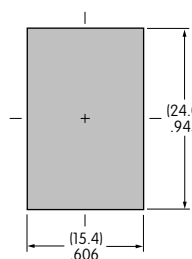

JWMW

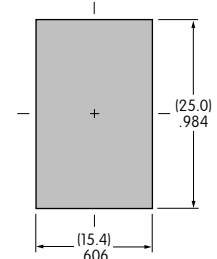

TYPICAL SWITCH DIMENSIONS

TV-8 No Barrier • 16 Amp

Single & Double Pole

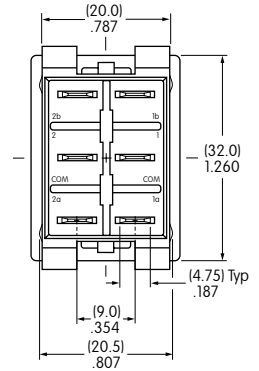
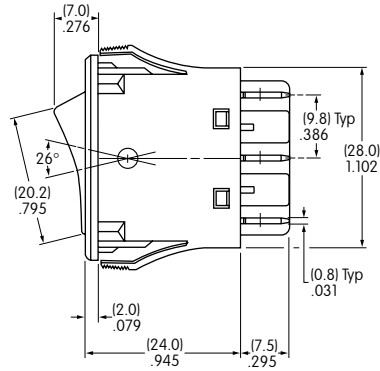
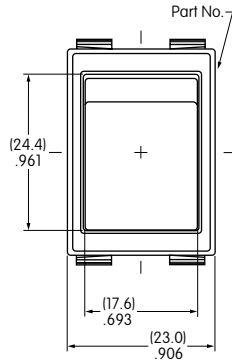

JWL21RC2A

Single pole double throw models do not have terminals 2a, 2, & 2b; single throw models do not have 1a & 2a.

TV-8 With Barrier • 16 Amp

Single & Double Pole

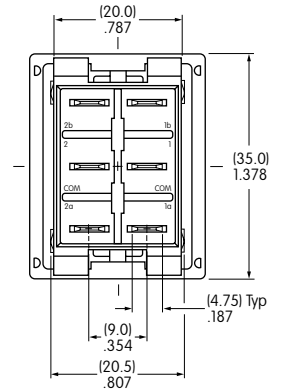
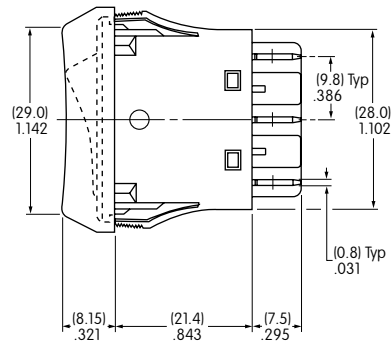
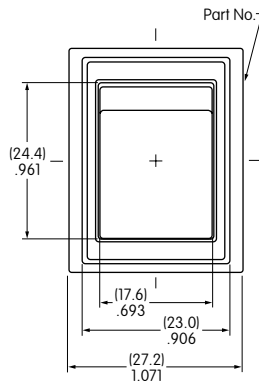

JWL11BCA-H

Single pole double throw models do not have terminals 2a, 2, & 2b; single throw models do not have 1a & 2a.

PANEL CUTOUT FOR JWL MODELS

Panel Thickness Range

Without Barrier:
.039" ~ .157" (1.0mm ~ 4.0mm)

With Barrier:
.024" ~ .126" (0.6mm ~ 3.2mm)

