

Distinctive Characteristics

Three methods of panel mounting: flat frame for flush with face or subpanel, snap-in, and PCB.

High insulating barriers increase isolation of circuits in multipole devices and provide added protection to contact points.

The molded diallyl phthalate case has a UL 94V-0 flammability rating.

Epoxy sealed terminals prevent entry of solder flux and other contaminants.

Prominent external insulating barriers increase insulation resistance and dielectric strength.

Bias guard prevents misalignment of contacts; interlocking of actuator block with rocker and internal guide does not allow transmission of diagonal force on rocker to reach contact mechanism.

Clinching of the frame to the case well above the base and terminals provides 1,500V dielectric strength.

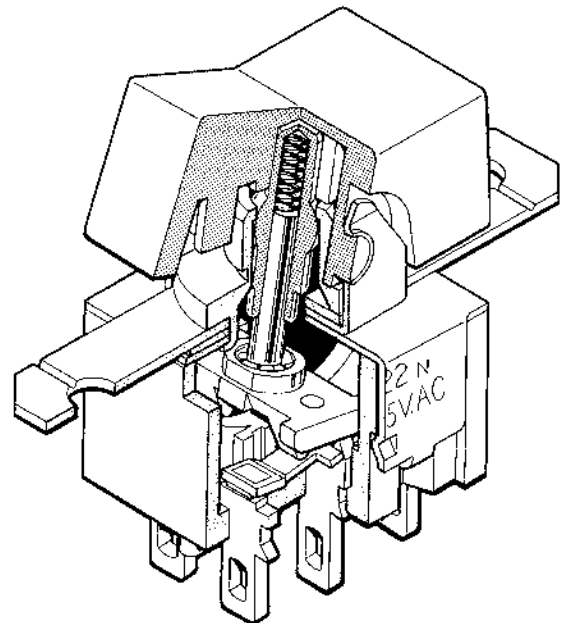

Actual Size

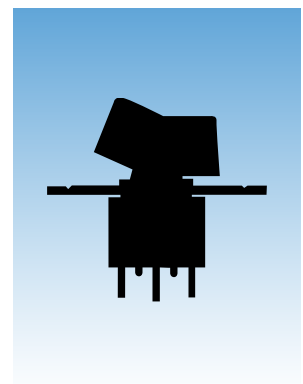

General Specifications

Electrical Capacity (Resistive Load)

- Power Level (code W):** 6A @ 125V AC & 3A @ 250V AC
4A @ 30V DC for On-None-On; 3A @ 30V DC for all other circuits
- Logic Level (code G):** 0.4VA maximum @ 28V AC/DC maximum
(Applicable Range 0.1mA ~ 0.1A @ 20mV ~ 28V)
- Logic/Power Level (code A):** Combines W & G ratings
Note: Find additional explanation of dual rating & operating range in Supplement section.

Other Ratings

- Contact Resistance:** 10 milliohms maximum for silver; 20 milliohms maximum for gold
- Insulation Resistance:** 1,000 megohms minimum @ 500V DC
- Dielectric Strength:** 1,000V AC minimum between contacts for 1 minute minimum;
1,500V AC minimum between contacts and case for 1 minute minimum
- Mechanical Life:** 50,000 operations minimum
- Electrical Life:** 25,000 operations minimum for silver; 50,000 operations minimum for gold;
50,000 operations minimum for silver at 3A @ 125V AC
- Angle of Throw:** 25°

Materials & Finishes

- Actuator Clip & Mounting Frame:** Stainless Steel
- Body Frame:** Stainless steel
- Case:** Diallyl phthalate resin (UL94V-0)
- Movable Contact:** Phosphor bronze with silver or gold plating
- Movable Contacts:** Silver alloy (code W); copper with gold plating (code G); or silver alloy with gold plating (code A)
- Stationary Contacts:** Silver with silver plating (code W); copper or brass with gold plating (code G); or silver with gold plating (code A)
- Terminals:** Copper or brass with silver plating; or copper or brass with gold plating

Environmental Data

- Operating Temp Range:** -30°C through +85°C (-22°F through +185°F)
- Humidity:** 90 ~ 95% humidity for 96 hours @ 40°C (104°F)
- Vibration:** 10 ~ 55Hz with peak-to-peak amplitude of 1.5mm traversing the frequency range & returning in 1 minute; 3 right angled directions for 2 hours
- Shock:** 50G (490m/s²) acceleration (tested in 6 right angled directions, with 5 shocks in each direction)

Processing

- Soldering:** Manual Soldering: 3 seconds maximum @ 350°C maximum
Wave Soldering: 5 seconds maximum @ 270°C maximum
All gold rated switches to be the following:
Manual Soldering: 4 seconds maximum @ 410°C maximum
Wave Soldering: See Profile A in Supplement section.
- Cleaning:** These devices are not process sealed. Hand clean locally using alcohol based solution. See Cleaning Specifications in Supplement section.

Standards & Certifications

- Flammability Standards:** UL94V-0 for case
- UL Recognized:** All models recognized at 6A @ 125V AC or 3A @ 250V AC or 0.4VA maximum @ 28V DC maximum; UL File No. WOYR2.E44145; add "/U" to end of part number to order UL mark on switch.
- CSA Certified:** All models recognized at 6A @ 125V AC or 3A @ 250V AC or 0.4VA maximum @ 28V maximum; CSA File No. 023535-0-000; add "/C" to end of part number to order CSA mark on switch.



TYPICAL SWITCH ORDERING EXAMPLE

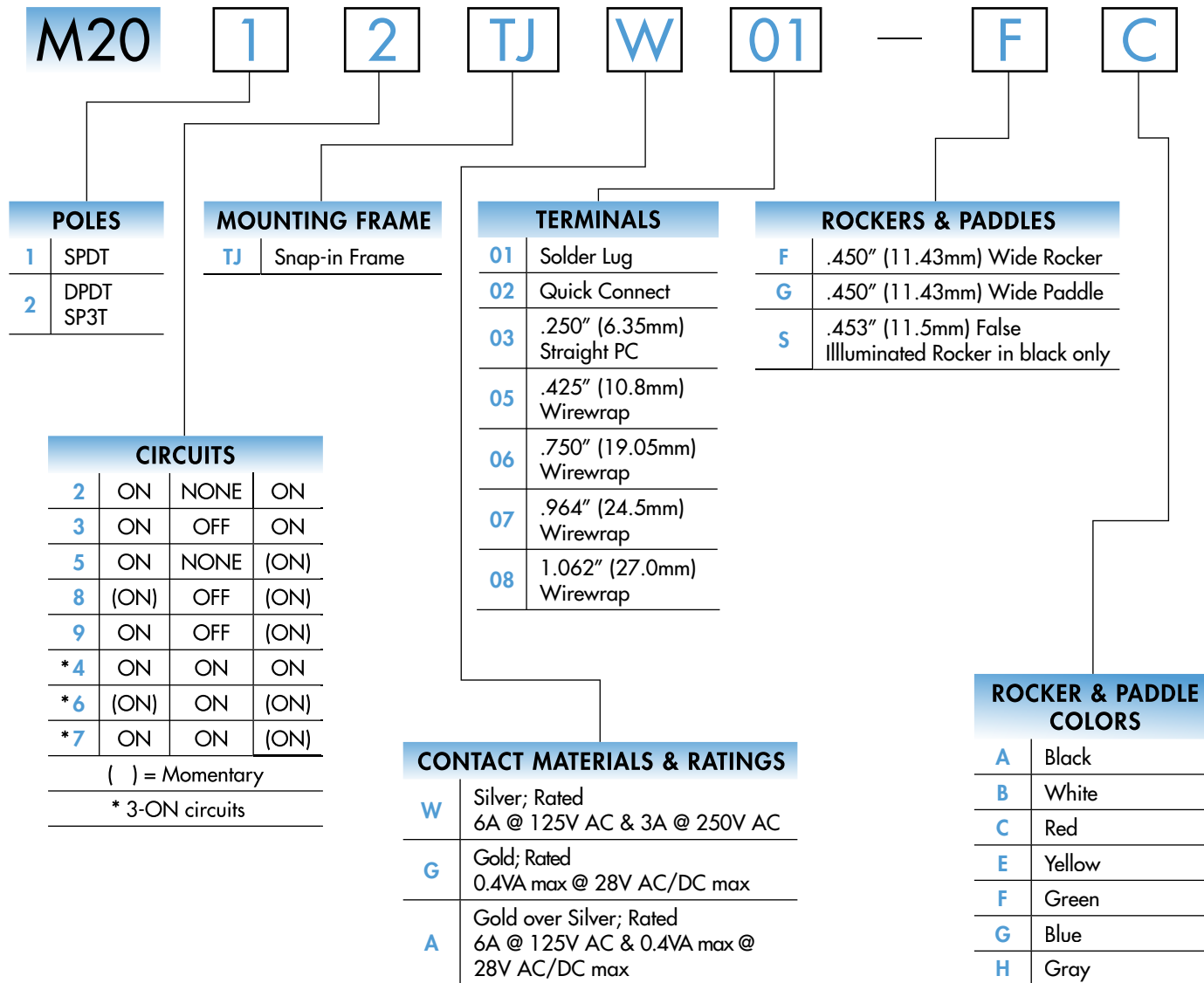

DESCRIPTION FOR TYPICAL ORDERING EXAMPLE

M2012TJW01-FC-1A

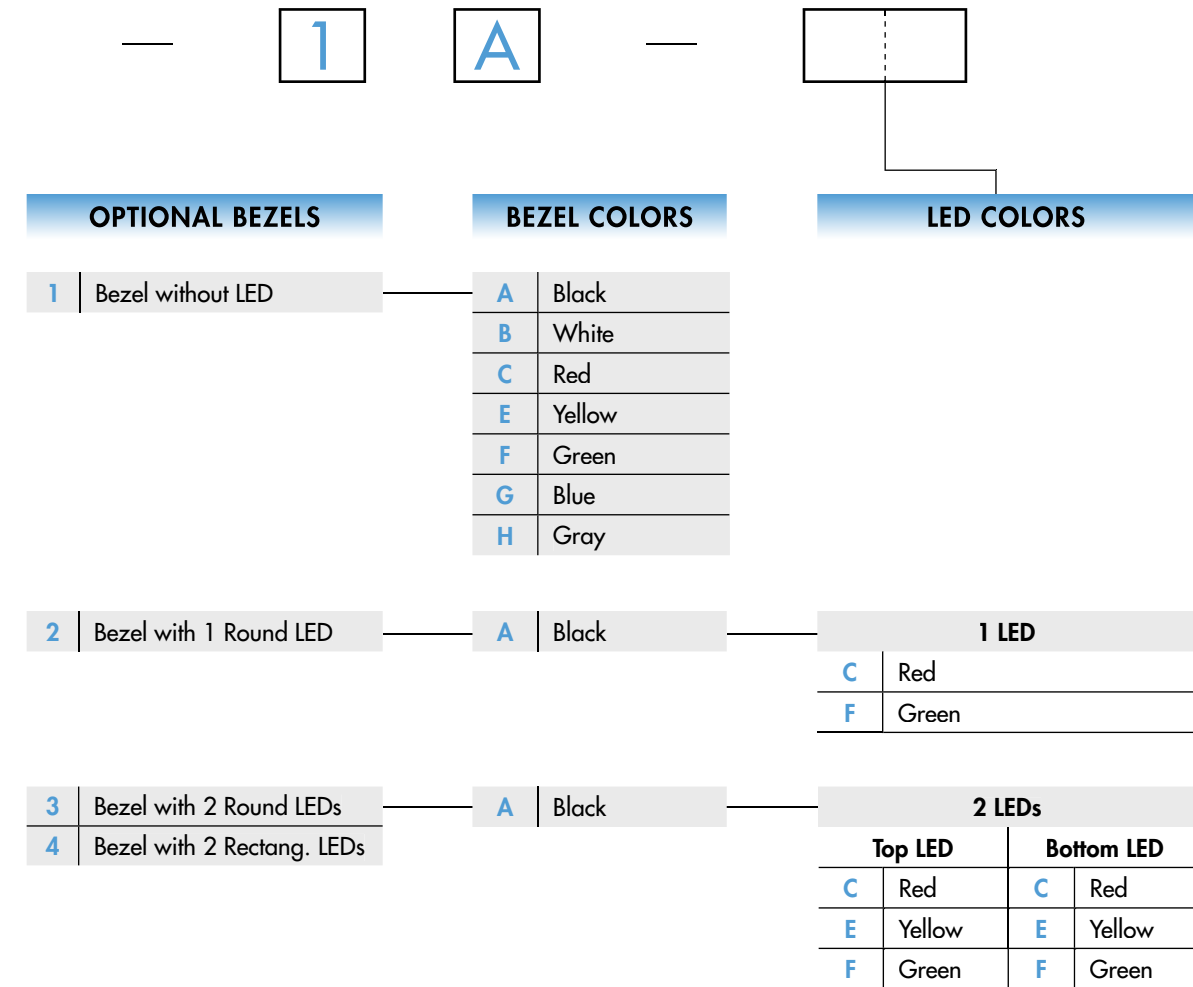
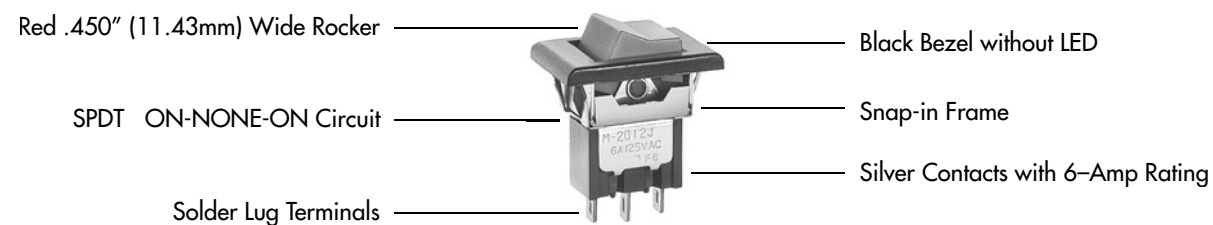

IMPORTANT:



Switches are supplied without UL & CSA marking unless specified. Specific models & ratings noted on General Specifications page.

DESCRIPTION FOR TYPICAL ORDERING EXAMPLE

M2012TJW01-FC-3A-CF

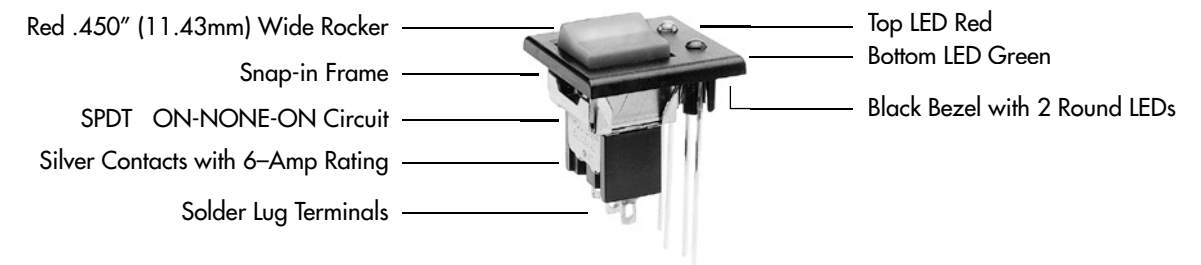

POLES & CIRCUITS

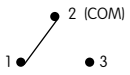
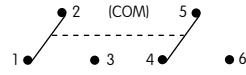
Pole	Model	Rocker Position () = Momentary			Connected Terminals			Throw & Schematics
		Down	Center	Up	Down	Center	Up	
SP	M2012 M2013 M2015 M2018 M2019	ON ON ON (ON) ON	NONE OFF NONE OFF OFF	ON ON (ON) (ON) (ON)	2-3	OPEN	2-1	Note: Terminal numbers are not actually on the switch. SPDT 
DP	M2022 M2023 M2025 M2028 M2029	ON ON ON (ON) ON	NONE OFF NONE OFF OFF	ON ON (ON) (ON) (ON)	2-3 5-6	OPEN	2-1 5-4	DPDT 

For 3 Throw (3-On)

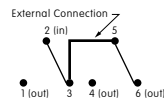
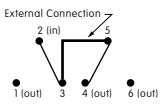
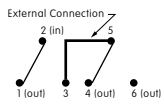
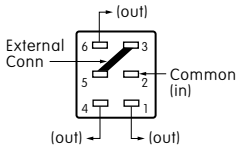
Pole	Model	Connected Terminals & Schematic			External Connection
		Down	Center	Up	
SP	M2024 M2026 M2027	ON (ON) ON  2-3 5-6	ON ON ON  2-3 5-4	ON (ON) (ON)  2-1 5-4	The SP3T model utilizes a double pole base. External connection must be made during field installation. 

MOUNTING FRAME

TJ

Snap-in Frame

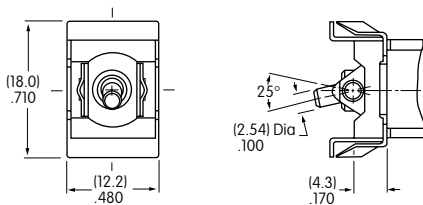

Panel Cutout for Single Pole without Bezel

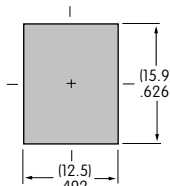

Panel Cutout for Double Pole without Bezel

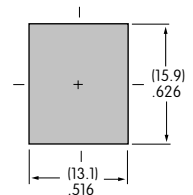

Panel Thickness without Bezel: .039" ~ .126" (1.0mm ~ 3.2mm)
Panel Thickness with Bezel: .039" ~ .098" (1.0mm ~ 2.5mm)

CONTACT MATERIALS & RATINGS

W

Silver over Silver

Power Level

6A @ 125V AC & 3A @ 250V AC

G

Gold over Brass or Copper

Logic Level

0.4VA maximum @ 28V AC/DC maximum

Note: See Supplement section to find complete explanation of operating range.

A

Gold over Silver

Power Level
or Logic Level

6A @ 125V AC
or 0.4VA maximum @ 28V AC/DC maximum

Note: This dual rated option is suitable when two or more identical switches are used in logic and in power circuits within the same application. See Supplement section to find complete explanation of dual rating and operating range.

TERMINALS

01 Solder Lug

The .043" x .079" (1.1mm x 2.0mm) oblong hole accommodates 1 solid 18-gauge wire or 2 solid or stranded 20-gauge wires.

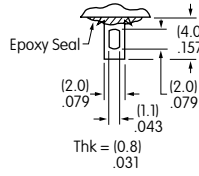

02 .062" (1.57mm) Wide Quick Connect

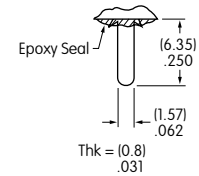

03 .250" (6.35mm) Straight PC

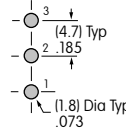
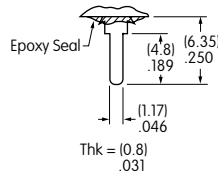

Single Pole

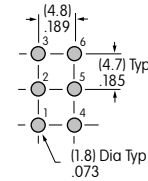

Double Pole

05 .425" (10.8mm) Wirewrap or Extended PC

06 .750" (19.05mm) Wirewrap or Extended PC

07 .964" (24.5mm) Wirewrap or Extended PC

08 1.062" (27.0mm) Wirewrap or Extended PC

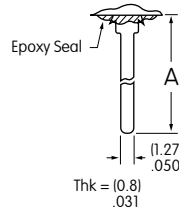

If using as extended PC terminal, refer to the above footprints.

Dimension A = terminal lengths as shown beside the terminal codes at the left.

ROCKERS & PADDLES

F AT4150 .450" (11.43mm) Wide Rocker

Material: Polyamide
Finish: Matte

Colors Available:
A, B, C, E, F, G, H

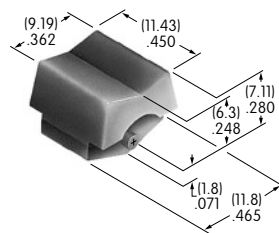

G AT4151 .450" (11.43mm) Wide Paddle

Material: Polyamide
Finish: Matte

Colors Available:
A, B, C, E, F, G, H

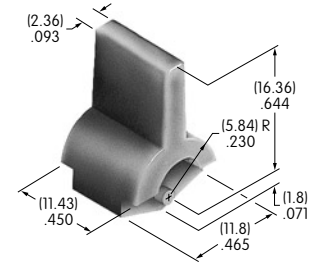

S AT466 .453" (11.5mm) False Illuminated Rocker

	<u>Rocker</u>	<u>False Illuminator</u>
Material:	Polycarbonate	Acrylonitrile Butadiene Styrene
Finish:	Glossy	
Colors:	Black	White and Red

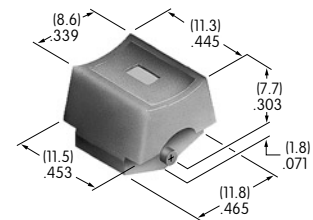

When a bezel is selected with AT466, glossy polycarbonate AT207 is supplied.

Cap Colors Available:



OPTIONAL SNAP-IN BEZELS & BEZEL COLORS

1 AT2107 Bezel

Material: Polyamide
Finish: Matte

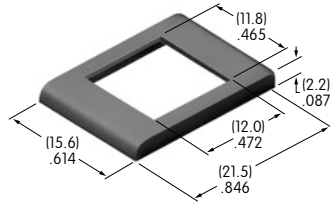

- | | |
|-----------------|----------------|
| A Black | F Green |
| B White | G Blue |
| C Red | H Gray |
| E Yellow | |

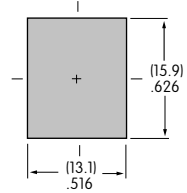

2 AT208 Bezel for AT070 LED

Material: Polycarbonate

Finish: Glossy

Contact factory for matte finish.

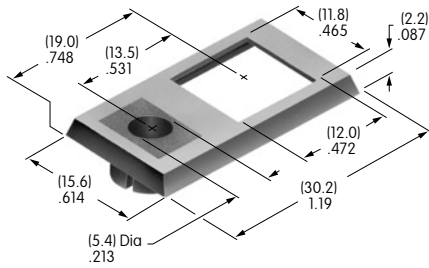

- A** Black

LED colors & specifications on next page.

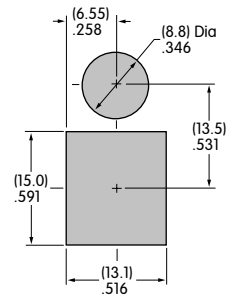

3 AT212 Bezel for AT617 LED

Material: Polycarbonate

Finish: Semi-glossy

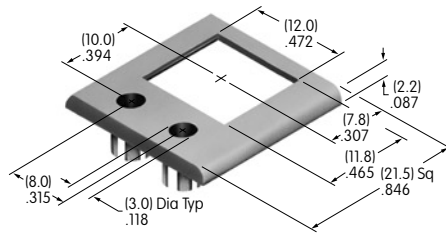

- A** Black

LED colors & specifications on next page.

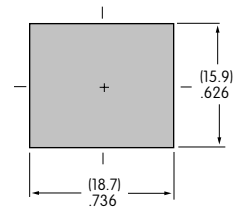

4 AT213 Bezel for AT618 LED

Material: Polycarbonate

Finish: Semi-glossy

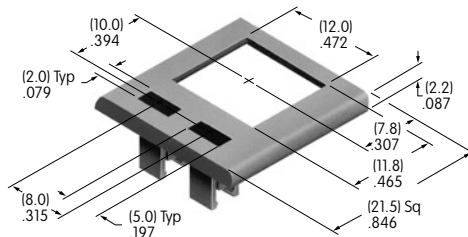

- A** Black

LED colors & specifications on next page.

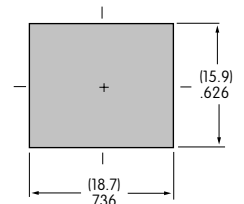

Bezel Assembly

1. Pry out tab on bezel to a 45° angle.

2. Insert switch frame under tab and snap on bezel.

3. Push tab back into place.

4. Snap assembled bezel and switch into panel.

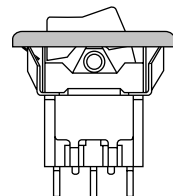
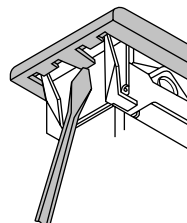
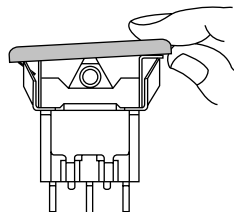
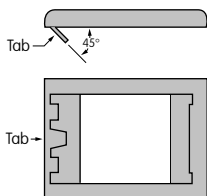

LED COLORS & SPECIFICATIONS

Bezel Orientation on Switch

AT070 LED
For Bezel AT208
with 1 LED

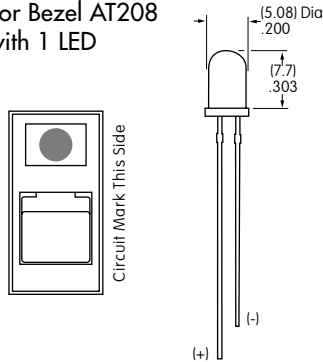

AT617 LED
For Bezel AT212
with 2 Round LEDs

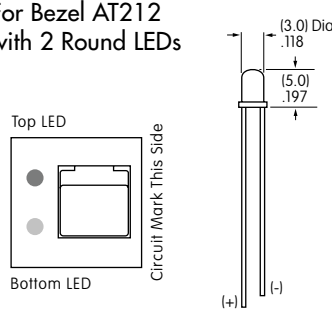

AT618 LED
For Bezel AT213
with 2 Rectangular LEDs

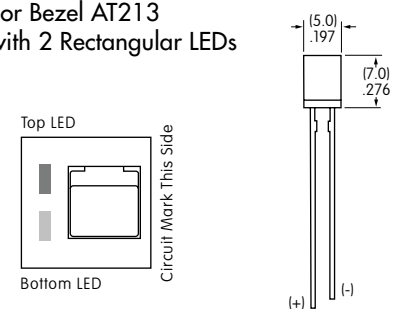

Note: Lead lengths may differ from manufacturing lot to lot. The longer lead is the anode (+).

		AT070		AT617			AT618		
		C	F	C	E	F	C	E	F
	Color	Red	Green	Red	Yellow	Green	Red	Yellow	Green
Forward Peak Current	I_{FM}	25mA	50mA	30mA	30mA	30mA	10mA	30mA	30mA
Continuous Forward Current	I_F	20mA	30mA	24mA	24mA	24mA	8mA	24mA	24mA
Forward Voltage	V_F	2.8V	2.1V	2.0V	2.0V	2.1V	1.9V	2.0V	2.1V
Reverse Peak Voltage	V_{RM}	4V	5V	5V	5V	5V	5V	5V	5V
Current Reduction Rate Above 25°C	ΔI_F	0.33 mA/°C	0.40 mA/°C	0.40 mA/°C	0.40 mA/°C	0.40 mA/°C	0.13 mA/°C	0.40 mA/°C	0.40 mA/°C
Ambient Temperature Range (when used with a bezel)		-10° ~ +70°C		-15° ~ +70°C			-15° ~ +70°C		

The electrical specifications shown are determined at a basic temperature of 25°C.
LED circuit is independent of switch operation. LED is colored in OFF state.

If the source voltage is greater than the rated voltage of the LED, a ballast resistor must be connected in series with the lamp.
The ballast resistor calculation and more lamp detail are shown in the Supplement section.

TYPICAL SWITCH DIMENSIONS

Snap-in Frame • Solder Lug

Single Pole

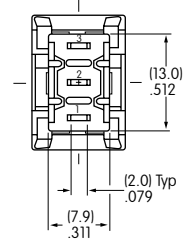
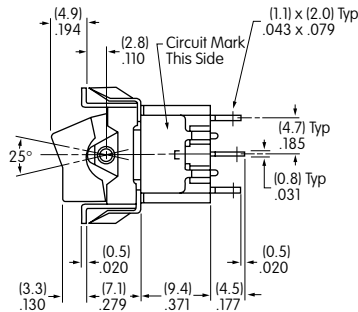
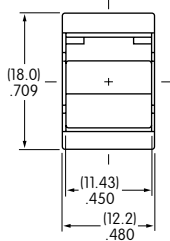

M2012TJW01-FC

Snap-in Frame • Solder Lug

Double Pole

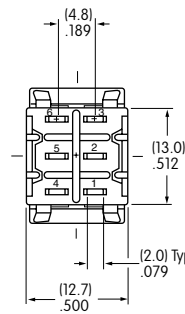
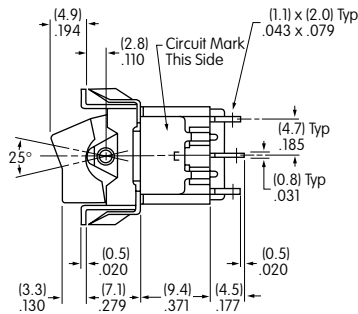
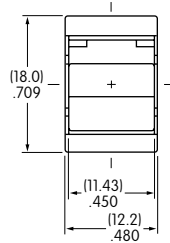

M2022TJW01-FC

Snap-in Frame • Solder Lug

Single Pole

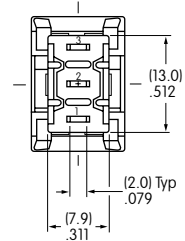
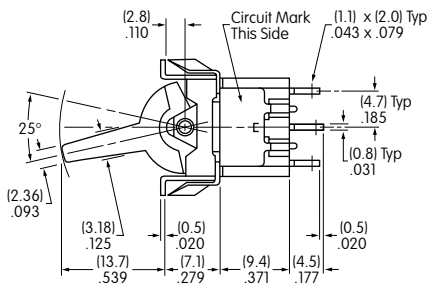
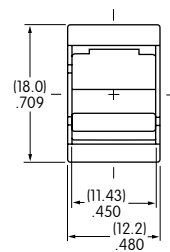

M2012TJW01-GC

Snap-in Frame • Solder Lug

Double Pole

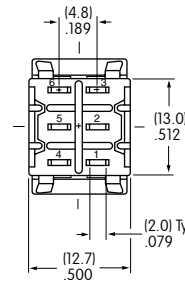
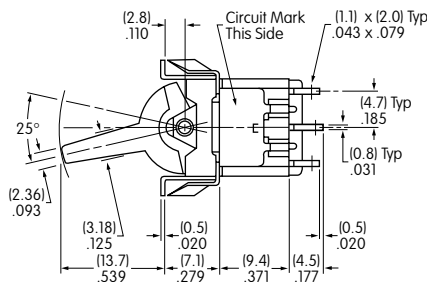
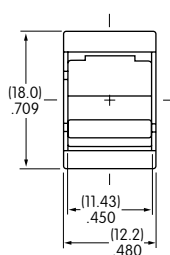

M2022TJW01-GC

TYPICAL SWITCH DIMENSIONS

Snap-in Frame • AT2107 Bezel • Solder Lug

Single & Double Pole

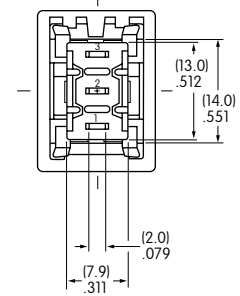
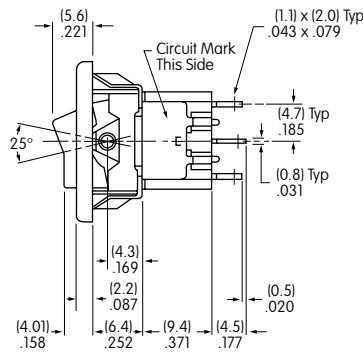
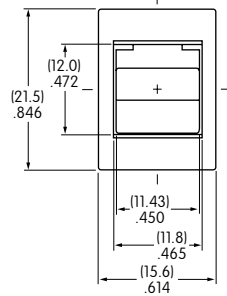

M2012JW01-FC-1A

Snap-in Frame • AT208 Bezel • Solder Lug

Double Pole

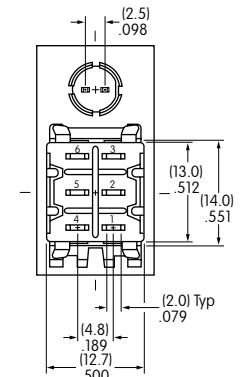
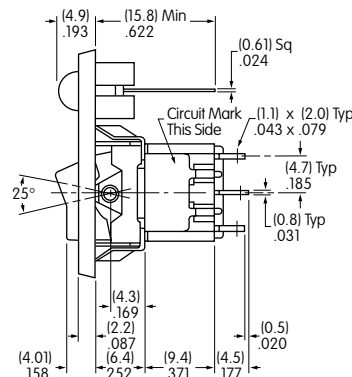
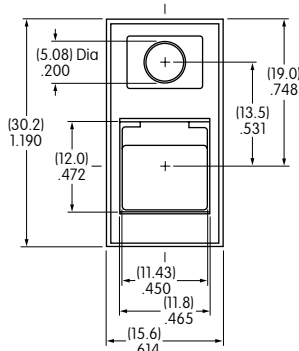

M2022JW01-FC-2A-C

Snap-in Frame • AT212 Bezel • Solder Lug

Single Pole

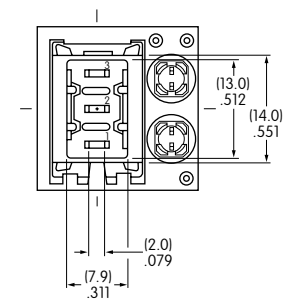
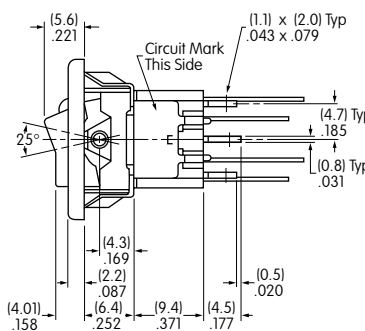
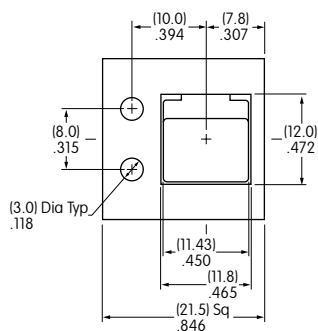

M2012JW01-FC-3A-CF

Snap-in Frame • AT213 Bezel • Solder Lug

Double Pole

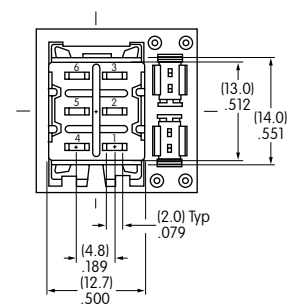
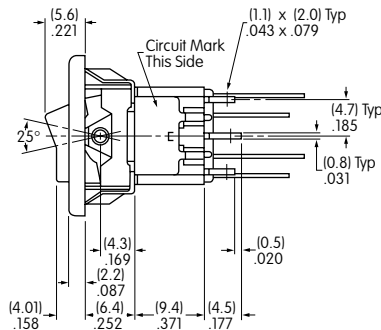
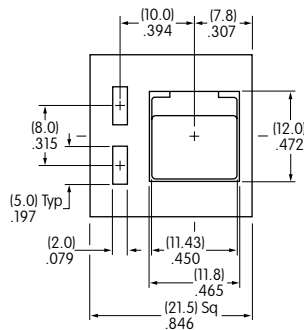

M2022JW01-FC-4A-CF

LEGENDS

General information and basic specifications are presented here for customers who want to do their own legends.

Suggested Printable Area for Cap

AT4150

Shaded areas are printable areas.



Recommended Print Method:

Screen Print or Pad Print

Epoxy based ink is recommended.

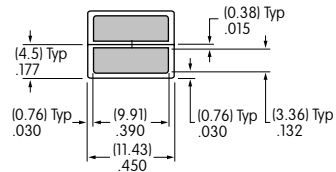

Additional Method

An additional method for legends is engraving the cap. Maximum depth for engraving is .012" (0.3mm) on the cap. Enamel paint is recommended to fill the engraved area.

LEGEND PACKET



1. To order caps with legends contact the factory and request the M Rocker Legend Packet.
2. Once you determine your desired legend, fill out the ordering work sheet included in the packet.
3. Return the completed work sheet to receive a quotation.