

AV series

Anti-vandal and security pushbutton switches

Distinctive features

- ❑ **Attractive, robust and durable**
 - Irremovable
 - **Anti-jamming construction : reduced travel to prevent insertion of foreign parts**
 - **Contact and mechanism protected against crushing**
 - Fire resistant
 - Long life
- ❑ **Sealed versions**
- ❑ **Degree of protection (switches mounted on vertical panels, as shown opposite) :**
 - standard version : IP54
 - sealed version : IP65

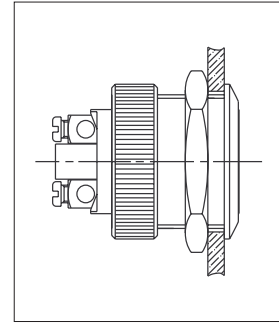

EXAMPLES OF MOUNTING FOR SEALED VERSIONS

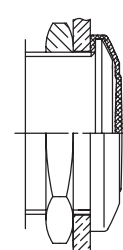
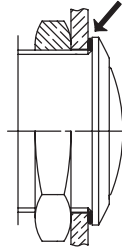
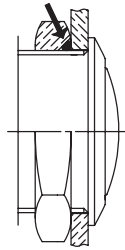

→ O-ring

Preferred

With boot U2187 (sect. H)



Packaging unit : specified on the following pages.



Mounting accessories : Standard and special hardware are presented in section I.

AV series

Anti-vandal and security pushbutton switches

Distinctive features

The AV series is a large range of security pushbutton switches including 4 product families :

ANTI-VANDAL PUSHBUTTON SWITCHES (page B-90)

- Increased impact resistance provided by a nut (\varnothing 19 mm) or mechanical stop (\varnothing 22 mm)
- Stainless steel actuator and bushing
- Bushing dia. 19 (.748) or 22 mm (.866)

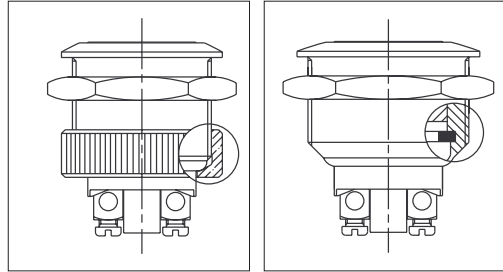

SECURITY PUSHBUTTON SWITCHES WITH LARGE ACTUATOR (page B-93)

- Ergonomic actuator dia. 20 (.787) or 30 mm (1.181)
- Tactile feedback
- Up to 5A 250VAC
- Bushing dia. 22 mm (.866) or 24 mm (.944)

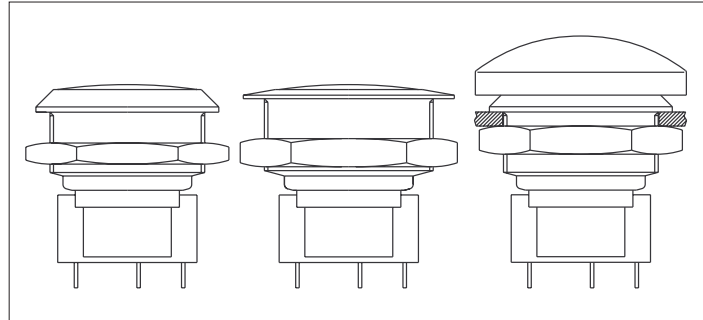

OTHER SECURITY PUSHBUTTON SWITCHES (page B-96)

- A large variety of actuator shapes, electrical functions, connections, finish and marking options
- Bushing dia. 16 (.629), 19 (.748) or 22 mm (.866)

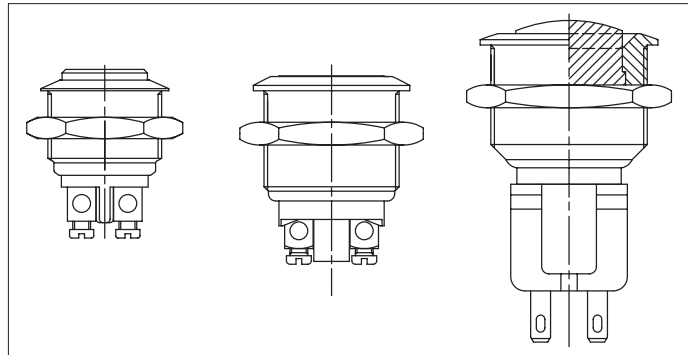

SNAP-ACTION SECURITY PUSHBUTTON SWITCHES (page B-104)

- Tactile feedback
- Illuminated or non-illuminated
- Bushing dia. 19 mm (.748)
- Models with overmolded actuator

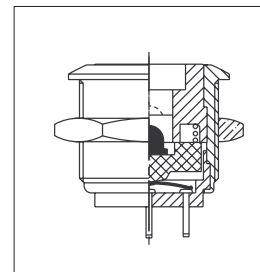

AV series

Anti-vandal pushbutton switches

Distinctive features and specifications

- Increased impact resistance provided by a nut or mechanical stop
- Stainless steel actuator and bushing
- UL-CSA approved (long case only)

B

SPECIFICATIONS

- Max. current/voltage rating with resistive load (C contacts) : 2A 48 VDC
- Approved ratings of models with long case and A contacts (AV..000) :
UL-CSA : 4A 250VAC - 8A 125VAC - 6.000 cycles
- Initial contact resistance : 10 mΩ max. at 1A 2V
- Insulation resistance : 1.000 MΩ min. at 500VDC
- Dielectric strength : 2.000 Vrms 50 Hz min. between terminals and frame
2.000 Vrms 50 Hz min. between terminals
- Electrical life : 10.000 cycles at full load
- Torque : 5 Nm min.- 14 Nm max. applied to nut
- Panel thickness : 1 (.039) to 11 mm (.433) max.
- Operating temperature : -30°C to +70°C
- Mechanical life : 1.000.000 cycles
- Packaging unit : 20 pieces (models Ø 22) or 40 pieces (models Ø 19)

MATERIALS

- Case : PBT
- Contacts : brass, silver plated (C) or silver (A)
- Bushing : stainless steel
- Actuator : stainless steel

CUT-OUTS

- Panel cut-out :
Ø 19,2 mm (.755)
or Ø 22,2 mm (.874)
- Min. pitch for matrix mounting :
30 mm (1.181) x 30 mm (1.181)

ROBUSTNESS

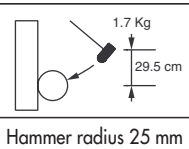
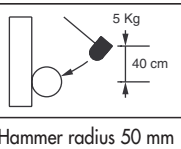
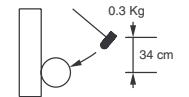
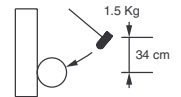
	Model Ø 19 mm (.748)		Model Ø 22 mm (.866)	
Degree of protection according to EN 50102, June 95 (NFC 20-015)		IK08 Striking energy: 5 joules (5Nm)		IK10 Striking energy: 20 joules (20Nm)
Impacts on actuator according to CECC 96000 Hammer radius 10 mm		10 strokes Striking energy: 1 joule (1Nm)		10 strokes Striking energy: 5 joules (5Nm)

SEALING (OPTION T)

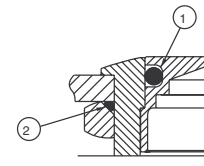

Front panel sealing (IP65)

- ① internal gasket ② external gasket

AV series

Anti-vandal pushbutton switches

Bushing $\varnothing 19 (.748)$ - momentary (NO)

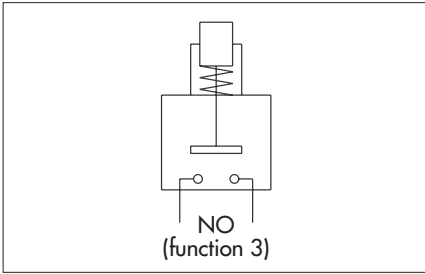

ORDER FORMAT

Series	Bush./act. config.	Case style	Function	Contact material	Terminal type	Bush./act. material	Sealing
AV	09 19 9D	100 000	3	C A	9 2	40	N T

To order a sealed product, replace N with T at the end of P/N.

B

BASIC MODEL

Short case - flat actuator - AV09100...40N

Hex nut 22 (.866) across flats



Screw terminals
AV091003C940N



Solder lug / quick-connect term.
AV091003C240N



Screw terminals for wires 1,5 mm² max.

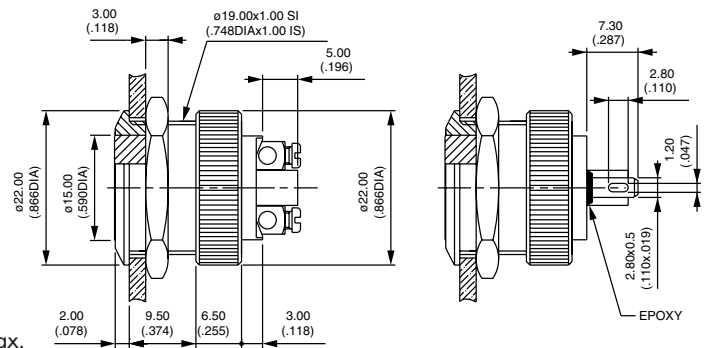

Long case - flat actuator - UL-CSA approved - AV09000...40N

Hex nut 22 (.866) across flats



New!

Screw terminals
AV090003A940N



Screw terminals for wires 1,5 mm² max.

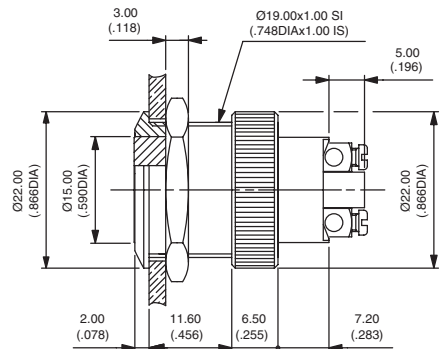

OTHER CONFIGURATIONS

Case style : replace • with 1 for short case and 0 for long case.

Curved actuator

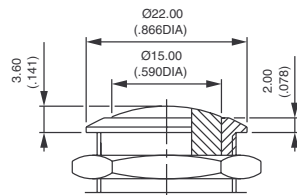

Screw terminals
AV19•003C940N
Solder lug / quick-connect terminals
AV19•003C240N

Flush model

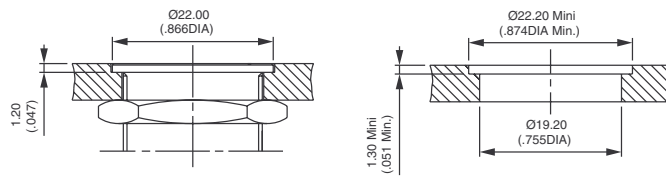

Screw terminals
AV9D•003C940N
Solder lug / quick-connect terminals
AV9D•003C240N

AV series

Anti-vandal pushbutton switches

Bushing $\varnothing 22 (.866)$ - momentary (NO)

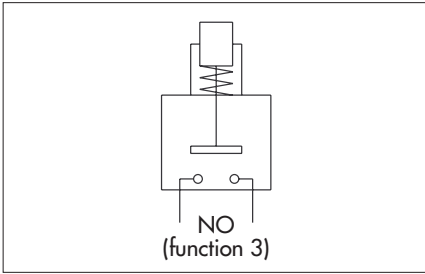
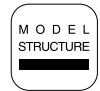

ORDER FORMAT

Series	Bush./act. config.	Case style	Function	Contact material	Terminal type	Bush./act. material	Sealing
AV	03 02 M3 M2	100 000	3	C A	9 2	40	N T

To order a sealed product, replace N with T at the end of P/N.

B

BASIC MODEL

Short case - flat actuator - AV03100...40N



Screw terminals
AV031003C940N



Solder lug / quick-connect term.
AV031003C240N



Screw terminals for wires 1,5 mm² max.

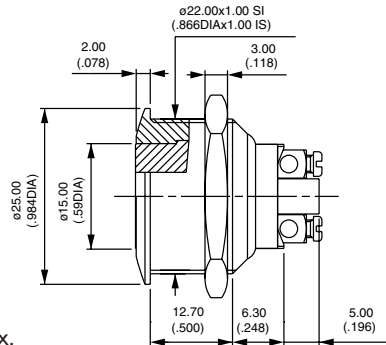

Hex nut 25 (.984) across flats

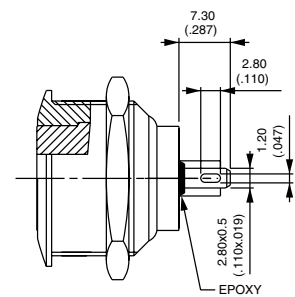

Long case - flat actuator - UL-CSA approved - AV03000...40N



New!

Screw terminals
AV030003A940N



Screw terminals for wires 1,5 mm² max.

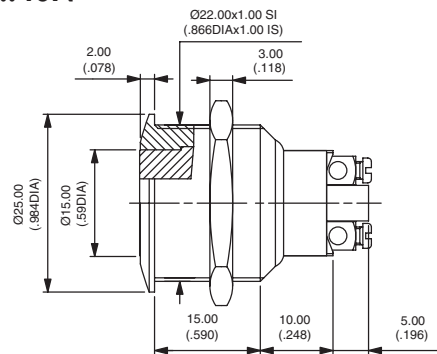

Hex nut 25 (.984) across flats

OTHER CONFIGURATIONS

Case style : replace • with 1 for short case and 0 for long case.

Curved actuator

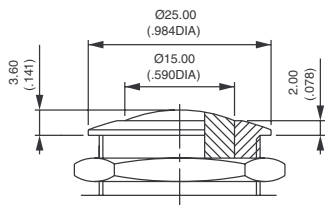

Screw terminals
AV02•003C940N
Solder lug / quick-connect term.
AV02•003C240N

Flatted bushing

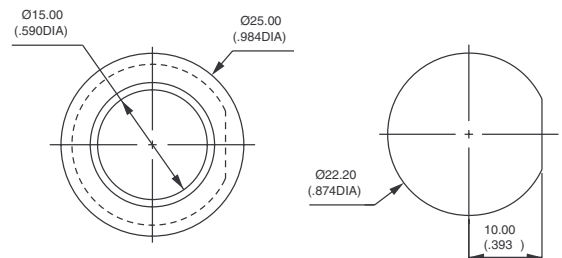

Flat actuator
Screw terminals
AVM3•003C940N

Curved actuator
Screw terminals
AVM2•003C940N



AV series

Security pushbutton switches with large actuator

Bushing Ø 22 (.866) - momentary (combined NC/NO)

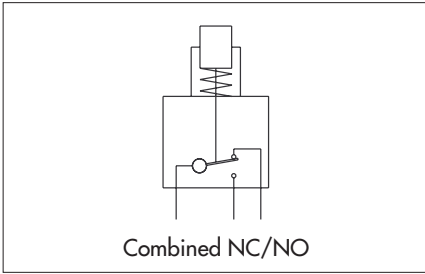

ORDER FORMAT

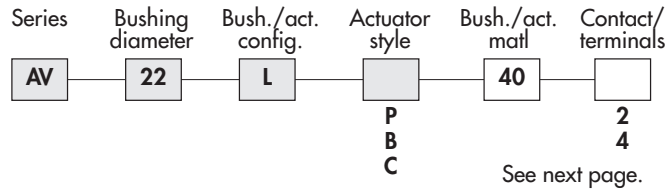

SPECIFICATIONS

- Max. current/voltage rating with resistive load : 5A 250VAC
- Initial contact resistance : 100 mΩ max.
- Insulation resistance : 1.000 MΩ min. at 500VDC
- Dielectric strength : 2.000 Vrms 50 Hz min. between terminals and frame
- Electrical life : 1.000.000 cycles at 1A 250VAC
50.000 cycles at full load
- Torque : 5 Nm min.- 14 Nm max. applied to nut
- Panel thickness : 1 (.039) to 6 mm (.236) max.
- Operating temperature : -20°C to +55°C
- Mechanical life : 3.000.000 cycles
- Front panel sealing : IP65
- Packaging unit : 20 pieces (except black chrome plated : 16 pieces)

MATERIALS

- Case : polyester, glass filled
- Contacts : silver/nickel alloy
- Bushing : stainless steel (std)
- Actuator : stainless steel (std)

CUT-OUT

- Panel cut-out : Ø 22,2 (.874) or Ø 24,2 (.952)
- Min. pitch for matrix mounting : 30 mm x 30 mm (1.181x1.181)

All model numbers below are for switches with standard bushing/actuator material.

BASIC MODEL

Flat actuator - solder lug terminals - AV22LP

→ O-ring

Hex nut 25 (.984) across flats



AV22LP402

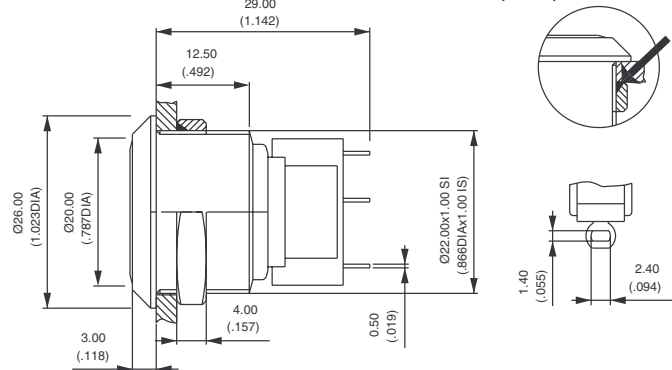

OTHER CONFIGURATIONS

Curved actuator

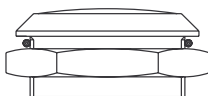

AV22LB402

Recessed actuator

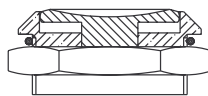

AV22LC402

B

AV series

Security pushbutton switches with large actuator

Bushing \varnothing 24 (.944) - low profile - momentary (combined NC/NO)



BASIC MODEL

Flat actuator - solder lug terminals - AV24LP



AV24LP402



→ O-ring

Hex nut 27 (1.062) across flats

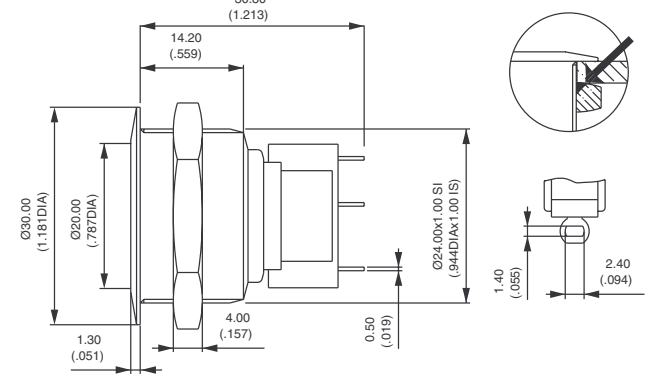

B

OTHER CONFIGURATIONS

Curved actuator

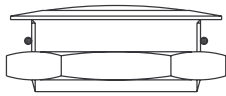

AV24LB402

Recessed actuator

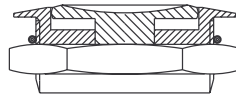

AV24LC402

BUSHING / ACTUATOR MATERIAL

For non-standard material, replace **40** with one of the following codes.

Models with non-anodized actuator

CODE	BUSHING	ACTUATOR
40 (standard)	Stainless steel	Stainless steel
20	Chrome plated brass	Chrome plated brass

Models with anodized actuator

CODE	BUSHING	ACTUATOR COLOUR
1•	Black chrome plated brass	Replace • with one of the following codes :
2•	Chrome plated brass	1 : blue - 2 : black - 3 : pale green - 3F : dark green - 4 : natural - 5 : gold yellow
4•	Stainless steel	6 : red - 6B : maroon

CONTACT / TERMINALS

2 (standard)	NC/NO, solder lug terminals
4	NC/NO, quick-connect terminals

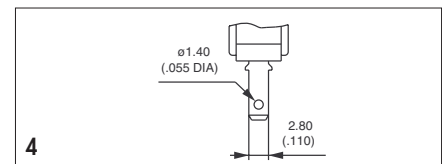

AV series

Security pushbutton switches

Bushing \varnothing 16 (.629) - momentary (NO)

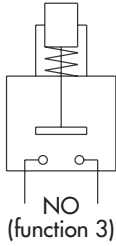
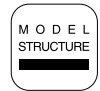

ORDER FORMAT

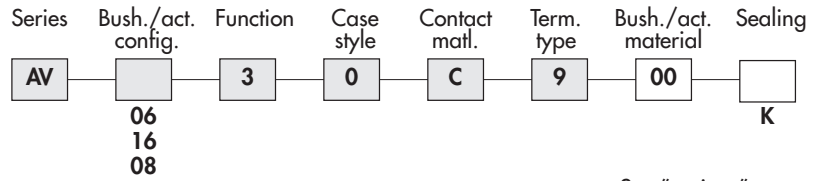

See "options" page.

SPECIFICATIONS

- Max. current/voltage rating with resistive load : 200mA 48 VDC - 100mA 48VDC
- Initial contact resistance : 50 m Ω max.
- Insulation resistance : 1.000 M Ω min. at 500VDC
- Dielectric strength : 2.000 Vrms 50 Hz min. between terminals and frame
- Electrical life : 50.000 cycles at 200mA 48VDC
100.000 cycles at 100mA 48VDC
- Torque : 5 Nm min.- 14 Nm max. applied to nut
- Panel thickness : 1 (.039) to 6 mm (.236) max.
- Operating temperature : -30°C to +70°C
- Mechanical life : 1.000.000 cycles
- Packaging unit : 60 pieces

MATERIALS

- Case : PBT
- Contacts : brass, silver plated (C)
- Bushing and actuator : nickel plated brass (std)

CUT-OUT

- Panel cut-out : \varnothing 16,2 (.637)
- Min. pitch for matrix mounting : 24 mm x 24 mm (.944 x .944)

All model numbers below are for switches with standard bushing/actuator material, without marking.

BASIC MODEL

Flat actuator - screw terminals - AV06

Hex nut 19 (.748) across flats



AV0630C900

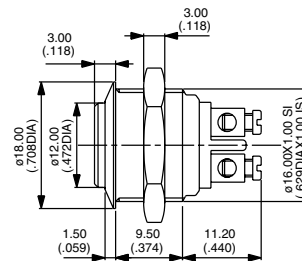

Screw terminals for wires 1,5 mm² max.

OTHER CONFIGURATIONS

Curved actuator

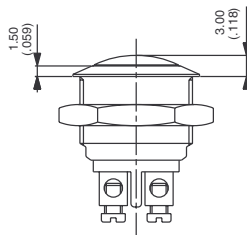

AV1630C900

Curved actuator w. chamfer

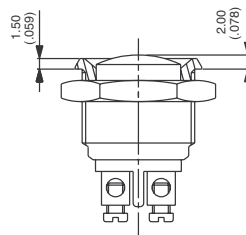

AV0830C900



AV series

New!

Security pushbutton switches

Bushing Ø 16 (.629) - latching action

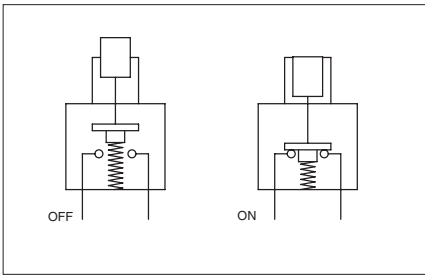

ORDER FORMAT

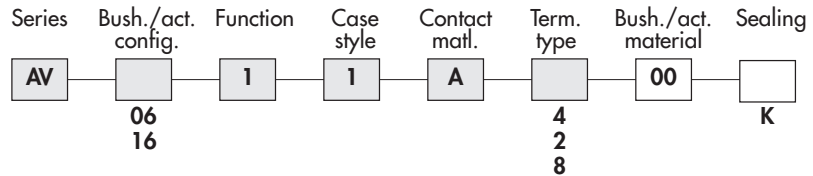

See "options" page.

SPECIFICATIONS

- Max. current/voltage rating with resistive load : 1,5A 250VAC - 1A 24VDC
- Initial contact resistance : 50mΩ max.
- Insulation resistance : 1 GΩ min. at 500VDC
- Dielectric strength : 1.500 Vrms 50 Hz min. between terminals
1 000 Vrms 50 Hz between terminals and frame
- Electrical life : 100.000 cycles at 1,5A 250VAC
40.000 cycles at 1A 24VDC
- Torque : 5 Nm min. - 14 Nm max. applied to nut
- Panel thickness : 1 (.039) to 6 mm (.236) max.
- Operating temperature : -30°C to +70°C
- Mechanical life : 200.000 cycles
- Packaging unit : 25 pieces

MATERIALS

- Case : PA-6T, UL94-V0
- Contacts : silver (A)
Gold plated silver (AD) on request.
- Bushing and actuator : nickel plated brass (std)

CUT-OUT

- Panel cut-out : Ø 16,2 (.637)
- Min. pitch for matrix mounting :
24 mm x 24 mm (.944 x .944)

B

All model numbers below are for switches with standard bushing/actuator material, without marking.

BASIC MODEL

Solder lug terminals - AV..11A200



Flat actuator
AV0611A200 OFF - ON

Curved actuator
AV1611A200 OFF - ON

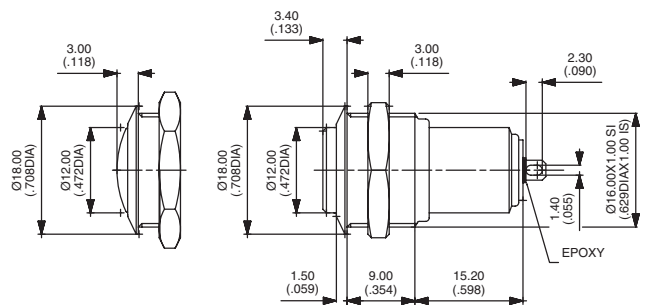

Hex nut 19 (.748) across flats

OTHER CONFIGURATIONS

Straight PC terminals

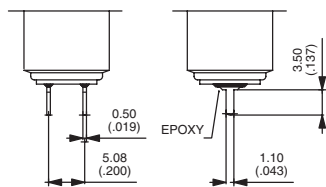

Flat actuator
AV0611A400

Curved actuator
AV1611A400

Quick-connect terminals

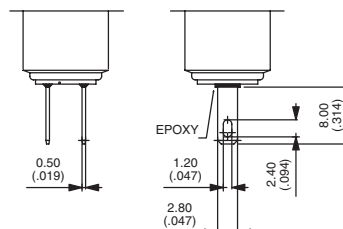

Flat actuator
AV0611A800

Curved actuator
AV1611A800

AV series

Security pushbutton switches

Bushing \varnothing 19 (.748) - momentary (combined NC/NO)

New!

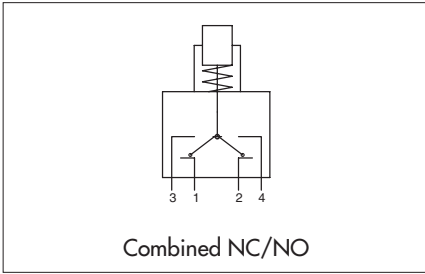
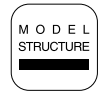

ORDER FORMAT

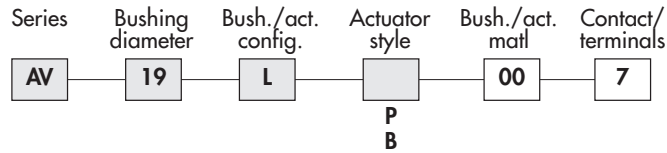

See below

SPECIFICATIONS

- Max. current/voltage rating with resistive load :
5A 250VAC - 5A 125VAC - 6.000 cycles
5A 15VDC - 3A 30VDC - 50.000 cycles
- Initial contact resistance : 100 m Ω max.
- Insulation resistance : 1.000 M Ω min. at 500VDC
- Dielectric strength : 2.000 Vrms 50 Hz min. between term. and frame
- Torque : 5 Nm min.- 14 Nm max. applied to nut
- Panel thickness : 1 (.039) to 9 mm (.354) max.
- Operating temperature : -20°C to +85°C
- Mechanical life : 1.000.000 cycles
- Front panel sealing : IP65
- Packaging unit : 20 pieces

MATERIALS

- Case : PA 6/6
- Contacts : silver
- Bushing : nickel pl. brass (std)
- Actuator : nickel pl. brass (std)

CUT-OUT

- Panel cut-out : \varnothing 19,2 mm (.755)
- Min. pitch for matrix mounting :
30 mm x 30 mm (1.181x1.181)

All model numbers below are for switches with standard bushing/actuator material.

BASIC MODEL

Solder lug terminals - AV19..007



Flat actuator
AV19LP007

Curved actuator
AV19LB007



→ O-ring

Hex nut 22 (.866) across flats

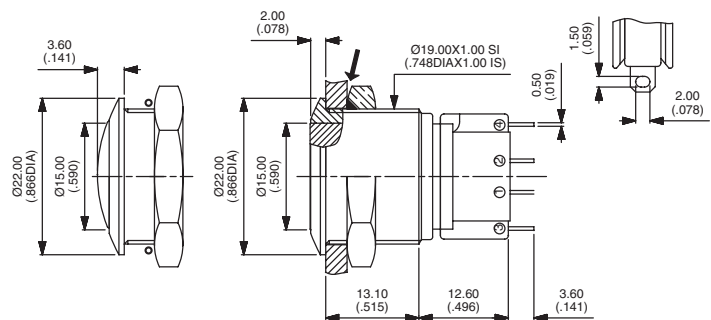

BUSHING/ACTUATOR MATERIAL

For non-standard material, replace **00** with one of the following codes.

CODE	BUSHING	ACTUATOR
00 (std)	Nickel plated brass	Nickel plated brass
20	Chrome plated brass	Chrome plated brass
40	Stainless steel	Stainless steel



AV series

Security pushbutton switches

Bushing \varnothing 19 (.748) - momentary (NO)

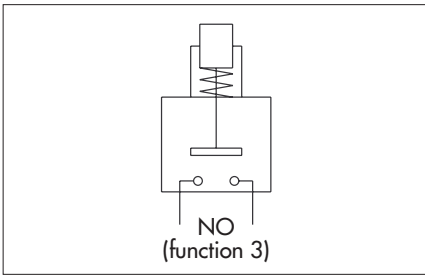

ORDER FORMAT

Series	Bush./act. config.	Case style	Function	Contact matl.	Term. type	Bush./act. material	Marking	Sealing
AV	09 19 9P 9B	100 000	3	C A	9 2	00		K

See "options" page.

SPECIFICATIONS

- Max. current/voltage rating with resistive load (C contacts): 2A 48 VDC
- Approved ratings of models with long case and A contacts (AV..000) :
UL-CSA : 4A 250VAC - 8A 125VAC - 6.000 cycles
- Initial contact resistance : 10 m Ω max. at 1A 2V
- Insulation resistance : 1.000 M Ω min. at 500VDC
- Dielectric strength : 2.000 Vrms 50 Hz min. between terminals and frame
2.000 Vrms 50 Hz min. between terminals
- Electrical life : 10.000 cycles at full load
- Torque : 5 Nm min.- 14 Nm max. applied to nut
- Panel thickness : 1 (.039) to 11 mm (.433) max.
- Operating temperature : -30°C to +70°C
- Mechanical life : 1.000.000 cycles
- Packaging unit : 40 pieces

MATERIALS

- Case : PBT
- Contacts : brass, silver plated (C) or silver (A)
- Bushing : brass, nickel plated (std)
- Actuator : brass, nickel plated (std)

CUT-OUT

- Panel cut-out :
 \varnothing 19,2 mm (.755)
- Min. pitch for matrix mounting :
30 mm (1.181) x 30 mm (1.181)

B

All model numbers below are for switches with standard bushing/actuator material, without marking.

BASIC MODEL

Short case - flat actuator - AV09100...00

Hex nut 22 (.866) across flats



Screw terminals
AV091003C900

Solder lug /
quick-connect term.
AV091003C200

Screw terminals for wires 1,5 mm² max.

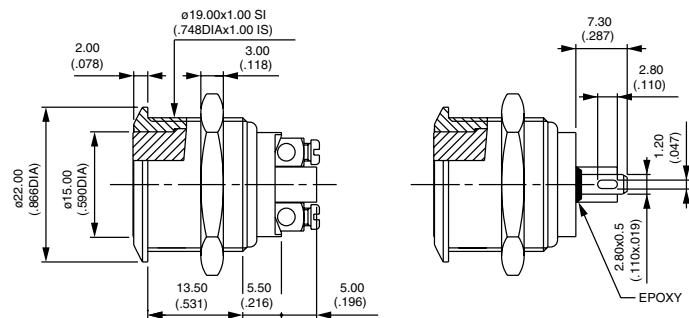

Long case - flat actuator - UL-CSA approved - AV09000...00

Hex nut 22 (.866) across flats



New!

Screw terminals
AV090003A900

Screw terminals for wires 1,5 mm² max.

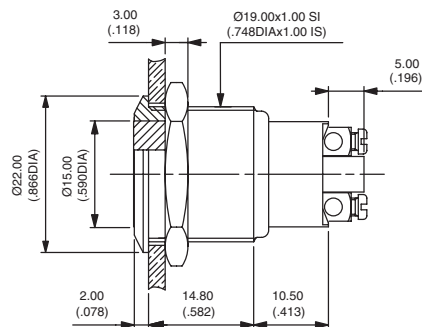

AV series

Security pushbutton switches

Bushing \varnothing 19 (.748) - momentary (NO)

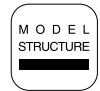

OTHER CONFIGURATIONS

Case style : replace • with 1 for short case and 0 for long case.

Curved actuator

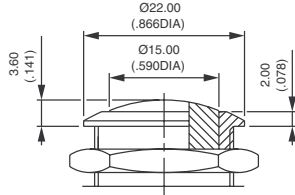

Screw terminals
AV19•003C900
 Solder lug / quick-connect terminals
AV19•003C200

With knurled nut for matrix mounting 25 (.984) x 25 (.984)

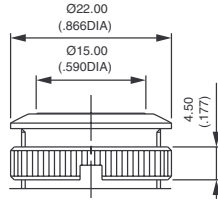

Flat actuator, screw term.
AV9P•003C900
 Flat actuator, solder lug term.
AV9P•003C200

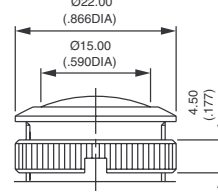

Curved actuator, screw term.
AV9B•003C900
 Curved act., solder lug term.
AV9B•003C200

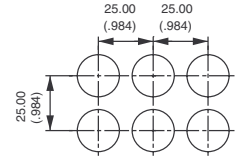

Wrench available under P/N U1929.

B

AV series

Security pushbutton switches

Bushing \varnothing 19 (.748) - other electrical functions

Bushing \varnothing 19 (748) - combined NC/NO - AV..9035

Hex nut 22 (.866) across flats

- Single pole, solder lug terminals
- Gold plated silver contacts
- Current/voltage rating with resistive load :
 max. : 1A 30V - min : 10 μ A 5V
 Note : a current above 100mA damages the gold plating.
- Dielectric strength : 1.000 Vrms between terminals
 2.000 Vrms between terminals and frame
- Electrical life : 250.000 cycles at full load
- Mechanical life : 1.000.000 cycles
- Packaging unit : 20 pieces
- Further specifications : see previous page.

Flat actuator
AV099035D200

Curved actuator
AV199035D200

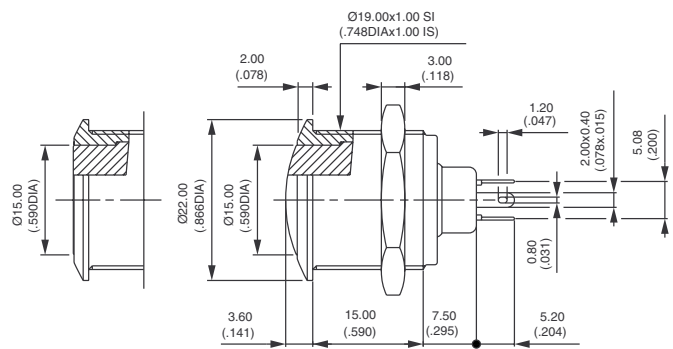

Bushing/actuator materials, marking and sealing : see "options" page.



AV series

Security pushbutton switches

Bushing \varnothing 22 (.866) - momentary (NO)

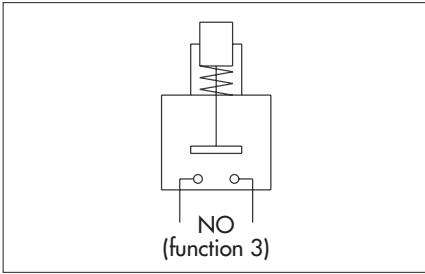

ORDER FORMAT

Series	Bush./act. config.	Case style	Function	Contact matl.	Term. type	Bush./act. material	Marking	Sealing
AV	03 02 M3 M2	100 000	3	C A	9 2	00		K

See "options" page.

SPECIFICATIONS

- Max. current/voltage rating with resistive load (C contacts): 2A 48 VDC
- Approved ratings of models with long case and A contacts (AV..000) :
UL-CSA : 4A 250VAC - 8A 125VAC - 6.000 cycles
- Initial contact resistance : 10 m Ω max. at 1A 2V
- Insulation resistance : 1.000 M Ω min. at 500VDC
- Dielectric strength : 2.000 Vrms 50 Hz min. between terminals and frame
2.000 Vrms 50 Hz min. between terminals
- Electrical life : 10.000 cycles at full load
- Torque : 5 Nm min.- 14 Nm max. applied to nut
- Panel thickness : 1 (.039) to 11 mm (.433) max.
- Operating temperature : -30°C to +70°C
- Mechanical life : 1.000.000 cycles
- Packaging unit : 20 pieces

MATERIALS

- Case : PBT
- Contacts : brass, silver plated (C) or silver (A)
- Bushing : brass, nickel plated (std)
- Actuator : brass, nickel plated (std)

CUT-OUTS

- Panel cut-out :
 \varnothing 22,2 mm (.874)
- Min. pitch for matrix mounting :
30 mm (1.181) x 30 mm (1.181)

B

All model numbers below are for switches with standard bushing/actuator material, without marking.

BASIC MODEL

Short case - flat actuator - AV03100...00

Hex nut 25 (.984) across flats



Screw terminals
AV031003C900

Solder lug /
quick-connect term.
AV031003C200

Screw terminals for wires 1,5 mm² max.

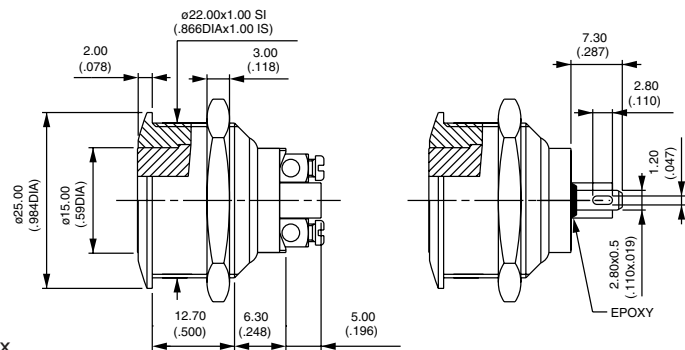

Long case - flat actuator - UL-CSA approved - AV03000...00

Hex nut 25 (.984) across flats



New!

Screw terminals
AV030003A900

Screw terminals for wires 1,5 mm² max.

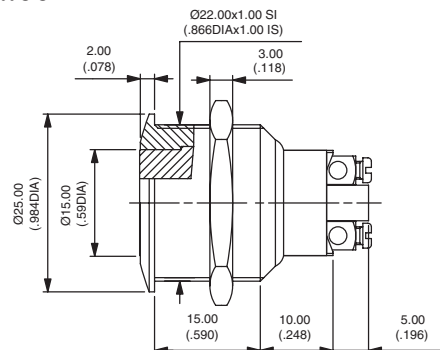

AV series

Security pushbutton switches

Bushing Ø 22 (.866) - momentary (NO)

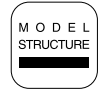

OTHER CONFIGURATIONS

Case style : replace • with 1 for short case and 0 for long case.

Curved actuator

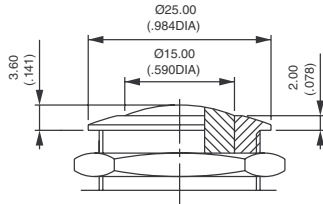

Screw terminals
AV02•003C900
Solder lug / quick-connect terminals
AV02•003C200

Flatted bushing

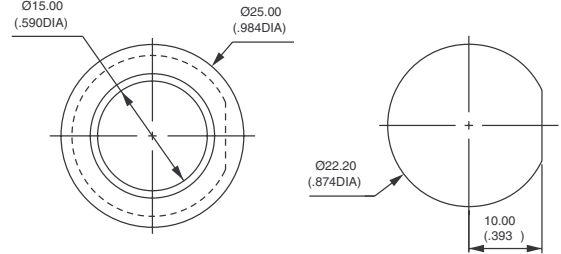

Flat actuator
Screw terminals
AVM3•003C900

Curved actuator
Screw terminals
AVM2•003C900

AV series

Security pushbutton switches

Bushing Ø 22 (.866) - other electrical functions

Bushing Ø 22 (.866) - Normally closed (NC) - AV..1200

Hex nut 25 (.984) across flats

- Single pole, screw terminals, without marking
- Silver plated copper contacts (C)
- Max. current/voltage rating with resistive load :
2A 250VAC - 3A 125VAC - 2,5A 24VDC
- Dielectric strength :
2.000 Vrms 50 Hz min. betw. term. and frame
2.000 Vrms. 50 Hz min. between terminals
- Electrical life : 100.000 cycles at 0,3A 24VAC or DC
10.000 cycles at full load
- Packaging unit : 20 pieces

Flat actuator
AV031202C00

Curved actuator
AV021202C00

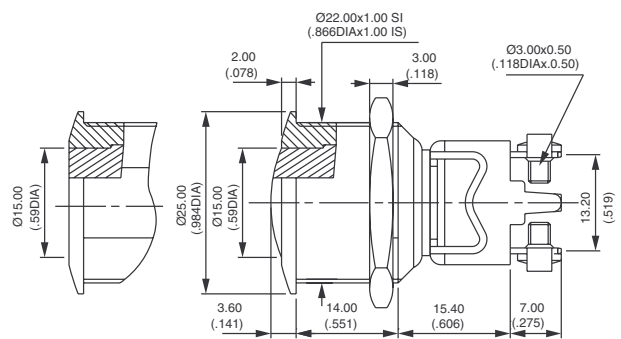

Bushing Ø 22 (.866) - alternate action - AV..4700

Hex nut 25 (.984) across flats

- Double pole, solder lug/quick-connect term., curved actuator
- Silver contacts
- Max. current/voltage rating with resistive load :
3(1,5)A 250VAC - 6A 125VAC - 3A 24VAC or DC
- Dielectric strength :
3.000 Vrms min. between terminals and frame
- Electrical life : 10.000 cycles at full load
50.000 cycles at 1A 24VAC or DC
- Mechanical life : 100.000 cycles
- Packaging unit : 10 pieces

AV044746A200

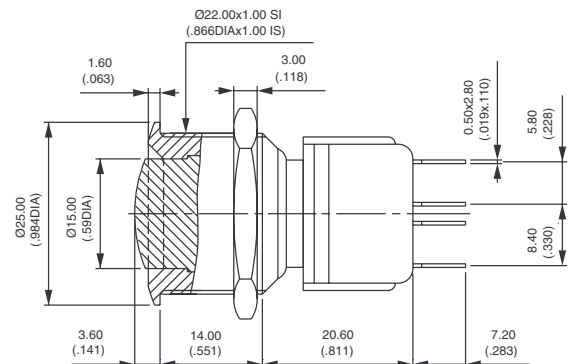

Further specifications : see previous page. Bushing/actuator materials, marking and sealing : see "options" on next page.



AV series

Security pushbutton switches

Options

After selecting basic model number, fill in last 3 boxes with desired options.

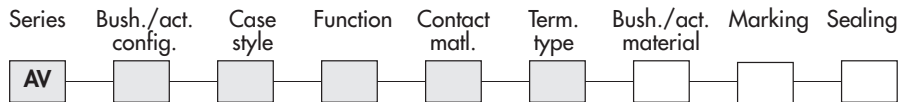

BUSHING/ACTUATOR MATERIAL

For non-standard material, replace **00** with one of the following codes.

Flat or curved metal actuator

** Option 80 not available on models with dia. 16 mm (.629) bushing

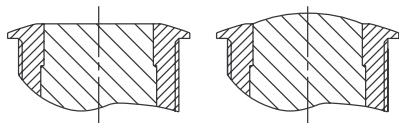

CODE	BUSHING	ACTUATOR
00 (standard)	Nickel plated brass	Nickel plated brass
10	Nickel plated brass	Stainless steel
12	Nickel plated brass	Chrome plated brass
20	Chrome plated brass	Chrome plated brass
30	Chrome plated brass	Stainless steel
40	Stainless steel	Stainless steel
80 **	Varnished polished brass	Varnished polished brass

Flat thermoplastic actuator (not available with dia. 16 mm (.629) bushing)

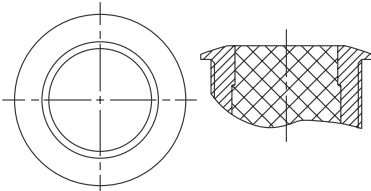

CODE	BUSHING	ACTUATOR COLOUR
0• (standard)	Nickel plated brass	Replace • with one of the following codes.
2•	Chrome plated brass	1 : blue - 2 : black - 3 : green - 4 : grey
8•	Varnished polished brass	5 : yellow - 6 : red - 7/1 : white - 9 : orange

MARKING

Select an option from each of the two tables below.

For flat or curved actuator.

Not available on model AV031202C00.

- by engraving on brass actuator (stainless steel on request)
- by hot stamping on thermoplastic actuator.

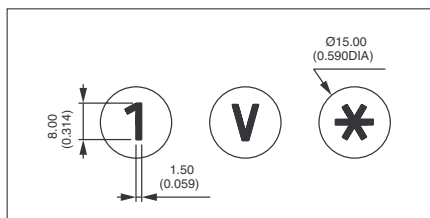

TYPE OF MARKING	
CODE	TYPE
0 to 9	Numbers 0 to 9
X	Symbol *
Y	Symbol #
A to N	Letters A to N
P to W	Letters P to W
O	Letter O

Letter O : same code and same design as number 0.
For special symbols, consult factory.
Minimum order : 500 pieces

COLOUR OF MARKING	
CODE	COLOUR
Brass actuator	
0 (standard)	Same as finish
2	Black
Note : a finished product supplied in version "0" cannot be modified to version "2".	
Thermoplastic actuator	
2	Black
7	White

SEALING

Blank No sealing

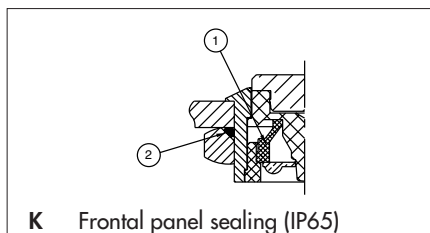

K Frontal panel sealing (IP65)

For types with bushing Ø 16

- ① elastomeric membrane
- ② external gasket

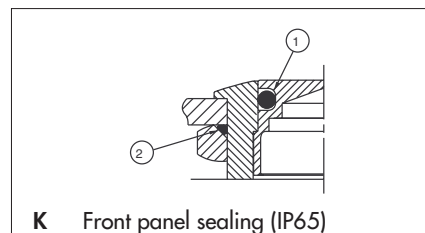

K Frontal panel sealing (IP65)

For types with bushing Ø 19 or Ø 22

- ① internal gasket
- ② external gasket

AV series

Snap-action security pushbutton switches

Bushing \varnothing 19 (.748) - illuminated or not - momentary (NO)

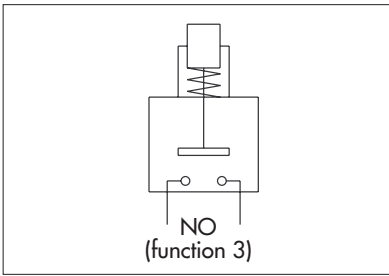
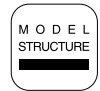

ORDER FORMAT

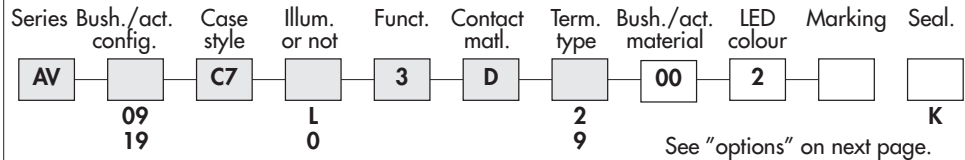

SPECIFICATIONS

- Max. current/voltage rating with resistive load : 50mA 24VDC
- LED voltage and consumption : 2-colour LED : 2V (3V max.) 20mA
Other colours : 2V (3V max.) 10mA
A resistor must be series-connected by the user.**
- Initial contact resistance : 100 m Ω max.
- Insulation resistance : 1.000 M Ω min. at 500VDC
- Dielectric strength : 500 Vrms 50 Hz min. between terminals
2.000 Vrms 50 Hz min. between terminals and bushing
- Electrical life : 1.000.000 cycles at full load
- Operating force : 7 N \pm 2N
- Travel : 0,7 mm (.027) \pm 0,1 mm (.003)
- Torque : 5 Nm min.- 14 Nm max. applied to nut
- Panel thickness : 1 (.039) to 11 mm (.433) max.
- Operating temperature : -30°C to +70°C
- Soldering : 270°C max. during 3 sec.
- Packaging unit : 40 pieces

** Resistor value = $\frac{\text{supply voltage} - \text{LED forward voltage}}{\text{LED forward current}}$

MATERIALS

- Case : PBT UL94-V0
- Terminals : brass, gold plated
- Contacts : gold plated dome
- Bushing : brass, nickel plated (std)
- Actuator : brass, nickel plated (std)
- LED

CUT-OUTS

- Panel cut-out :
 \varnothing 19,2 mm (.755)
- Min. pitch for matrix mounting :
30 mm (1.181) x 30 mm (1.181)

All model numbers below are for switches with standard bushing/actuator material, without marking.

Flat actuator - non-illuminated



Solder lug terminals
AV09C703D200

Screw terminals
AV09C703D900



Also available with curved actuator :
AV19C703D200 or AV19C703D900

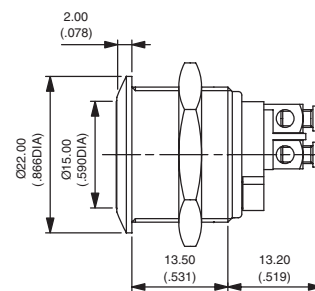

Hex nut 22 (.866) across flats

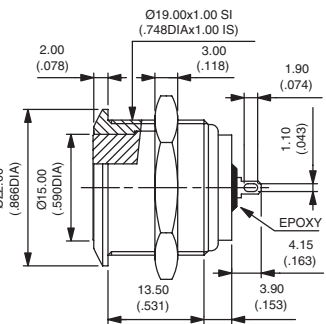

Flat actuator - illuminated



Solder lug terminals
AV09C7L3D200

Screw terminals
AV09C7L3D900

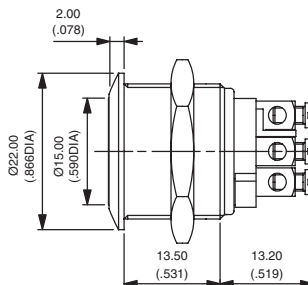

Hex nut 22 (.866) across flats

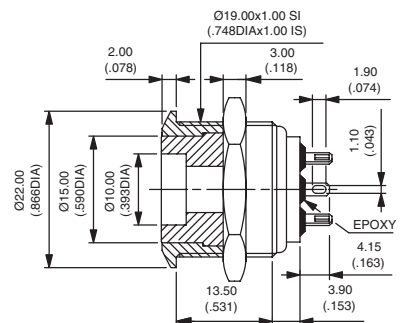



AV series

Snap-action security pushbutton switches

Options

After selecting basic model no., fill in last 4 boxes with desired options.

Series	Bush./act. config.	Case style	Illum. or not	Funct.	Contact matl.	Term. type	Bush./act. material	LED colour	Marking	Seal.
AV										

BUSHING/ACTUATOR MATERIAL

For non-standard material, replace **00** with one of the following codes.

Non-illuminated models			Illuminated models		
CODE	BUSHING	ACTUATOR	CODE	BUSHING	ACTUATOR
00 (std)	Nickel plated brass	Nickel plated brass	00 (std)	Nickel plated brass	Nickel plated brass
10	Nickel plated brass	Stainless steel	20	Chrome plated brass	Chrome plated brass
30	Chrome plated brass	Stainless steel	40	Stainless steel	Stainless steel
40	Stainless steel	Stainless steel	45	Stainless steel	Nickel plated brass
80	Varnished polished brass	Varnished polished brass	80	Varnished polished brass	Varnished polished brass

B

LED COLOUR

Blank No LED

1 : Blue - 3 : Green - 5 : Yellow - 6 : Red - 7 : White - 9 : Amber - 2 : Red/green

MARKING

Select an option from each of the two tables below.

For flat or curved actuator.

- by engraving on non-illuminated brass actuator (stainless steel on request).
- by hot stamping on thermoplastic insert (illuminated actuators)

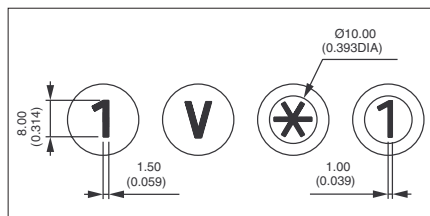

TYPE OF MARKING	
CODE	TYPE
0 to 9	Numbers 0 to 9
X	Symbol *
Y	Symbol #
A to N	Letters A to N
P to W	Letters P to W
0	Letter O

Letter O : same code and same design as number 0.
For special symbols, consult factory.
Minimum order : 500 pieces

COLOUR OF MARKING	
CODE	COLOUR
Non-illuminated actuators	
0 (standard)	Same as finish
2	Black
Note : a finished product supplied in version "0" cannot be modified to version "2".	
Illuminated actuators	
2	Black (on white)

SEALING

Blank No sealing

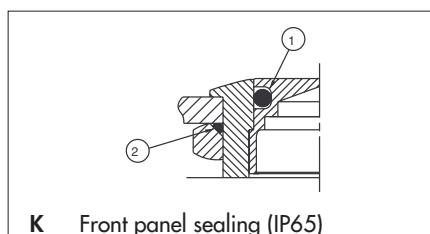

- ① internal gasket
- ② external gasket

AV series

Snap-action security pushbuttons with overmolded actuator

New!

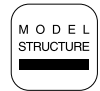

Bushing Ø 19 (.748) - illuminated or not - momentary (NO)

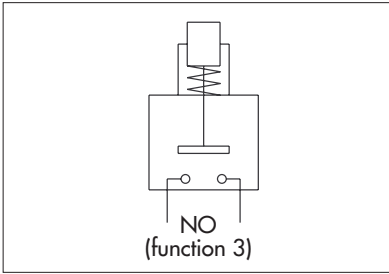

ORDER FORMAT

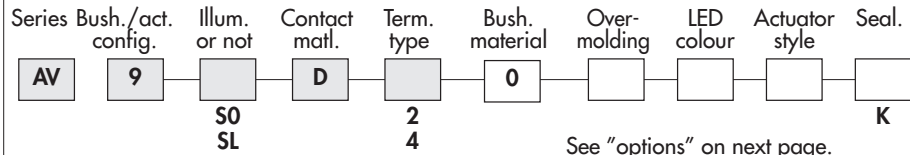

See "options" on next page.

SPECIFICATIONS

- Max. current/voltage rating with resistive load : 50mA 24VDC
- LED voltage and consumption : 2-colour LED : 2V (3V max.) 20mA
Other colours : 2V (3V max.) 10mA
A resistor must be series-connected by the user.**
- Initial contact resistance : 100 mΩ max.
- Insulation resistance : 1.000 MΩ min. at 500VDC
- Dielectric strength : 500 Vrms 50 Hz min. between terminals
2.000 Vrms 50 Hz min. between terminals and bushing
- Electrical life : 1.000.000 cycles at full load
- Operating force : 7 N +/- 2N
- Travel : 0,7 mm (.027) +/- 0,1 mm (.003)
- Torque : 5 Nm min. - 14 Nm max. applied to nut
- Panel thickness : 1 (.039) to 11 mm (.433) max.
- Operating temperature : -30°C to +70°C
- Soldering : 270°C max. during 3 sec.
- Packaging unit : 40 pieces

** Resistor value = $\frac{\text{supply voltage} - \text{LED forward voltage}}{\text{LED forward current}}$

MATERIALS

- Case : PBT UL94-V0
- Terminals : brass, gold plated
- Contacts : gold plated dome
- Bushing : brass, nickel plated (std)
- Actuator : stainless steel, with thermoplastic overmolding
- LED

CUT-OUTS

- Panel cut-out : Ø 19,2 mm (.755)
- Min. pitch for matrix mounting : 30 mm (1.181) x 30 mm (1.181)

Solder lug terminals



Illuminated
AV9SLD2

Non illuminated
AV9SOD2

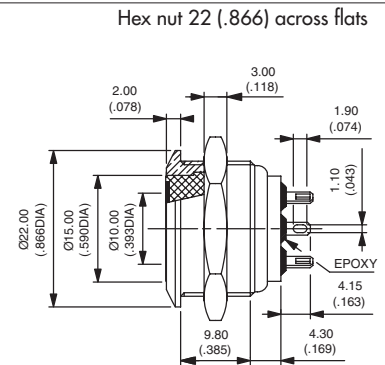
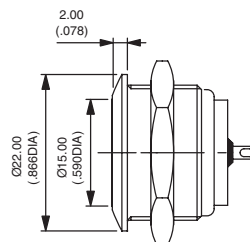

Also available with bushing Ø 22 (.866) : on request.

Straight PC terminals



Illuminated
AV9SLD4

Non illuminated
AV9SOD4

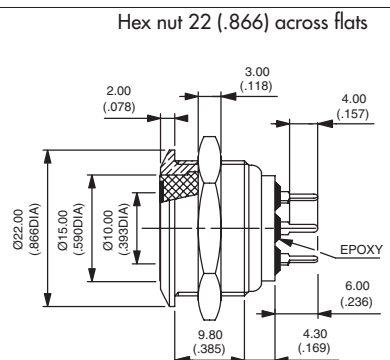
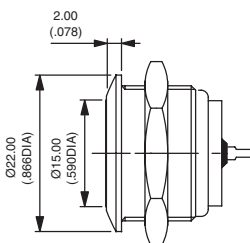

Also available with bushing Ø 22 (.866) : on request.



AV series

New! Snap-action security pushbuttons with overmolded actuator

Options

After selecting basic model no., fill in last 5 boxes with desired options.

Series	Bush./act. config.	Illum. or not	Contact matl.	Term. type	Bush. material	Over-molding	LED colour	Actuator style	Seal.
AV									

BUSHING MATERIALS

CODE	MATERIAL
0 (std)	Nickel plated brass
2	Chrome plated brass
4	Stainless steel
5	Gold plated brass
6	Chrome plated brass, satin
7	Chrome pl. brass, matt black
8	Varnished polished brass
9	Polished brass

COLOUR OF OVERMOLDING

CODE	COLOUR
1	Blue
2	Black
3	Green
4	Grey
5	Yellow
6	Red
7	White
8	Translucent
9	Orange

LED COLOURS

CODE	COLOUR
Blank	No LED
1	Blue
2	Red/green
3	Green
5	Yellow
6	Red
7	White
9	Amber

B

ACTUATOR STYLES

The ring and symbols are obtained by photochemical engraving of a stainless steel insert. The insert is then overmolded in the desired colour.

The following actuator styles are available. For other types, consult factory.

CODE	001	002	003	004	005
DESCRIPTION	Illuminated ring and disc	Illuminated ring	Arrow	Loudspeaker OFF	Double arrow
RING/SYMBOL					

SEALING

Blank No sealing

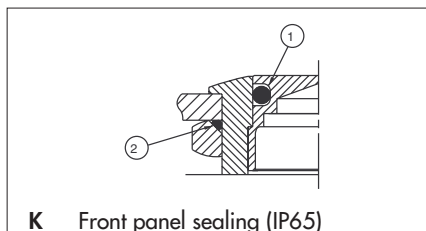

- ① internal gasket
- ② external gasket