

IB and IS series

Sealed momentary pushbutton switches

Distinctive features and specifications



- Snap-in and threaded bushing models
- Compact, light in weight
 - Behind-panel depth of 13 mm (.512) only
 - 50 % reduction in weight compared to metallic models
- Tactile feedback
- Sealed to IP 67

B

ENVIRONMENTAL SPECIFICATIONS

- Degree of protection : IP 67 - See details page B36.
- Shock resistance : 100 g according to IEC 512-4, test 6c
- Vibration resistance : 10-500 Hz - 10 g according to IEC 512-4, test 6d
- Salt spray : IEC 512-6, test 11f
- Operating temperature : -40°C to +85°C

MATERIALS

- Case : thermoplastic UL94-V0
- Plunger : polyamide 6/6
- Bushing/bezel : polyamide 6/6
- Contacts : silver, gold plated
- Terminal seal : epoxy

ELECTRICAL AND GENERAL SPECIFICATIONS

- Max. current/voltage rating with resistive load :
400mA 32VAC - 100mA 50VDC - 125mA 125VAC
- Initial contact resistance : 50 mΩ max.
- Insulation resistance : 1 GΩ min. at 500VDC
- Dielectric strength : 1.000 VAC rms
- Electrical life at full load : 500.000 cycles
- Panel thickness :
 - IB series : 0,8 mm (.031) min. - 1,8 mm (.071) max.
 - IS series : 1,5 mm (.059) min. - 4 mm (.157) max.
- Total travel : 1,5 mm (.059)
- Operating force : 2N to 5N
- Contact bounce : 10 ms
- Mechanical life : 1.000.000 cycles
- Torque : 1,5 Nm max. applied to nut
- Soldering : 300°C max. for 3 seconds

*Example of custom switch:
see end of the series.*

IB and IS series

Sealed momentary pushbutton switches

Overview

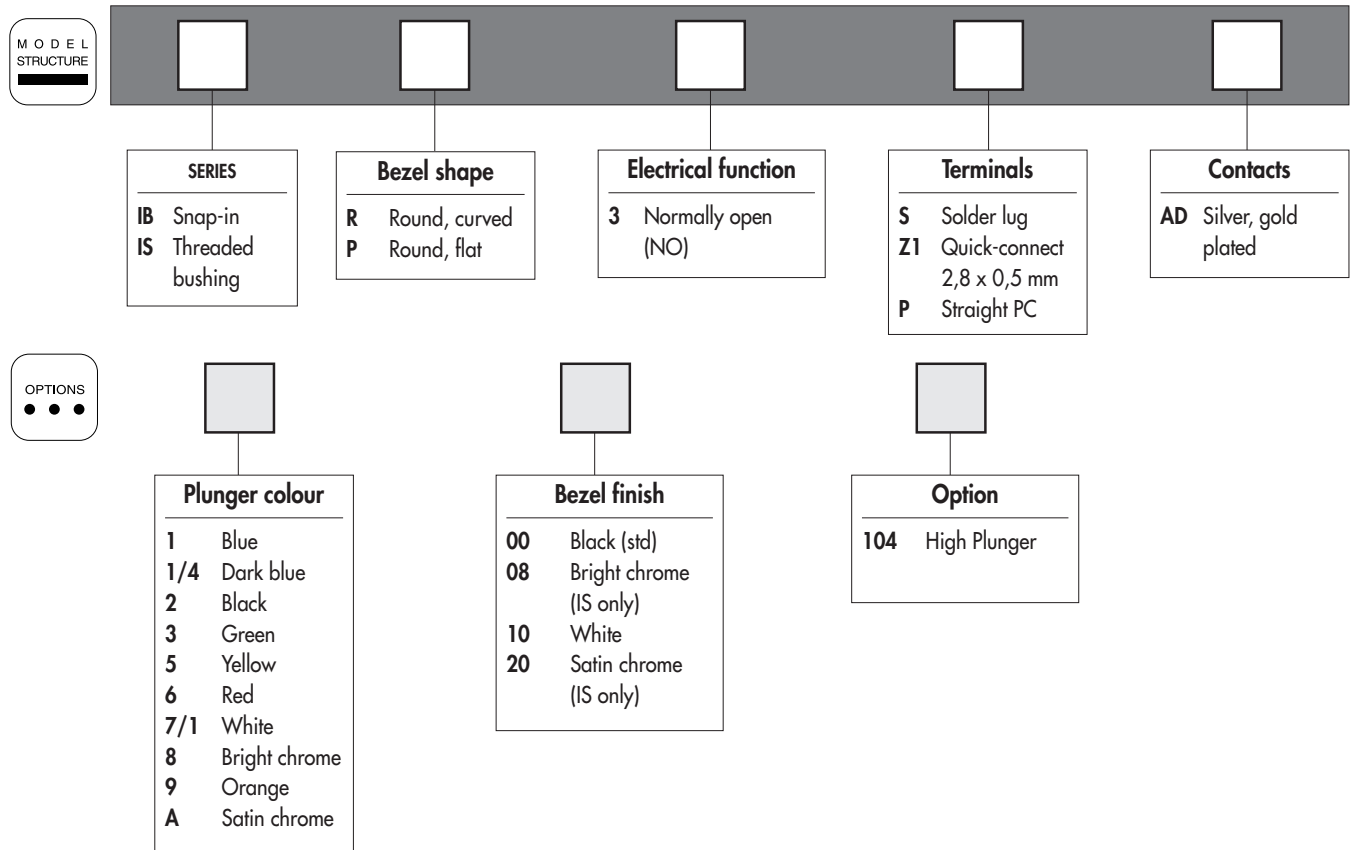

B

ABOUT THIS SERIES

On the following pages, you will find successively :
 - model structure of switches and options in the same order as in above chart

Dimensions : first dimensions are in mm while inches are shown as bracketted numbers.



NOTICE : please note that not all combinations of above numbers are available. Refer to the following pages for further information.



A sealing boot is available to protect the switches against frost and sand. It is presented at the end of the series and in section H.



Mounting accessories : Standard hardware supplied : 1 flat seal (IB series)
 1 hex nut 14 mm (.551) across flats and 1 flat seal (IS series). The hex nut is presented in section I (part number U166).



Packaging unit : 50 pieces

IB and IS series

Sealed momentary pushbutton switches

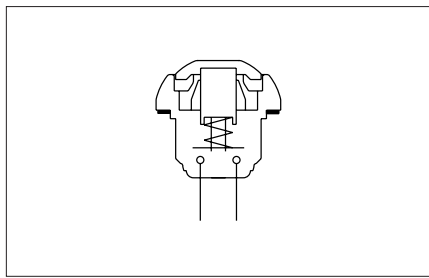

- Ten plunger colours
- Curved or flat actuator
- Antirotation bushing

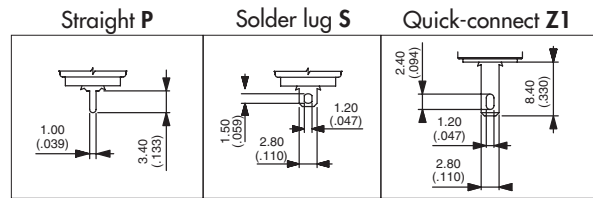

MODEL STRUCTURE

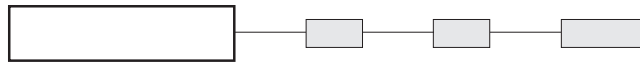

B

Snap-in mounting - solder lugs

→ Flat

Panel thickness : 0,8 mm to 1,8 mm



- Curved actuator
IBR3SAD Normally open
- Flat actuator
IBP3SAD Normally open

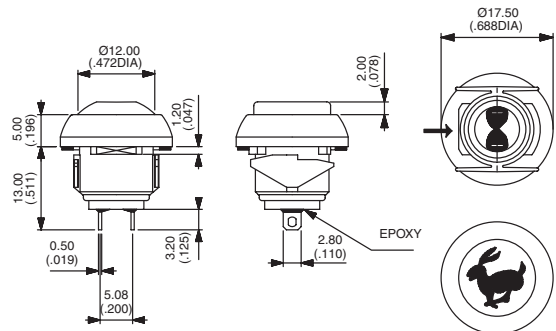

Also available with straight PC : **IB•3PAD** or quick-connect terminals : **IB•3Z1AD**

Mounting by threaded bushing - solder lugs

→ Flat

Panel thickness : 1,5 mm to 4 mm



- ISR3SAD** Normally open

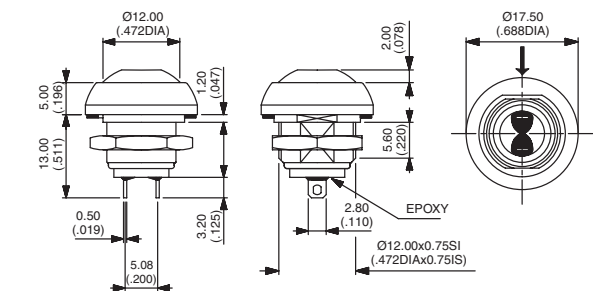

Also available with straight PC : **ISR3PAD** or quick-connect terminals : **ISR3Z1AD**
Also available with flat actuator. On request.

PLUNGER COLOUR



Plunger marking available on IBP models (symbol 10 mm max.). On request.



1 : blue - 1/4 : dark blue - 2 : black - 3 : green - 5 : yellow - 6 : red - 7/1 : white - 8 : bright chrome
9 : orange - A : satin chrome

BUSHING AND BEZEL FINISH



00 : Black (standard)
08 : Bright chrome (IS series only)
10 : White
20 : Satin chrome (IS series only)

IB and IS series

Sealed momentary pushbutton switches

PLUNGER OPTION



104 : High plunger

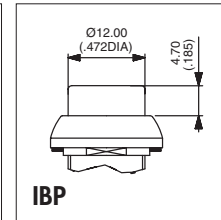
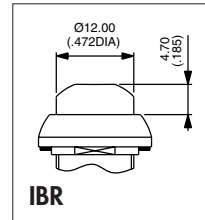

IB SERIES MOUNTING

Panel cut-out

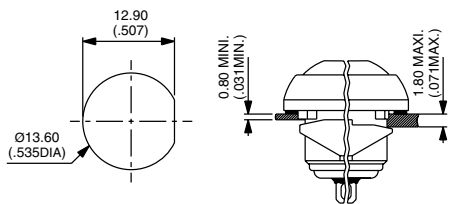

Matrix mounting

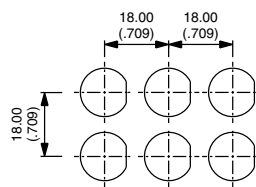

TACTILE FEEDBACK

Cross section

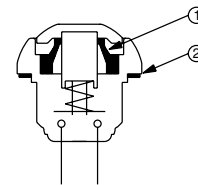

① Elastomeric membrane ② Flat seal

Operating force/travel

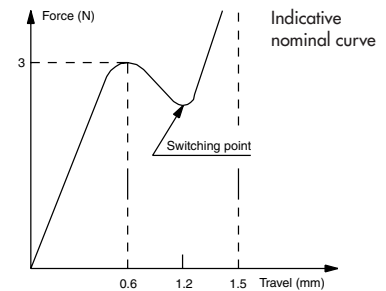

IS SERIES MOUNTING

Panel cut-out

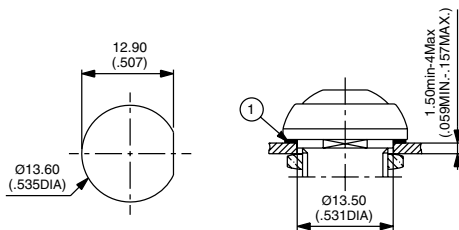

Matrix mounting

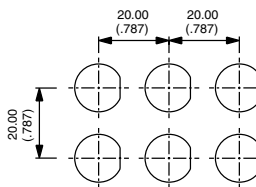

ADDITIONAL SEALING

By silicone boot for protection against frost and abrasion by sand. Order separately.

- transparent : **U5125**
- blue : **U5125-1**
- black : **U5125-2**
- red : **U5125-6**

Operating temperature : -40°C to +125°C
Life expectancy : 500.000 cycles

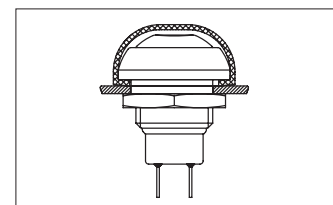
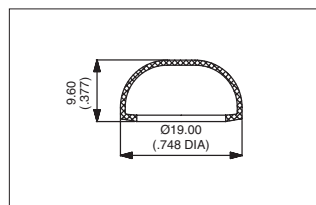

Example of custom switch



ISR3FADB22X1248-01

- Painted bushing and actuator, soft feel
- Wire leads (55 mm) + connector
- Overmolded rear part