



LSH1A



Series HDLS Plug-in: Side Rotary; 1NC
1NO SPDT Snap Action; 0.5 in - 14NPT
conduit

Order Lever Separately

Actual product appearance may vary.

Features

- Wide variety of operating heads
- Field adjustable operating modes, for reduced inventory
- Convenience of on-the-spot adjustment instructions
- Complete choice of circuitry and electrical rating options
- Plug-in and non plug-in versions have identical operating characteristics and are dimensionally interchangeable
- Manifold (rear-wire) version
- Explosion-proof versions
- Low temperature versions to -40°C (-40°F)
- Captive head and body screws
- Designed to withstand seismic shock
- Stainless steel (NEMA 4X) versions
- Pre-leaded cable or pre-wired connector types
- Epoxy filled wash down (NEMA 6P) types
- Completely fluorocarbon (FC) sealed versions

Description

Potential Applications

- Machine Tools
- Material Handling
- Packaging
- Presses
- Pulp and Paper
- Welding
- PLC Interface

Sensing and Control offers the world's most advanced line of MICRO SWITCH™ heavy-duty limit switches. These switches include boss-and-socket head design for secure head-to-body retention, unique all-metal drive train for consistent operating characteristics even at high temperature (lasts longer without the need for frequent adjustment than drive trains with plastic parts,) self-lifting pressure plate terminals save wiring time, easily identified grounding terminal (inside) for compliance with OSHA and other regulatory agency standards, one piece flat gasket (seals better than gaskets that go around curves and corners, does not contact terminal pins to reduce chances of fluid migration,) front mounting and interchangeability of single- and double-pole switches, plug-in and non plug-in with one another and with other switch brands, tracking interchangeability of actuator levers for single- and double-pole switches, plug-in and non plug-in, twin shaft seals for an extra measure of protection, inner FC O-ring seal, outer Buna-N seal (all FC available,) FC shaft and diaphragm seals on side rotary switches, rugged corrosion-resistant zinc head and body are phosphate treated and epoxy finished, exclusive teller tab assures proper torque (when it cannot be moved the lever is tight enough to prevent slippage) and domestic and international conduit taps.

Product Specifications	
Availability	Global
Operating Force (O.F.)	0,19 N m max. [1.7 in lb max.]
Pretravel (P.T.)	9° max.
Overtravel (O.T.)	66° min.
Differential Travel (D.T.)	3° max.
Product Type	MICRO SWITCH™ Heavy-Duty Limit Switches
Actuator	Side Rotary
Lever Style	Lever Not Included - Reference Lever Required Accessory
Circuitry	1NC 1NO Single-Pole Double-Throw, Snap-Action, Double-Break
Ampere Rating	10 A (Thermal)
Supply Voltage	600 Vac and 250 Vdc max.
Housing Material	Zinc Die-Cast
Termination Type	0.5 in - 14NPT conduit
Housing Type	HDLS Plug-in
Series Name	HDLS
Sealing	NEMA 1, 3, 4, 4X, 6, 6P, 12, 13
Approvals	UL listed, CSA Certified, CE Certified, CCC Certified
CSA File #	LR57326/Master Contract 152457
UL File #	E37138
Operating Temperature Range	-1 °C to 121 °C [30 °F to 250 °F]
Comment	Low differential travel and low torque
Agency Approvals and Standards	EN60947-1, EN60947-5-1
UNSPSC Code	302119
UNSPSC Commodity	302119 Switches and controls and relays
Sealed	Industrial

OPERATING CHARACTERISTICS	LSA		LSR		LSN		LSP		LSH	
	MOMENTARY		MOMENTARY LOW TORQUE		MAINTAINED		MOMENTARY LOW PRETRAVEL AND DIFF. TRAVEL		MOMENTARY LOW PRETRAVEL AND LOW TORQUE	
PRETRAVEL(MAX)	1°		1°		1°		1°		1°	
DIFFERENTIAL TRAVEL(MAX)	SINGLE POLE 5°		DOUBLE POLE 7°		40°		SINGLE POLE 3°		DOUBLE POLE 4°	
TOTAL TRAVEL (EEP)	75°		75°		90°		75°		75°	
OPERATING TORQUE(MAX)	4 IN. LBS		1.7 IN. LBS		4 IN. LBS		4 IN. LBS		1.7 IN. LBS	
FULL TRAVEL TORQUE(MAX)	4 IN. LBS		1.7 IN. LBS		4 IN. LBS		4 IN. LBS		1.7 IN. LBS	
OPERATING CHARACTERISTICS	LSU		LSL		LSM		LSF		LSS	
PRETRAVEL(MAX)	5°		18° STEP 1°		18°		18°		NOT APPLICABLE	
OVERTRAVEL(MIN)	SINGLE POLE 2°		DOUBLE POLE 2°		2°		2°		2°	
OPERATING TORQUE(MAX)	4 IN. LBS		4 IN. LBS		4 IN. LBS		12 IN-OZ		5 IN-OZ	
FULL TRAVEL TORQUE(MAX)	4 IN. LBS		4 IN. LBS		4 IN. LBS		12 IN-OZ		5 IN-OZ	

SIDE ROTARY

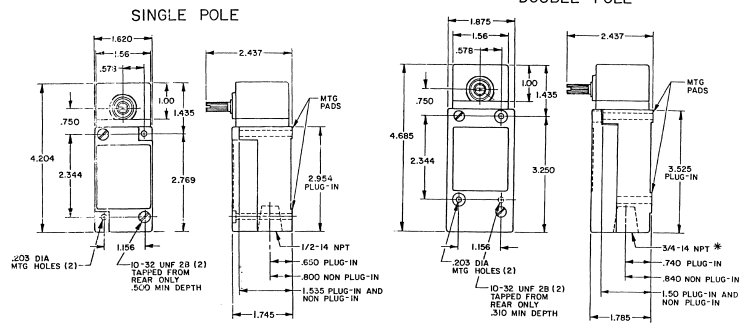

TYPE: LSA1, LSH1, LSN1, LSP1, LSR1, LSA3, LSH3, LSN3, LSP3, LSR3, LSS1, LSF1

TYPE: LSA2, LSH2, LSM2, LSN2, LSP2, LSR2, LSA4, LSH4, LSM4, LSN4, LSP4, LSR4

*LSA6, LSH6, LSM6, LSN6, LSP6, LSR6, LSA7, LSH7, LSM7, LSN7, LSP7, LSR7 HAVE 1/2-14 NPT CONDUIT HOLES

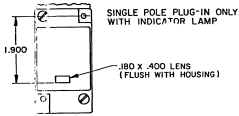

120 LAMP VOLTAGE - TYPE LSA5, LSH5, LSN5, LSP5, LSR5
 240 LAMP VOLTAGE - TYPE LSA8, LSH8, LSN8, LSP8, LSR8

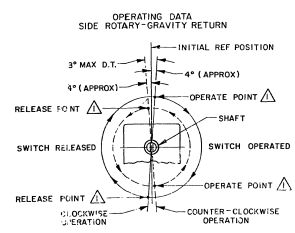
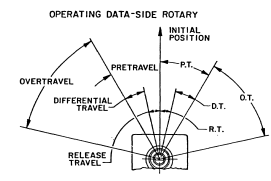

NOTE: OPERATE AND RELEASE POINTS WILL EXCHANGE LOCATIONS IF SHAFT IS ROTATED 180°

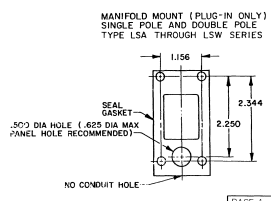

THIS DRAWING COVERS A PRODUCT LINE AND IS THE PROPERTY OF MICRO SWITCH. IT IS TO BE KEPT IN CONFIDENCE AND NOT TO BE COPIED OR USED WITHOUT THE APPROVAL OF MICRO SWITCH.

MICRO SWITCH
 a Honeywell Division

SWITCH - ENCLOSED LSA-LSW SERIES
 CHART 1

PAGE 1 OF 10
 UNLESS OTHERWISE SPECIFIED TOLERANCES ARE:
 ONE PLACE .003 ±.003
 TWO PLACES .0008 ±.001
 THREE PLACES .0001 ±.0005
 ANGLES .5°

THIS DRAWING IS NOT TO BE COPIED OR USED WITHOUT THE APPROVAL OF MICRO SWITCH.

SIDE ROTARY CAM TRACKING

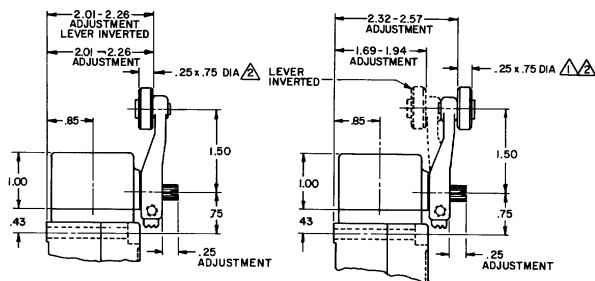

LSZ51 TYPE LEVERS

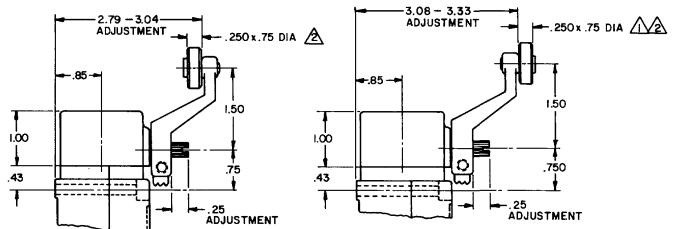

LSZ55 TYPE LEVERS

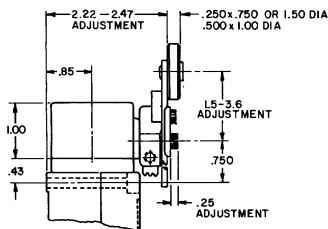

LSZ52 TYPE LEVER

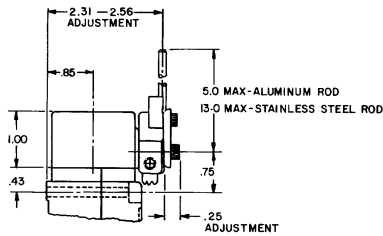

LSZ54 TYPE LEVER

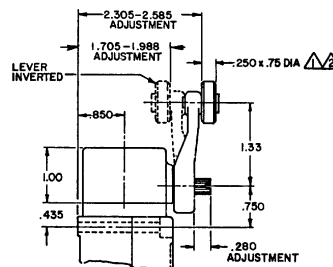

OPEN MOUNTED ROLLER

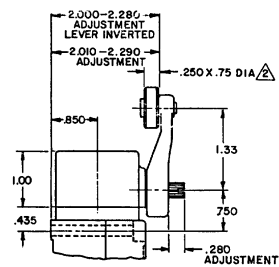

CLOSED MOUNTED ROLLER

LSZ59 TYPE LEVERS

NOTES

- △ ALSO AVAILABLE IN Ø.250 X 1.500 NYLON, BUT LEVER CANNOT BE INVERTED
- △ FOR ADDITIONAL ROLLER WIDTHS AND/OR DIAMETERS REFER TO "M" DRAWING
- 3 - FOR ADDITIONAL TYPES OF ROLLERS AND LEVERS REFER TO LSZ CHART 1 "M" DRAWING

REVISIONS
 LSA-LSW SERIES CHART 1
 PAGE 2 OF 10
 ISSUE 12
 DATE 15 JUN 84
 DRAWN BY
 CHECKED BY
 APPROVED BY
 RAISTER
 MICRO SWITCH
 HONEYWELL DIVISION
 MILWAUKEE, WI 53180
 PHONE (414) 761-1000
 TELETYPE (414) 761-1001
 FAX (414) 761-1002
 MAIL ROOM (414) 761-1003
 SERVICE (414) 761-1004
 SALES (414) 761-1005
 ENGINEERING (414) 761-1006
 PRODUCTION (414) 761-1007
 QUALITY CONTROL (414) 761-1008
 MATERIALS (414) 761-1009
 PURCHASING (414) 761-1010
 DISTRIBUTION (414) 761-1011
 GENERAL (414) 761-1012
 FAX (414) 761-1013

THIS DRAWING COVERS A PROPRIETARY ITEM AND IS THE PROPERTY OF MICRO SWITCH, A DIVISION OF HONEYWELL. THIS DRAWING IS NOT TO BE COPIED OR USED WITHOUT THE APPROVAL OF MICRO SWITCH.		CATALOG LISTING LSA-LSW SERIES CHART 1
MICRO SWITCH a Honeywell Division FED. MFG. CODE 91929	SWITCH - ENCLOSED	THIRD ANGLE PROJECTION SCALE: NONE DO NOT SCALE PRINT UNLESS OTHERWISE SPECIFIED TOLERANCES ARE: ONE PLACE (Ø) ±.030 TWO PLACES (Ø) ±.015 THREE PLACES (Ø) ±.005 ANGLES ± WEIGHT