

V

Miniature Snap Action Switch



- Industry standard design with 10/15 Amp ratings
- Long mechanical life of 50,000,000 operations minimum
- Available in either thermoplastic or thermosetting resin
- Can be used to interrupt current when doors are opened or closed

Part	Rated Resistive Load - Switch	Actuator types	Contact form	Operating Force	Seal type	Termination Style	Service Life - Electrical (Min. @ Rated Loads)
V-10G-1A4-K	10A @ 250VAC	Pin plunger	SPDT	100g	Unsealed	Solder / 187 Quick Connect	300,000 ops
V-10G-1A5-K	10A @ 250VAC	Pin plunger	SPDT	200g	Unsealed	Solder / 187 Quick Connect	300,000 ops
V-10G-1B4-K	10A @ 250VAC	Pin plunger	SPDT	100g	Unsealed	Screw Terminals	300,000 ops
V-10G-1B5-K	10A @ 250VAC	Pin plunger	SPDT	200g	Unsealed	Screw Terminals	300,000 ops
V-10G-1C24-K	10A @ 250VAC	Pin plunger	SPDT	100g	Unsealed	187 Quick Connect	300,000 ops
V-10G-1C25-K	10A @ 250VAC	Pin plunger	SPDT	200g	Unsealed	187 Quick Connect	300,000 ops
V-10G-1C4-K	10A @ 250VAC	Pin plunger	SPDT	100g	Unsealed	250 Quick Connect	300,000 ops
V-10G-2C24-K	10A @ 250VAC	Pin plunger	SPST-NC	100g	Unsealed	187 Quick Connect	300,000 ops
V-10G-2C25-K	10A @ 250VAC	Pin plunger	SPST-NC	200g	Unsealed	187 Quick Connect	300,000 ops
V-10G-3C24-K	10A @ 250VAC	Pin plunger	SPST-NO	100g	Unsealed	187 Quick Connect	300,000 ops
V-10G-3C25-K	10A @ 250VAC	Pin plunger	SPST-NO	200g	Unsealed	187 Quick Connect	300,000 ops
V-10G-3C4-K	10A @ 250VAC	Pin plunger	SPST-NO	100g	Unsealed	250 Quick Connect	300,000 ops

Snap Action Switch

V

General Purpose Snap Action Switch

- Industry standard design with 10/15 A ratings
- Long service life of 50,000,000 operations minimum (mechanical)
- RoHS Compliant

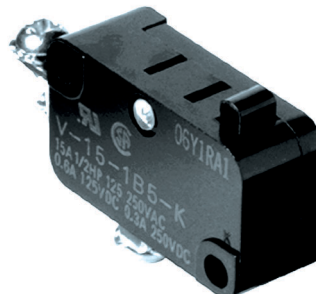

Ordering Information

■ Thermoset Material

(●: standard. ○: available on request)

Remarks	Ratings	Common terminal position	Contact gap		Terminal shape (see note)					OF max					Model
			1 mm	0.5 mm	A	C2	C	B	E	15	25	100	200	400	
Mounted with 2.9 mm dia. screws. The switch unit is housed in a thermoset case, and has high versatility in applications.	15 A, 250 V	Bottom	○	●	●	●	○	○	○	-	-	○	●	○	V-15
	10 A, 250 V	Bottom	○	●	●	●	○	○	○	-	-	●	●	-	V-10

Note: A: Solder/quick connect terminal (#187)







C2: Quick connect terminal (#187)

C: Quick connect terminal (#250)

B: Screw terminal

E: Short solder terminal

Ordering Information - continued from previous page

Actuator	Common terminal position	Contact form	Connect terminal	Model		
				Rated current		
				15 A	10 A	
				200 grams	200 grams	100 grams
Pin plunger 	Bottom	SPDT	A	V-15G-1A5-K	V-10G-1A5-K	V-10G-1A4-K
			C2	V-15G-1C25-K	V-10G-1C25-K	V-10G-1C24-K
			C	V-15G-1C5-K	—	—
			B	V-15G-1B5-K	V-10G-1B5-K	V-10G-1B4-K
			E	V-15G-1E5-K	—	V-10G-1E4-K
		SPST-NC	A	V-15G-2A5-K	V-10G-2A5-K	V-10G-2A4-K
			C2	V-15G-2C25-K	V-10G-2C25-K	V-10G-2C24-K
			C	V-15G-2C5-K	—	—
		SPST-NO	A	V-15G-3A5-K	V-10G-3A5-K	V-10G-3A4-K
	C2		V-15G-3C25-K	V-10G-3C25-K	V-10G-3C24-K	
	C		V-15G-3C5-K	—	—	
	Side	SPDT	A	V-15G-4A5-K	V-10G-4A5-K	V-10G-4A4-K
B			—	V-10G-5A5-K	V-10G-5A4-K	
A			V-15G-6A5-K	V-10G-6A5-K	V-10G-6A4-K	
Short hinge lever 	Bottom	SPDT	A	—	V-10G1-1A5-K	V-10G1-1A4-K
			C2	V-15G1-1C25-K	V-10G1-1C25-K	V-10G1-1C24-K
			B	—	V-10G1-1B5-K	V-10G1-1B4-K
			E	V-15G1-1E5-K	V-10G1-1E5-K	V-10G1-1E4-K
Hinge lever 	Bottom	SPDT	A	V-15G2-1A5-K	V-10G2-1A5-K	V-10G2-1A4-K
			C2	V-15G2-1C25-K	V-10G2-1C25-K	V-10G2-1C24-K
			B	—	V-10G2-1B5-K	V-10G2-1B4-K
			E	V-15G2-1E5-K	V-10G2-1E5-K	—
Long hinge lever 	Bottom	SPDT	A	V-15G3-1A5-K	V-10G3-1A5-K	V-10G3-1A4-K
			C2	V-15G3-1C25-K	V-10G3-1C25-K	V-10G3-1C24-K
			B	V-15G3-1B5-K	V-10G3-1B5-K	V-10G3-1B4-K
			E	—	V-10G3-1E5-K	V-10G3-1E4-K
Simulated roller lever 	Bottom	SPDT	A	V-15G4-1A5-K	V-10G4-1A5-K	V-10G4-1A4-K
			C2	V-15G4-1C25-K	V-10G4-1C25-K	V-10G4-1C24-K
			B	—	V-10G4-1B5-K	V-10G4-1B4-K
			E	—	V-10G4-1E5-K	V-10G4-1E4-K
Short hinge roller lever 	Bottom	SPDT	A	V-15G5-1A5-K	V-10G5-1A5-K	V-10G5-1A4-K
			C2	V-15G5-1C25-K	V-10G5-1C25-K	V-10G5-1C24-K
			B	V-15G5-1B5-K	V-10G5-1B5-K	V-10G5-1B4-K
Hinge roller lever 	Bottom	SPDT	A	V-15G6-1A5-K	V-10G6-1A5-K	V-10G6-1A4-K
			C2	V-15G6-1C25-K	—	V-10G6-1C24-K
			B	V-15G6-1B5-K	V-10G6-1B5-K	V-10G6-1B4-K
			E	V-15G6-1E5-K	V-10G6-1E5-K	V-10G6-1E4-K

- Note:** 1. For SPST-NC and SPST-NO with levers consult Omron.
 2. An insulation barrier is available upon request for thermoplastic types.

Specifications

■ Characteristics

		V-15	V-10
Operating speed		0.1 mm to 1 m/second (0.004 to 39.4 in/second) at pin plunger	
Operating frequency	Mechanical	600 operations per minute	
	Electrical	60 operations per minute	
Contact resistance		15 mΩ max. (initial)	30 mΩ max. (initial)
Insulation resistance		100 MΩ min. at 500 VDC	
Dielectric strength (VAC)		1,000 VAC, between non-continuous terminals 1,500 VAC, between each terminal and ground	
Vibration (see note 2)	Malfunction durability	10 to 55 Hz, 1.5 mm double amplitude	
Shock (see note 2)	Mechanical durability	1,000 m/s ² min. (approx. 100 g)	
	Malfunction durability	300 m/s ² min. (approx. 30 g)	200 m/s ² min. (approx. 20 g)
Ambient temperature	Operating	-25° to 80° C	
Humidity	Operating	85% RH max	
Service life	Mechanical	50,000,000 operations min.	
	Electrical	100,000 operations min.	300,000 operations min.
Weight		Approx. 6.2 g (pin plunger type)	

Note: 1. Data shown are of initial value.
2. The values indicated here are of the pin plunger type.

■ Operating Characteristics

Characteristics	Part number					
	V-15G-1□5-K V-10G-1□5-K	V-10G-1□4-K	V-15G-1□5-K V-10G-1□5-K	V-10G1-1□4-K	V-15G2-1□5-K V-10G2-1□5-K	V-10G2-1□4-K
OF max.	200 g	100 g	200 g	100 g	125 g	60 g
RF min.	50 g	20 g	50 g	15 g	14 g	6 g
PT max.	1.2 mm (0.05 in)		1.5 mm (0.06 in)		3.3 mm (0.13 in)	
OT min.	1.3 mm (0.05 in)		1.0 mm (0.04 in)		2.3 mm (0.09 in)	
MD max.	0.3 mm (0.01 in)		0.5 mm (0.02 in)		0.8 mm (0.03 in)	
OP	14.7±0.4 mm (0.58±0.02 in)		15.2±0.5 mm (0.60±0.02 in)		15.2 ^{+2.6} _{-3.2} mm (0.60 ^{+0.10} _{-0.13} in)	15.2±1.2 mm (0.60±0.05 in)

Characteristics	Part number							
	V-15G3-1□5-K V-10G3-1□5-K	V-10G3-1□4-K	V-15G5-1□5-K V-10G5-1□5-K	V-10G4-1□4-K	V-15G5-1□5-K V-10G5-1□5-K	V-10G5-1□4-K	V-15G6-1□5-K V-10G6-1□5-K	V-10G6-1□4-K
OF max.	70 g	35 g	125 g	60 g	240 g	120 g	125 g	60 g
RF min.	6 g	–	14 g	6 g	50 g	15 g	14 g	6 g
PT max.	9.0 mm (0.35 in)	7.6 mm (0.30 in)	3.3 mm (0.13 in)		1.5 mm (0.06 in)		3.3 mm (0.13 in)	
OT min.	3.0 mm (0.12 in)	3.2 mm (0.13 in)	2.3 mm (0.09 in)		1.0 mm (0.04 in)		2.3 mm (0.09 in)	
MD max.	2.0 mm (0.08 in)		0.8 mm (0.03 in)		0.5 mm (0.02 in)		0.8 mm (0.03 in)	
OP	15.2±2.6 mm (0.60±0.10 in)		18.7±1.2 mm (0.74±0.05 in)		20.7±0.6 mm (0.81±0.02 in)		20.7±1.6 mm (0.81±0.06 in)	

Operating Characteristics - V Series Accessories

Part number	VAL	VAL2	VAV	VAV2	VAM	VAM-1
Switch	V-15G-1A5-K					
OF max.	230 g		35 g	75 g	200 g	300 g
RF min.	50 g		4 g	9 g	30 g	40 g
OT max.	0.8 mm (0.03 in)		3.6 mm (0.14 in)	1.5 mm (0.06 in)	7 mm (0.28 in)	5 mm (0.20 in)
MD min.	0.4 mm (0.02 in)		4.7 mm (0.19 in)	1.2 mm (0.05 in)	7 mm (0.28 in)	6 mm (0.24 in)
FP max.	17 mm (0.67 in)	22.6 mm (0.89 in)	–	–	45 mm (1.78 in)	47 mm (1.85 in)
OP	14.9±0.5 mm (0.59±0.02 in)	20.5±0.5 mm (0.81±0.02 in)	Approx. 10.6 mm (0.42 in)	18.6±1.6 mm (0.73±0.06 in)	20±9 mm (0.79±0.35 in)	30±5 mm (1.18±0.20 in)

Ratings

Type	Rated voltage	Non-inductive load (A)				Inductive load (A)				Inrush current Non-inductive & Inductive NC/NO
		Resistive load		Lamp load		Inductive load		Motor load		
		NC	NO	NC	NO	NC	NO	NC	NO	
15 A	250 VAC	15	15	2	2	10	10	3	3	36 A max.
	125 VDC	0.1	0.1	–	–	–	–	–	–	
10 A	250 VAC	10	10	1.5	1.5	6	6	2	2	24 A max.
	125 VDC	0.1	0.1	–	–	–	–	–	–	

- Note:** 1. Inductive load has a power factor of 0.4 min. (AC) and a time constant of 7 milliseconds max. (DC).
 2. Lamp load has an inrush current of 10 times the steady-state current, while motor load has an inrush current of 6 times the steady-state current.

Contact Form

Common terminal position	Contact form		
	SPDT	SPST-NC*	SPST-NO*
Bottom type			
Side type			

* The SPST-NC and SPST-NO contact form types listed in the ordering information tables are for Pin Plunger models only. For information concerning lever models consult Omron.

Application load range

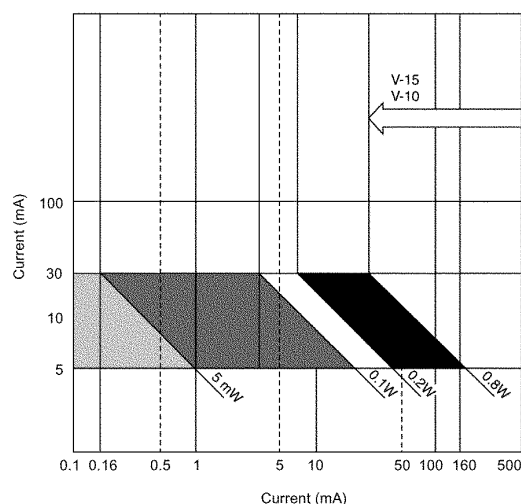

Approvals

UL (File No. E41515), CSA (File No. LR21642) IEC 1058-1, EN conforms 61058-1

OF max.	Thermoset material	
	V-15	V-10
100 g	UL CSA	UL CSA
200 g	UL CSA	UL CSA
400 g	UL CSA	– –

- Note:** 1. The rated values approved by each of the safety standards (e.g. UL, CSA) may be different from the performance characteristics individually defined in this catalog.
 2. Models approved by DEMKO, NEMKO, BEAB and SETI are also available. Consult OMRON for detailed information.

Engineering Data

Mechanical service life
V-15, V-10

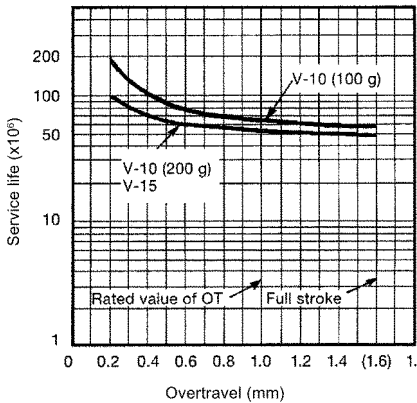

Electrical service life
V-15

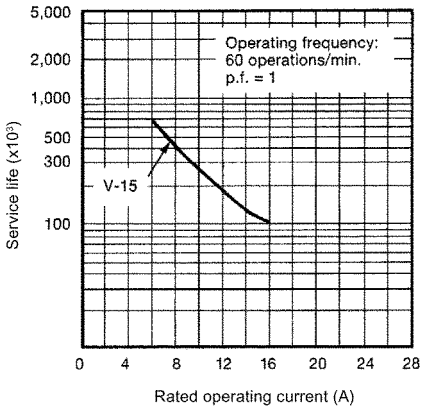

Electrical service life
V-10

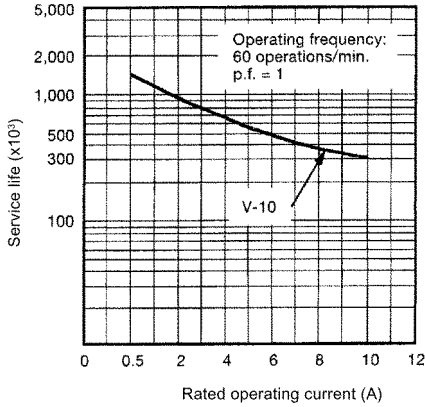

Dimensions

Unit: mm (inch)

The following figures show the models having quick connect terminals in the #250 series at the bottom of the case. For other terminals, please refer to "Terminals."

Note: Unless otherwise specified, a tolerance of ± 0.4 mm applies to all dimensions.

Pin Plunger

- V-15G-1□5-K
- V-10G-1□5-K
- V-10G-1□4-K

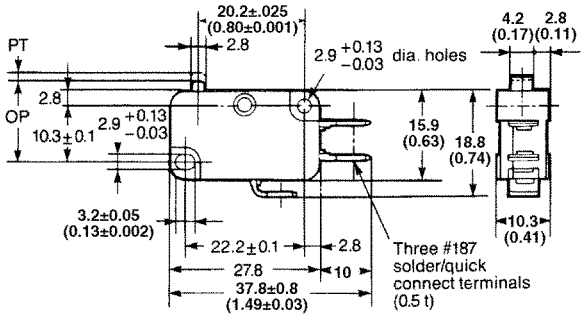

Short Hinge Lever

- V-15G1-1□5-K
- V-10G1-1□5-K
- V-10G1-1□4-K

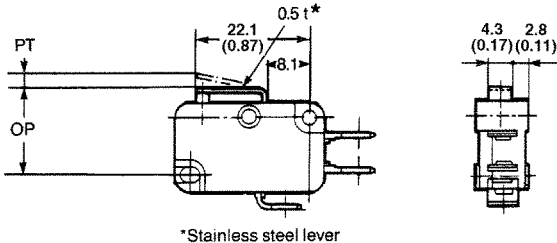

■ Hinge Lever

- V-15G2-1□5-K
- V-10G2-1□5-K
- V-10G2-1□4-K

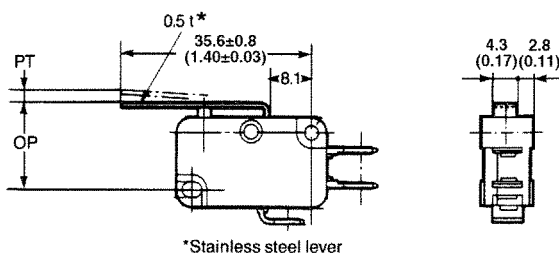

■ Long Hinge Lever

- V-15G3-1□5-K
- V-10G3-1□5-K
- V-10G3-1□4-K

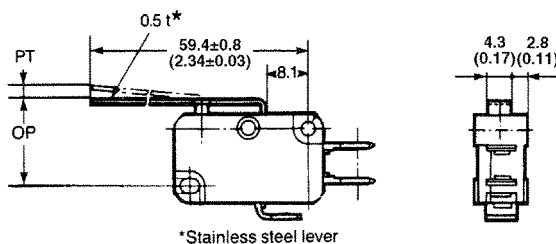

■ Simulated Roller Lever

- V-15G4-1□5-K
- V-10G4-1□5-K
- V-10G4-1□4-K

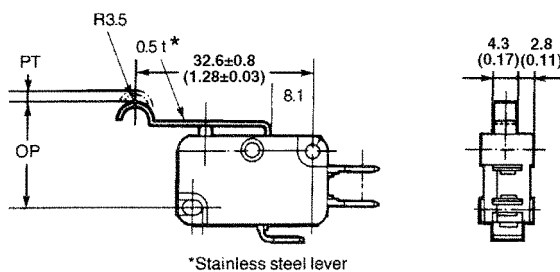

■ Short Hinge Roller Lever

- V-15G5-1□5-K
- V-10G5-1□5-K
- V-10G5-1□4-K

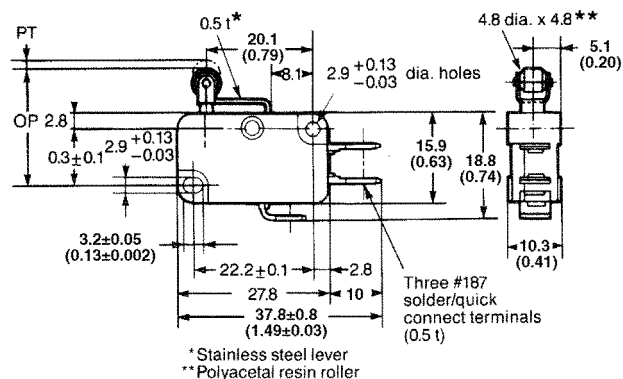

■ Hinge Roller Lever

- V-15G6-1□5-K
- V-10G6-1□5-K
- V-10G6-1□4-K

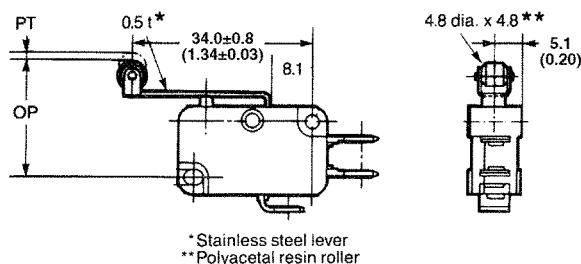

■ Terminals

General purpose type

**Solder terminal (A)
(or quick connect terminals
#187 series)**

**Quick connect terminal (C2)
(#187 series)**

**Quick connect terminal (C)
(#250 series)**

Common terminal position

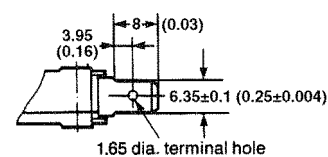
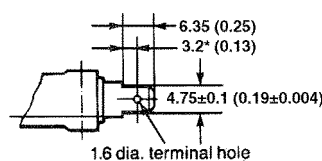
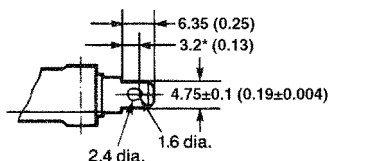

*Indicates the length to the center of the 1.6 dia. holes.

Bottom type

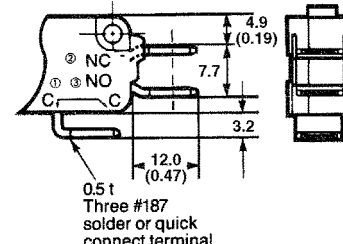
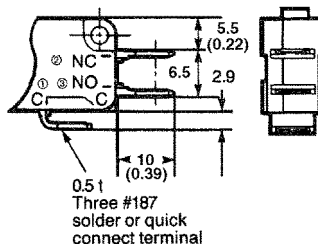
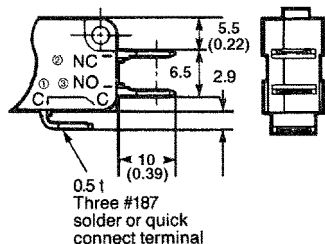

Side type

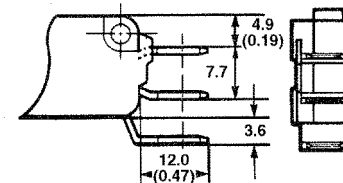
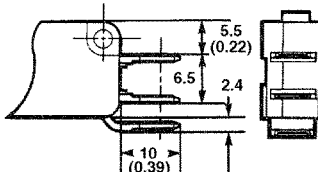
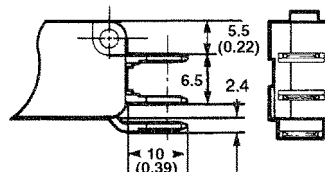

Common terminal position

Short solder terminal (E)

Screw Terminal (B)

Bottom terminal

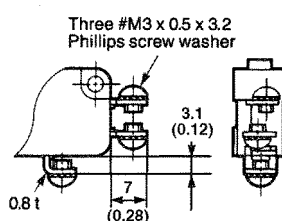
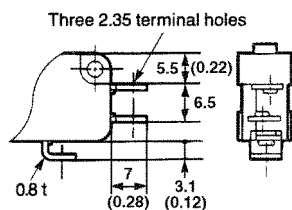

Accessory Dimensions

■ Actuator Accessories

Three series of actuators are optionally available: VAL, VAM, and VAV series.

The actuators in the VAL series are designated for rotary cam operations.

The VAM series actuators are highly resistive to vibration and shock; so, they are ideal for machine tools and automatic doors where the switches are subject to heavy vibration or shock.

The VAV series actuators are highly sensitive to force. Therefore, they should be used in an application where the operating force to be applied to the switch is critical.

All these actuators can be mounted on all OMRON snap action switches having the following dimensions.

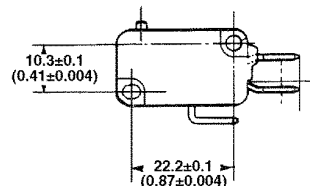

- Note:**
1. Unless otherwise specified, a tolerance of ± 0.4 mm applies to all dimensions.
 2. The operating characteristics above apply when the actuator is attached to V-15-1A5-K basic switch. For any other models, consult OMRON.