

## D2F



### Ultra Subminiature Snap Action Basic Switch

- Super Compact, ideal for PCB mounting
- Self-clinching PCB, right-angled, left-angled, and solder terminals available
- Dual spring reverse action mechanism ensures long service life
- Flux penetration prevented by using an insert terminal and height difference at case bottom
- Switches a range of loads from .1 amp to 3 amps
- Ideal for a variety of applications from household appliances to office equipment
- ROHS compliant

Part	Rated Resistive Load - Switch	Actuator types	Contact form	Operating Force	Seal type	Termination Style	Service Life - Electrical (Min. @ Rated Loads)
D2F-01	0.1A @ 30VDC	Pin plunger	SPDT	150g	Flux protection	Through-Hole PCB - Straight	30,000 ops
D2F-01-A	0.1A @ 30VDC	Pin plunger	SPDT	150g	Flux protection	Through-Hole PCB - parallel right	30,000 ops
D2F-01-A1	0.1A @ 30VDC	Pin plunger	SPDT	150g	Flux protection	Through-Hole PCB - parallel left	30,000 ops
D2F-01-D	0.1A @ 30VDC	Pin plunger	SPDT	150g	Flux protection	Solder	30,000 ops
D2F-01-T	0.1A @ 30VDC	Pin plunger	SPDT	150g	Flux protection	Through-Hole PCB - Straight, Self supporting	30,000 ops
D2F-01F	0.1A @ 30VDC	Pin plunger	SPDT	75g	Flux protection	Through-Hole PCB - Straight	30,000 ops
D2F-01F-A	0.1A @ 30VDC	Pin plunger	SPDT	75g	Flux protection	Through-Hole PCB - parallel right	30,000 ops
D2F-01F-A1	0.1A @ 30VDC	Pin plunger	SPDT	75g	Flux protection	Through-Hole PCB - parallel left	30,000 ops

<b>D2F-01F-D</b>	0.1A @ 30VDC	Pin plunger	SPDT	75g	Flux protection	Solder	30,000 ops
<b>D2F-01F-T</b>	0.1A @ 30VDC	Pin plunger	SPDT	75g	Flux protection	Through-Hole PCB - Straight, Self supporting	30,000 ops
<b>D2F-01FL</b>	0.1A @ 30VDC	Hinge lever	SPDT	25g	Flux protection	Through-Hole PCB - Straight	30,000 ops
<b>D2F-01FL-A</b>	0.1A @ 30VDC	Hinge lever	SPDT	25g	Flux protection	Through-Hole PCB - parallel right	30,000 ops
<b>D2F-01FL-D</b>	0.1A @ 30VDC	Hinge lever	SPDT	25g	Flux protection	Solder	30,000 ops
<b>D2F-01FL-T</b>	0.1A @ 30VDC	Hinge lever	SPDT	25g	Flux protection	Through-Hole PCB - Straight, Self supporting	30,000 ops
<b>D2F-01L</b>	0.1A @ 30VDC	Hinge lever	SPDT	80g	Flux protection	Through-Hole PCB - Straight	30,000 ops
<b>D2F-01L-A</b>	0.1A @ 30VDC	Hinge lever	SPDT	80g	Flux protection	Through-Hole PCB - parallel right	30,000 ops
<b>D2F-01L-A1</b>	0.1A @ 30VDC	Hinge lever	SPDT	80g	Flux protection	Through-Hole PCB - parallel left	30,000 ops
<b>D2F-01L-D</b>	0.1A @ 30VDC	Hinge lever	SPDT	80g	Flux protection	Solder	30,000 ops

Part	Rated Resistive Load - Switch	Actuator types	Contact form	Operating Force	Seal type	Termination Style	Service Life - Electrical (Min. @ Rated Loads)
<b>D2F-01L-T</b>	0.1A @ 30VDC	Hinge lever	SPDT	80g	Flux protection	Through-Hole PCB - Straight, Self supporting	30,000 ops
<b>D2F-01FL2</b>	0.1A @ 30VDC	Roller lever	SPDT	40g	Flux protection	Through-Hole PCB - Straight	30,000 ops
<b>D2F-01FL2-D</b>	0.1A @ 30VDC	Roller lever	SPDT	40g	Flux protection	Solder	30,000 ops
<b>D2F-01L2</b>	0.1A @ 30VDC	Roller lever	SPDT	80g	Flux protection	Through-Hole PCB - Straight	30,000 ops
<b>D2F-01L2-A</b>	0.1A @ 30VDC	Roller lever	SPDT	80g	Flux protection	Through-Hole PCB - parallel	30,000 ops





# Snap Action Switch D2F

## Subminiature Snap Action Switch

- Super compact, ideal for PCB mounting
- Switches 3 A loads (general-purpose), 1 A loads (low force general-purpose) and 0.1 A loads (microvoltage/microcurrent)
- Long life span assured by high-precision dual spring reverse-action mechanism
- Flux penetration prevented by using an insert terminal and allowing a height difference at the case bottom
- Ideal for a wide variety of applications from household appliances and office equipment to audio equipment and communications equipment
- RoHS Compliant



## Ordering Information

Actuator	Contact type	Model	Contact OF	Model				
				Terminal type				
				PCB	Self-supporting	Soldered	Right-angle	Left-angle
Pin plunger 	Microvoltage/current	Low force	75 g	D2F-01F	D2F-01F-T	D2F-01F-D	D2F-01F-A	D2F-01F-A1
		Standard	150 g	D2F-01	D2F-01-T	D2F-01-D	D2F-01-A	D2F-01-A1
	General-purpose	Low force	75 g	D2F-F	D2F-F-T	D2F-F-D	D2F-F-A	D2F-F-A1
		Standard	150 g	D2F	D2F-T	D2F-D	D2F-A	D2F-A1
Hinge lever 	Microvoltage/current	Low force	25 g	D2F-01FL	D2F-01FL-T	D2F-01FL-D	D2F-01FL-A	D2F-01FL-A1
		Standard	80 g	D2F-01L	D2F-01L-T	D2F-01L-D	D2F-01L-A	D2F-01L-A1
	General-purpose	Low force	25 g	D2F-FL	D2F-FL-T	D2F-FL-D	D2F-FL-A	D2F-FL-A1
		Standard	80 g	D2F-L	D2F-L-T	D2F-L-D	D2F-L-A	D2F-L-A1
Simulated roller lever 	Microvoltage/current	Low force	40 g	D2F-01FL3	D2F-01FL3-T	D2F-01FL3-D	D2F-01FL3-A	D2F-01FL3-A1
		Standard	80 g	D2F-01L3	D2F-01L3-T	D2F-01L3-D	D2F-01L3-A	D2F-01L3-A1
	General-purpose	Low force	40 g	D2F-FL3	D2F-FL3-T	D2F-FL3-D	D2F-FL3-A	D2F-FL3-A1
		Standard	80 g	D2F-L3	D2F-L3-T	D2F-L3-D	D2F-L3-A	D2F-L3-A1
Roller lever 	Microvoltage/current	Low force	40 g	D2F-01FL2	—	D2F-01FL2-D	D2F-01FL2-A	D2F-01FL2-A1
		Standard	80 g	D2F-01L2	D2F-01L2-T	D2F-01L2-D	D2F-01L2-A	D2F-01L2-A1
	General-purpose	Low force	40 g	D2F-FL2	D2F-FL2-T	D2F-FL2-D	D2F-FL2-A	D2F-FL2-A1
		Standard	80 g	D2F-L2	D2F-L2-T	D2F-L2-D	D2F-L2-A	D2F-L2-A1

# Specifications

## ■ Characteristics

Operating speed		1 to 500 mm/second (0.04 to 19.7 in./second)
Operating frequency	Mechanical	200 operations per minute (pin plunger actuator type)
	Electrical	30 operations per minute (pin plunger actuator type)
Contact resistance	General-purpose type	30 mΩ max. (initial)
	Microvoltage/ microcurrent load type	100 mΩ max. (initial)
Insulation resistance		100 MΩ min. at 500 VDC
Dielectric strength		600 VAC, 50/60 Hz for 1 minute between terminals of same polarity 1,500 VAC, 50/60 Hz for 1 minute between current-carrying parts and ground
Vibration	Malfunction durability	10 to 55 Hz, 1.5 mm double amplitude
Shock	Malfunction durability	300 m/s <sup>2</sup> min. (approx. 30 g min.)
Ambient temperature	Operating	-25° to 65° C with no icing
Humidity	Operating	45% to 85% at 5° to 35° C
Service life	Mechanical	1 million operations min. (OT: full stroke)
	Electrical	30,000 operations min. (rated load)
Weight		Approx. 0.5 g

Note: Data shown are of initial value.

## ■ Operating Characteristics

Characteristics	Part number				
	D2F-01F-□, D2F-F-□	D2F-01-□, D2F-□	D2F-01FL-□, D2F-FL-□	D2F-01L-□, D2F-L-□	D2F-01FL3-□, D2F-FL3-□
OF max.	75 g	150 g	25 g	80 g	40 g
RF min.	5 g	20 g	2 g	5 g	2 g
PT max.	0.5 mm (0.020 in)	0.5 mm (0.020 in)	—	—	—
OT min.	0.25 mm (0.009 in)	0.25 mm (0.009 in)	0.55 mm (0.022 in)	0.55 mm (0.022 in)	0.5 mm (0.020 in)
MD max.	0.12 mm (0.005 in)	0.12 mm (0.005 in)	0.5 mm (0.020 in)	0.5 mm (0.020 in)	0.45 mm (0.177 in)
OP	5.5 ± 0.3 mm (0.22 ± 0.012 in)	5.5 ± 0.3 mm (0.22 ± 0.012 in)	6.8 ± 1.5 mm (0.267 ± 0.059 in)	6.8 ± 1.5 mm (0.267 ± 0.059 in)	8.5 ± 1.2 mm (0.335 ± 0.047 in)
FP max.	—	—	10 mm (0.394 in)	10 mm (0.394 in)	13 mm (0.512 in)

Characteristics	Part number		
	D2F-01L3-□, D2F-L3-□	D2F-01FL2-□, D2F-FL2-□	D2F-01L2-□, D2F-L2-□
OF max.	80 g	40 g	80 g
RF min.	5 g	2 g	5 g
PT max.	—	—	—
OT min.	0.5 mm (0.020 in)	0.55 mm (0.022 in)	0.55 mm (0.022 in)
MD max.	0.45 mm (0.177 in)	0.5 mm (0.020 in)	0.5 mm (0.020 in)
OP	8.5 ± 1.2 mm (0.335 ± 0.047 in)	13 ± 2.0 mm (0.512 ± 0.079 in)	13 ± 2.0 mm (0.512 ± 0.079 in)
FP max.	13 mm (0.512 in)	16.5 mm (0.650 in)	16.5 mm (0.650 in)

## ■ Ratings

Rated Voltage	Resistive load			
	Microvoltage/current		General-purpose	
	Low force	Standard	Low force	Standard
125 VAC	—	—	1 A	3 A
30 VDC	0.1 A	0.1 A	0.5 A	2 A

Note: When using an inductive load or motor load, consult OMRON.

## ■ Contact Form

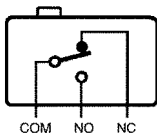

## ■ Approvals

UL (File No. E41515), CSA (File No. LR21642), EN conforms 61058-1

Type	Rating
D2F Series, D2F-01 Series	3 A, 125 VAC 1 A, 125 VAC 2 A, 30 VDC 0.5 A, 30 VDC 0.1 A, 30 VDC

**Note:** The rated values approved by each of the safety standards (e.g.UL,CSA) may be different from the performance characteristics individually defined in this catalog.

## Engineering Data

Mechanical service life

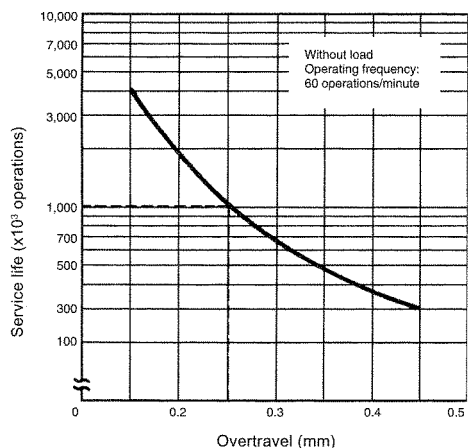

Electrical service life

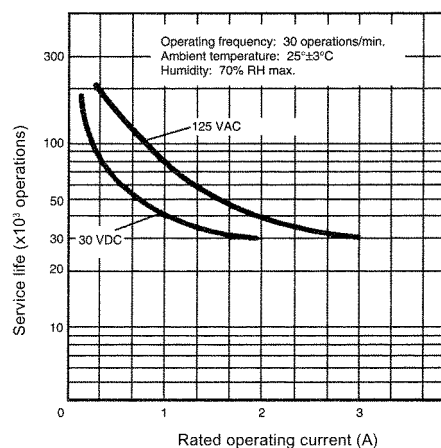

**Note: 1.** Values are for pin plunger actuator type.



# Terminals

D2F type  
PCB terminal

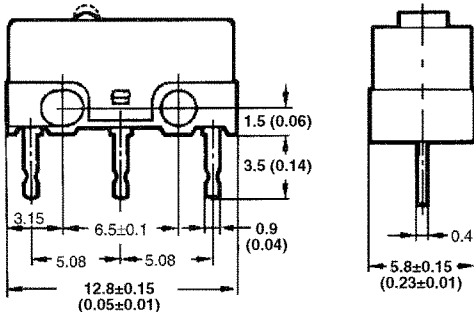

D2F-T type  
Self-supporting terminal

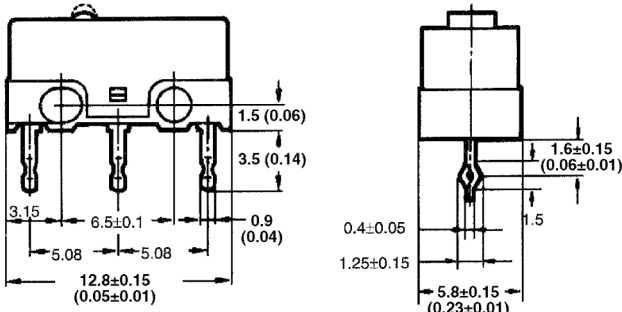

D2F-D type  
Soldered terminal

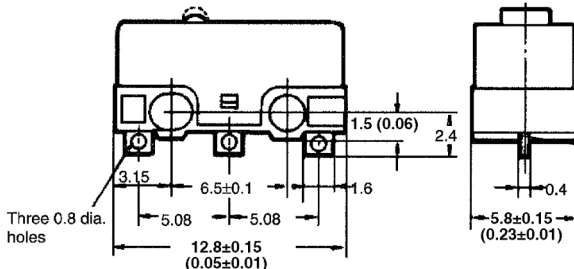

D2F-A type  
Right-angle terminal

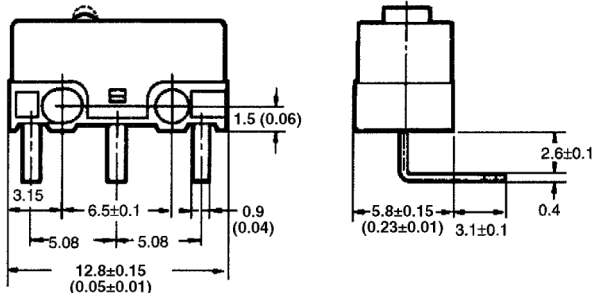

D2F-A1 type  
Left-angle terminal

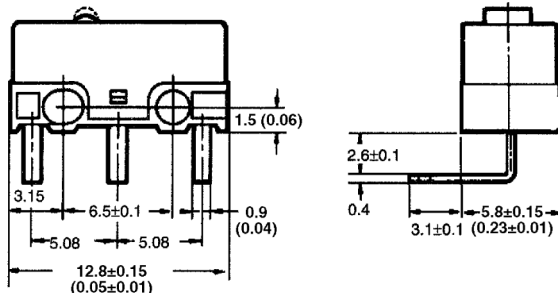

## Precautions

### ■ Mounting

Mount the D2F switch onto the PC board as shown in the following diagram, using 2-pitch (2 x 2.54 mm) terminal spacing.

### ■ PC Board Machining

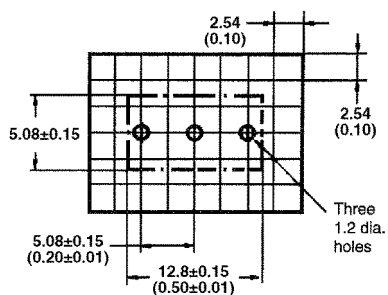

### ■ Dimensions

The use of molded components is recommended for mounting purposes.

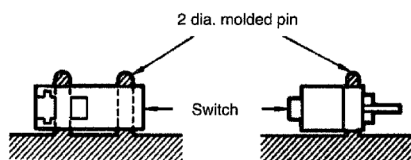

### ■ Molded Pin Mounting Diagram

When screw mounting, use M2 screws together with washers. Fasten the screws applying 0.8 to 1 kg-cm tightening torque.

### ■ Mounting Hole Machining

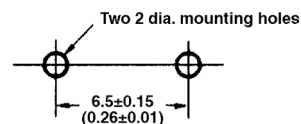

### ■ Dimensions

When soldering, use 6:4 solder and a 60 W soldering iron, and complete soldering within 3 seconds. After soldering, do not apply external force to the soldered area for about 1 minute.

Allow sufficient insulation distance between terminals and between terminals and ground.