



Designers' Choice

THREADED STANDOFFS



HEX

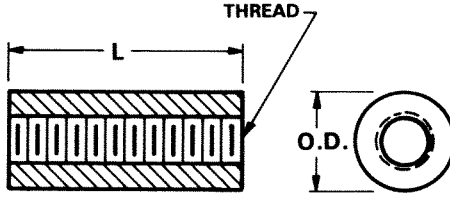

ROUND



MATERIAL

Brass: per ASTM-B16
Aluminum: QQ-A-225/3, Alloy 2011-T3

PLATING

Zinc: ASTM B633
Iridite Finish: MIL-C-5541

			ALUMINUM IRIDITE FINISH		BRASS ZINC PLATE	
			HEX	ROUND	HEX	ROUND
THREAD	O.D.	LENGTH	CAT. NO.	CAT. NO.	CAT. NO.	CAT. NO.
2-56	.156 (5/32)	3/16 (.187)	1797A	1801A	1798A	1802A
		1/4 (.250)	1797B	1801B	1798B	1802B
		5/16 (.312)	1797C	1801C	1798C	1802C
		3/8 (.375)	1797D	1801D	1798D	1802D
4-40	.187 (3/16)	1/4 (.250)	1891	2025	1450	1547
		3/8 (.375)	1892	2026	1803	1864
		1/2 (.500)	1893	2027	1656	1657
		5/8 (.625)	1894	2028	1804	1865
		3/4 (.750)	1895	2029	1656A	1657A
		7/8 (.875)	1896	2030	1805	1866
		1 (1.000)	1897	2031	1656B	1657B
4-40	.250 (1/4)	1/4 (.250)	2201	3478	1450A	1547A
		3/8 (.375)	2202	3479	1450B	1547B
		1/2 (.500)	2203	3480	1450C	1547C
		5/8 (.625)	1808	1839	1829	1867
		3/4 (.750)	2204	3481	1450D	1547D
		7/8 (.875)	1809	1846	1830	1876
		1 (1.000)	2205	3482	1450E	1547E
		1-1/2 (1.500)	2206	3483	1831	1877
		2 (2.000)	2207	3484	1832	1878
		2-1/2 (2.500)	2208	3485	1451A	1548A
6-32	.250 (1/4)	3/8 (.375)	2209	3486	1451B	1548B
		1/2 (.500)	2210	3487	1451C	1548C
		5/8 (.625)	1813	1847	1451D	1548D
		3/4 (.750)	2211	3488	1451E	1548E
		7/8 (.875)	1816	1848	1833	1879
		1 (1.000)	2212	3489	1635	1548F
		1-1/4 (1.250)	1818	1853	1636	1881
		1-1/2 (1.500)	2213	3490	1637	1882
		1-3/4 (1.750)	1819	1855	1638	1883
		2 (2.000)	2214	3491	1639	1884
		2-1/4 (2.250)	1820	1856	1642	1885
		2-1/2 (2.500)	1825	1857	1643	1886
		8-32	.250 (1/4)	1/4 (.250)	2215	3492
3/8 (.375)	2216			3493	1474B	1692B
1/2 (.500)	2217			3494	1474C	1692C
5/8 (.625)	1827			1858	1834	1887
3/4 (.750)	2218			3495	1474D	1692D
7/8 (.875)	1828			1859	1836	1888
1 (1.000)	2219			3496	1474E	1692E
1-1/2 (1.500)	2220			3497	1837	1889
2 (2.000)	2221			3498	1838	1899
8-32	.375 (3/8)	3/8 (.375)	1926A	2315A	1452A	1549A
		1/2 (.500)	1926B	2315B	1452B	1549B
		5/8 (.625)	1926C	2315C	1452C	1549C
		3/4 (.750)	1926D	2315D	1452D	1549D
		1 (1.000)	1926E	2315E	1452E	1549E

NOTE: Spacers over 1.000 long are tapped .375 deep each end.



Designers' Choice

SPACERS & STANDOFFS

ALUMINUM ECONOMY SPACERS

• PRECISION FORMED • NO BURRS

Made of flat strip aluminum and rolled on precision equipment. Assures maximum bearing surface, square ends.

Aluminum: Per 5052-H34 per QQ-A-250/8b

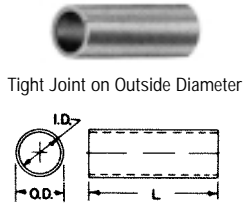

Description and Tol.

SPACER FOR	I.D. ±.005	O.D. ±.007
#4	.125	.167
#6	.151	.193
#8	.178	.232

L Length	#4 Screw CAT. NO.	#6 Screw CAT. NO.	#8 Screw CAT. NO.
.187	397	—	—
.250	398	405	412
.312	399	406	413
.375	400	407	414
.437	401	408	415
.500	402	409	416
.625	403	410	417
.750	418	425	432
.875	419	426	433
1.000	420	427	434
1.250	421	428	435
1.500	422	429	436
1.750	—	430	437
2.000	—	—	438

BLIND CAPTIVE NUTS — PRESS FIT

MOUNT CHASSIS, PANELS, HEAT SINKS, SOCKETS

MATERIAL: Molded Nylon with Brass threaded insert.

- EASY ASSEMBLY
- DAMPENS VIBRATION
- ELIMINATES INSULATING WASHER
- HI-DIELECTRIC STRENGTH

A unique reusable fastener made of NYLON which contains a threaded brass nut. Finger pressure or light tap seals it in a pre-drilled hole. The nut is drawn up causing a Nylon bulge behind the workpiece. Screw may be removed or replaced.

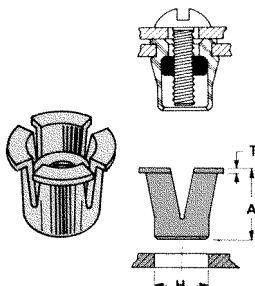

CAT. NO.	THREAD	"H" HOLE SIZE REQ/D.	IDEAL SHEET THICKNESS	A	T
4341	4-40	.250	.047	.312	.030
4342	6-32	.312	.078	.375	.030
4343	8-32	.406	.093	.500	.030

METRIC HEX THREADED STANDOFFS

A comprehensive range of precision made metric hex spacers.

MATERIAL: Brass, ASTM-B16, Nickel plated (QQ-N-290)

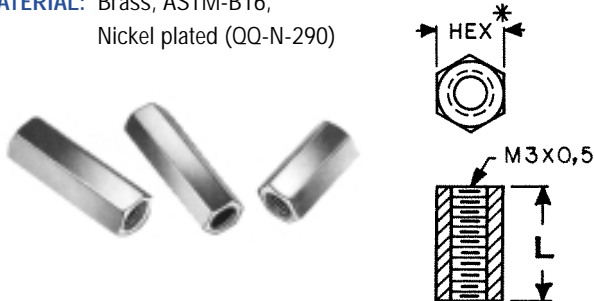

5mm HEX*	
CAT. NO.	"L"
4390	5mm
4391	10mm
4392	15mm
4393	20mm
4394	25mm

5.5mm HEX*	
CAT. NO.	"L"
4395	5mm
4396	10mm
4397	15mm
4398	20mm
4399	25mm

ROUND CLEAR SPACERS

BRASS OR ALUMINUM

MATERIALS:

Brass: ASTM-B16, Nickel plate (QQ-N-290)

Aluminum: Iridite Finish (MIL-C-5541)

L LENGTH	HOLE	BRASS	ALUMINUM
		CAT. NO.	CAT. NO.
.125	.120	1909	2036
.250	.120	1454A	3457
.375	.120	1454B	3458
.500	.120	1454C	3459
.625	.120	1919	2314
.750	.120	1454D	3460
.875	.120	1920	3402
1.000	.120	1545E	3461
1.500	.120	1924	3462
2.000	.120	1925	3463
.125	.140	1934	3403
.250	.140	1457A	3464
.375	.140	1457B	3465
.500	.140	1457C	3466
.625	.140	1935	3429
.750	.140	1957D	3467
.875	.140	1936	3438
1.000	.140	1457E	3468
1.500	.140	1937	3469
2.000	.140	1938	3470
.125	.171	1942	4258
.250	.171	1480	3471
.375	.171	1481	3472
.500	.171	1482	3473
.625	.171	2032	4259
.750	.171	1483	3474
.875	.171	2033	4260
1.000	.171	1484	3475
1.500	.171	2034	3476
2.000	.171	2035	3477

CLEARANCE HOLE:

- .120 for #4 screw
- .140 for #6 screw
- .171 for #8 screw

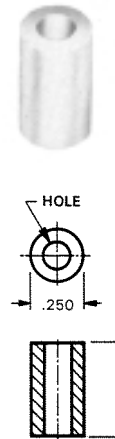

ROUND SWAGE CLEAR SPACERS

MATERIAL: Brass, ASTM-B16, Nickel plate (QQ-N-290)

CLEARANCE HOLE:

- .120 for #4 screw
- .140 for #6 screw

CAT. NO.	H HEIGHT	FOR PANEL THICKNESS	C HOLE	L
5060-2	.250	1/16	.120	.109
5060-3	.250	3/32	.120	.141
5061-2	.375	1/16	.120	.109
5061-3	.375	3/32	.120	.141
5062-2	.500	1/16	.120	.109
5062-3	.500	3/32	.120	.141
5063-2	.250	1/16	.140	.109
5063-3	.250	3/32	.140	.141
5064-2	.375	1/16	.140	.109
5064-3	.375	3/32	.140	.141
5065-2	.500	1/16	.140	.109
5065-3	.500	3/32	.140	.141

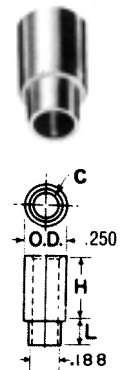

HEX STAINLESS THREADED STANDOFFS

MATERIAL: Stainless Steel per ASTM-A581/A582, Class 303

• Corrosion Resistant

L Length Inches	4-40 Thread CAT. NO.	6-32 Thread CAT. NO.	8-32 Thread CAT. NO.
1/4 (.250)	1921	1922	1923
3/8 (.375)	1921A	1922A	1923A
1/2 (.500)	1921B	1922B	1923B
3/4 (.750)	1921C	1922C	1923C
1 (1.000)	1921D	1922D	1923D
1 1/2 (1.500)	1921E	1922E	1923E
2 (2.000)	1921F	1922F	1923F

- 4-40 thread on 1/2" and over tapped 1/4" each end
- 6-32 & 8-32 thread on 1" and over tapped 3/8" each end

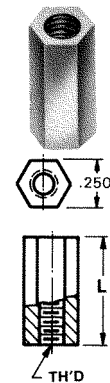



Designers' Choice

INSULATED SPACERS/STANDOFFS

CERAMIC STANDOFFS

- Ideal for very high temperature conditions
- Commercial and military types available
- Special sizes available upon request
- Exceptional strength in compression and tension
- Withstands very high voltage without flashover.
- Military types meet MIL-1-010, NL# clearly marked

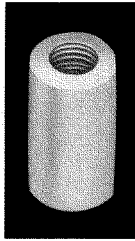
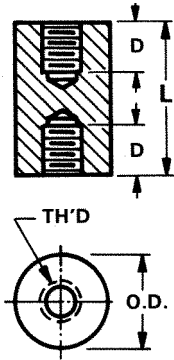

COMMERCIAL

CAT. NO.	LENGTH	O.D.	T THREAD	D(2) DEPTH
7710	.250	.250	6-32	THRU
7711	.500	.250	6-32	.156
7712	.375	.375	6-32	.156
7713	.500	.375	6-32	.187
7714	.500	.500	6-32	.140
7715	.750	.500	6-32	.250
7716	1.000	.500	6-32	.375
7717	1.500	.500	6-32	.562
7718	2.500	.500	6-32	.500
7719	2.500	.750	1/4-20	.750
7720	4.000	.750	1/4-20	.750

MILITARY

CAT. NO.	LENGTH	O.D.	T THREAD	D(2) DEPTH	NL #
7661	.500	.375	6-32	.156	NL523W01-004
7662	.625	.375	6-32	.250	NL523W01-005
7663	.625	.500	8-32	.187	NL523W02-005
7664	.750	.375	6-32	.250	NL523W01-006
7665	.750	.500	8-32	.250	NL523W02-006
7666	1.000	.375	10-32	.375	NL523W01-008
7667	1.000	.500	8-32	.375	NL523W02-008
7668	1.000	.750	10-32	.375	NL523W03-008
7669	1.250	.375	6-32	.375	NL523W01-010
7670	1.250	.500	8-32	.375	NL523W02-010
7671	1.250	1.000	1/4-20	.437	NL523W04-010
7672	1.500	.375	6-32	.375	NL523W01-012
7673	1.500	.500	8-32	.375	NL523W02-012
7674	1.500	.750	10-32	.375	NL523W03-012
7675	1.500	1.000	1/4-20	.500	NL523W04-012
7676	2.000	.375	6-32	.375	NL523W01-016
7677	2.000	.500	8-32	.375	NL523W02-016
7678	2.000	.750	10-32	.375	NL523W03-016

MATERIAL: Grade L5 Ceramic

PHENOLIC SPACERS/STANDOFFS

- RESISTS ABRASIONS & CHEMICALS • EXCELLENT DIELECTRIC STRENGTH
- LOW MOISTURE ABSORPTION • GOOD MECHANICAL STRENGTH

MATERIAL: PBE Grade Natural Color Phenolic

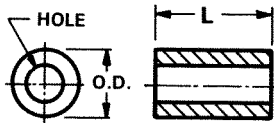
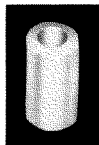

CLEAR HOLE SPACERS

"L" Length Inches	.250 O.D. (1/4)			.312 O.D.
	#4 Screw .120 Hole CAT. NO.	#6 Screw .140 Hole CAT. NO.	#8 Screw .171 Hole CAT. NO.	#10 Screw .200 Hole CAT. NO.
1/4 (.250)	360	367	1490	453
3/8 (.375)	361	368	1491	454
1/2 (.500)	362	369	1492	455
3/4 (.750)	363	370	1493	456
1 (1.000)	364	371	1494	457
1 1/2 (1.500)	365	372	374	458
2 (2.000)	366	373	375	459

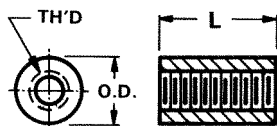

THREADED STANDOFFS

"L" Length Inches	.250 O.D. (1/4)			.312 O.D.	
	4-40 Th'd CAT. NO.	6-32 Th'd CAT. NO.	8-32 Th'd CAT. NO.	8-32 CAT. NO.	10-32 CAT. NO.
1/4 (.250)	376	383	390	460	467
3/8 (.375)	377	384	391	461	468
1/2 (.500)	378	385	392	462	469
3/4 (.750)	379	386	393	463	470
1 (1.000)	380	387	394	464	471
1 1/2 (1.500)	381	388	395	465	472
2 (2.000)	382	389	396	466	473

NOTE: 1 1/2" and 2" spacers are tapped 3/8" deep each end.

NYLON SPACERS/STANDOFFS

Economical for terminal or printed circuit board supports.

ROUND THRU-HOLE SPACERS

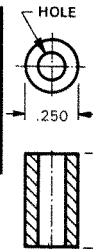
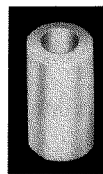

"L" Length Inches	#4 Screw .120 Hole CAT. NO.	#6 Screw .140 Hole CAT. NO.	#8 Screw .171 Hole CAT. NO.
1/8 (.125)	875	883	891
1/4 (.250)	876	884	892
3/8 (.375)	877	885	893
1/2 (.500)	878	886	894
5/8 (.625)	879	887	895
3/4 (.750)	880	888	896
7/8 (.875)	881	889	897
1 (1.000)	882	890	898

MATERIAL: Nylon 6/6

HEX THREADED STANDOFFS

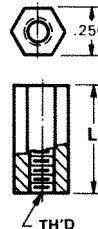
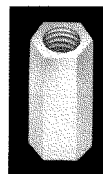

"L" Length Inches	4-40 Thread CAT. NO.	6-32 Thread CAT. NO.	8-32 Thread CAT. NO.
1/4 (.250)	1902A	1903A	1904A
3/8 (.375)	1902B	1903B	1904B
1/2 (.500)	1902C	1903C	1904C
5/8 (.625)	1902F	1903F	1904F
3/4 (.750)	1902D	1903D	1904D
7/8 (.875)	1902G	1903G	1904G
1 (1.000)	1902E	1903E	1904E

MATERIAL: Nylon 6/6

FLAME RETARDANT HEX THREADED STANDOFFS

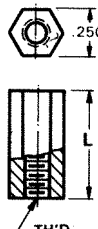
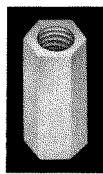

"L" Length Inches	4-40 Thread CAT. NO.	6-32 Thread CAT. NO.	8-32 Thread CAT. NO.
1/4 (.250)	8440A	8441A	8442A
3/8 (.375)	8440B	8441B	8442B
1/2 (.500)	8440C	8441C	8442C
5/8 (.625)	8440D	8441D	8442D
3/4 (.750)	8440E	8441E	8442E
7/8 (.875)	8440F	8441F	8442F
1 (1.000)	8440G	8441G	8442G

MATERIAL: Nylon 6/6

CUSTOM DESIGN WORKSHEET

Designers' Choice



THREADED STANDOFFS

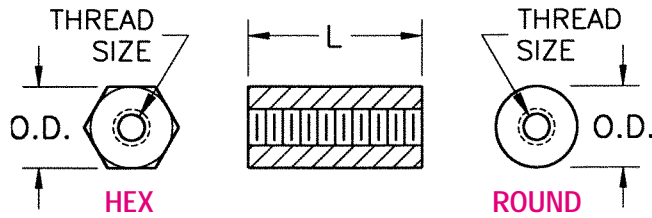

HEX O.D.	L	THREAD	ROUND O.D.

MATERIAL:

FINISH:

Quantities to Quote:

CLEAR SPACERS

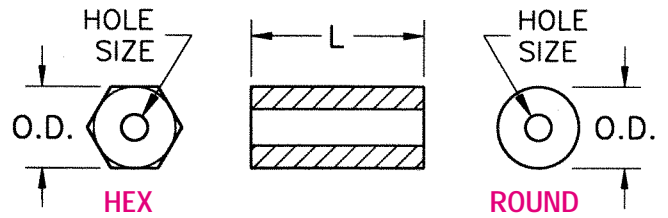

HEX O.D.	L	THREAD	ROUND O.D.

MATERIAL:

FINISH:

Quantities to Quote:

MALE/FEMALE STANDOFFS

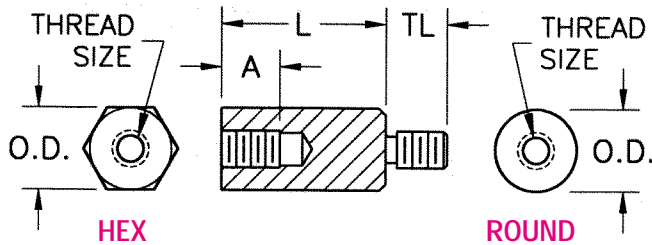

HEX O.D.	L	A	TL	THREAD	ROUND O.D.

MATERIAL:

FINISH:

Quantities to Quote:

ENGINEERING DATA

Clearance Hole	
For Screw Sizes	Hole Sizes
#2	.093 (2.4)
#4	.119 (3.0)
M3	.125 (3.2)
#6/M3.5	.145 (3.7)
#8/M4	.171 (4.4)
#10	.197 (5.0)

Material Code	MATERIALS
AL	Aluminum - QQ-Q-225/3
BR	Brass - ASTM-B16
NV0	Nylon 6/6 - UL Rated 94V-0
NV2	Nylon 6/6 - UL Rated 94V-2
PH	Phenolic - PBE Natural Color
SS	Stainless Steel - ASTM-A581/A582
S	Steel - ASTM-108
O	Other - Specify

Thread Depth Reference		
Thread	A	TL
2-56	.187 (4.8)	.156 (4.0)
4-40/M3	.250 (6.3)	.187 (4.8)
6-32/M3.5	.375 (9.5)	.250 (6.3)
8-32/M4	.437 (11.1)	.375 (9.5)
10-32	.500 (12.7)	.375 (9.5)

Finish Code	FINISHES
AB	Anodize (Black) - MIL-A-8625
AC	Anodize (Clear) - MIL-A-8625
IC	Iridite (Clear) - MIL-C-5541
IG	Iridite (Gold) - MIL-C-5541
N	Nickel - QQ-N-290
P	Passivate - MIL-S-5002
T	Tin - MIL-T-10728
TLD	Tin-Lead - MIL-S-5002
ZC	Zinc (Clear) - ASTM-B633
ZG	Zinc (Gold) - ASTM-B633
O	Other - Specify

If you have any questions, please contact our application engineers

For prompt quotations fax, mail or e-mail a copy of this worksheet.

Name: _____

Company: _____

Address: _____

Phone: _____ Fax: _____

e-mail: _____

CREATE YOUR OWN CONFIGURATION

MATERIAL:

FINISH:

QUANTITIES TO QUOTE: