

PRODUCT NUMBER
SEE TABLE

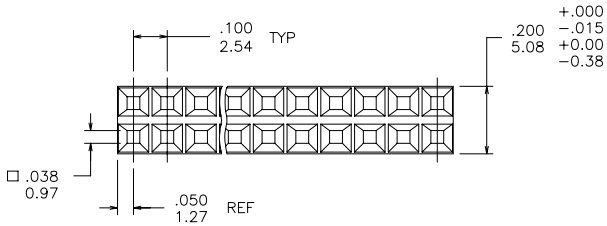
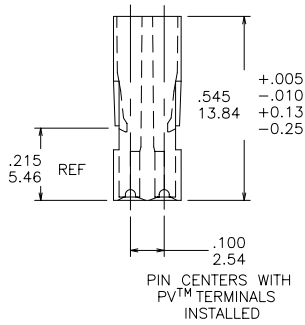
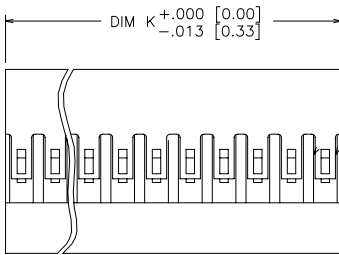

NOTES

- ① MOLDING MAT'L: MODIFIED POLYPHENYLENE ETHER. COLOR: BLACK, MEETING UL 94V-0.
2. PIN LENGTH TO BE .210/5.33 MIN. RECOMMENDED PIN LENGTH IS .225±.015/5.72±0.38.
3. FOR TERMINAL APPLICATION SEE TA-531.
4. TERMINALS MUST BE CRIMPED PROPERLY FOR SATISFACTORY LATCHING. SEE TA-75 FOR CRIMPING INSTRUCTIONS. PRODUCT SPECIFICATION: BUS-12-067
5. THIS HOUSING IS INTENDED FOR USE WITH MINI PV™ TERMINAL WITH 22-36 GAUGE WIRE.
- ⑥ ALL MARKINGS EXCEPT LOGO USE 6 POINT TYPE (APPROX .06/1.52 HIGH) AND WHITE INK (MARKEM #8829 OR EQUIV.) WHEN MARKING CAVITIES. NUMERALS OR LETTERS ARE TO BE CENTERED ON RESPECTIVE CAVITIES, UNLESS OTHERWISE NOTED.
- ⑦ LOGO TO BE POSITIONED IN THIS AREA SO THAT IT IS READ FROM THE SAME EDGE OF THE CONNECTOR AS THE OTHER MARKINGS.
- ⑧ ALL MARKINGS FOR MILITARY PART NUMBERS ARE TO BE PER MIL-STD-1285 SEE TABULATION.
- ⑨ PLACE DESC P/N AND CAGE NO. ON PACKAGING LABEL. PRODUCT LENGTH IS TOO SMALL TO MARK PRINT.
10. PRODUCT MEETS EUROPEAN UNION DIRECTIVES AND OTHER COUNTRY REGULATIONS AS DESCRIBED IN GS-22-008.
11. THE PRODUCT IS NOT INTENDED TO BE EXPOSED TO MANUFACTURING SOLDER PROCESS.
- ⑫ EUROPEAN CUSTOMERS SHOULD ORDER PART NUMBERS WITH AN 'E' SUFFIX AS SHOWN IN TABLE TO CONTINUE TO BE SUPPLIED BY THE EUROPEAN PLANT. SEE DRAWING 65043EUR.

mat'l code		surface		tolerance		projection		product family	
SEE NOTE 1		ASME Y14.5 ✓		ASME Y14.5		INCH/MM		PV HOUSINGS	
lfr	ec'n no	dr	date	tolerances unless otherwise specified		INCH/MM		title	
BF	v07-0483	HTB	2007-07-24	angles	XXX+01/XX-3	scale 2.5:1		MINI LATCH HOUSING	
BG	v08-0022	HTB	2008-01-15	0°±2'	XXX+005/XXX+13			DOUBLE ROW .100 [2.54] CC	
					XXXX+0020/XXX+051			dwg no 65043 sheet 1 of 11 size A4	
BB	v05-0712	DAI	2005-07-27	dr	M. CLOUSER	FCJ		type Product Customer Drawing	
BC	v06-0407	HTB	2006-04-27	engr	C. TREXLER				
BD	v06-0549	HTB	2006-06-12	chr	C. TREXLER				
BE	v06-0886	HTB	2006-08-31	appd	C. TREXLER				
sheet	revision	BG	BG	BG	BG	BG	BG	BG	BG
index	sheet	1	2	3	4	5	6	7	8

<p>PRODUCT NUMBER SEE TABLE</p> <p>MARK POSITION ONE AND CUST. NAME AS SHOWN.</p> <p>STYLE A</p> <p>MARK LOGO AND POSITIONS AS SHOWN</p> <p>NOTE 7</p> <p>STYLE B</p> <p>MARK ARROW IN WHITE AS SHOWN ON SURFACE OPPOSITE GATE.</p> <p>STYLE C</p>	<p>MARK POSITION NUMBERS AS SHOWN TO LENGTH OF PART.</p> <p>SECOND POSITION</p> <p>STYLE D</p> <p>MARK POSITIONS AS SHOWN.</p> <p>STYLE E</p> <p>MARK CUSTOMERS P/N AND REVISION LEVEL IN AREA SHOWN.</p> <p>STYLE F</p>	<p>MARK TOP, CO. LOGO, CUST P/N REV LEVEL, DATE OF MFG, SECOND & NEXT TO LAST POS ON BOTH SIDES IN WHITE AS SHOWN.</p> <p>COMPANY PART NO.</p> <p>NOTE 7</p> <p>CUST PART NO.</p> <p>DATE OF MFG</p> <p>REVISION LEVEL</p> <p>STYLE G</p> <p>STYLE H</p> <p>MARK TOP, CO. LOGO, CUST P/N REV LEVEL, DATE OF MFG, SECOND & NEXT TO LAST POS ON BOTH SIDES IN WHITE AS SHOWN.</p> <p>COMPANY PART NO.</p> <p>NOTE 7</p> <p>CUST PART NO.</p> <p>DATE OF MFG</p> <p>REVISION LEVEL</p> <p>STYLE I</p> <p>STYLE J</p>	<p>MARK CAVITIES AS SHOWN.</p> <p>ELEVENTH POS</p> <p>SEC POS</p> <p>STYLE K</p> <p>MARK SECOND CAVITY AS SHOWN.</p> <p>STYLE L</p>
--	--	---	---

mat'l. code SEE NOTE 1	surface ASME Y14.5 ✓	tolerance ASME Y14.5	projection 	product family PV HOUSINGS
l/r ecn no	dr	date	tolerances unless otherwise specified XX±01/XX±3 XXX±005/XXX±8 0'±2'	title MINI LATCH HOUSING DOUBLE ROW .100 [2.54] CC
BG	angles	fin	INCH/MM	dwg no 65043
	0'±2'	XXXXX0020/XXX±051	scale 1:1	sheet 2 of 11 size A4
	dr	M. CLOUSER 1990-01-31		type Product Customer Drawing
	engr	C. TREXLER 1990-01-31		
	chr	C. TREXLER 1990-01-31		
	appd	C. TREXLER 1990-01-31		
sheet index	revision sheet			

<p>PRODUCT NUMBER SEE TABLE</p>		<p>MARK CHARACTERS AS SHOWN IN WHITE.(ONE SIDE ONLY)</p> <p>STYLE Q</p>	<p>MARK CHARACTERS ONE SIDE ONLY.</p> <p>STYLE U</p>	<p>MARK POSITION IDENTIFICATION AS SHOWN.</p> <p>NOTE 7</p> <p>STYLE Y</p> <p>MARK POSITIONS 1, 2 AND 3 ONLY SEE NOTE 6</p> <p>STYLE Z</p>
<p>MARK CO. LOGO, CUST P/N AND FIRST & LAST POS PLUS EVERY FOURTH POS IN WHITE AS SHOWN (ONE SIDE ONLY)</p> <p>NOTE: HOUSING WITH 16 POS OR LESS WILL NOT HAVE CO. LOGO INCLUDED.</p> <p>NOTE 7</p> <p>STYLE M</p>	<p>CO. LOGO AND P/N MARKED AS SHOWN. NO CO. P/N ON HOUSING LESS THAN 2 X 8.</p> <p>NOTE 7</p> <p>STYLE R</p>	<p>MARK CHARACTERS ONE POSITION AND SIDE A AND B AS SHOWN.</p> <p>STYLE V</p>		
<p>MARK CAV IDENTIFICATION APPROX AS SHOWN.(ONE SIDE ONLY)</p> <p>STYLE N</p>	<p>MARK CHARACTERS IN WHITE AS SHOWN.</p> <p>STYLE S</p>	<p>MARK POS 1 & 26 CO. LOGO & P/N AS SHOWN SEE NOTE 6.</p> <p>NOTE 7</p> <p>STYLE W</p>		
<p>MARK CAVITY AS SHOWN WITH ARROW.</p> <p>STYLE O</p>	<p>MARK CHARACTERS IN WHITE AS SHOWN.</p> <p>STYLE T</p>			
<p>MARK CHARACTERS AS SHOWN IN WHITE.(ONE SIDE ONLY)</p> <p>SECOND POSITION</p> <p>STYLE P</p>				

mat'l code	SEE NOTE 1	surface	tolerance	projection	product family
ltr	ecrn no	ASME Y14.5 ✓	ASME Y14.5		PV HOUSINGS
dr	date	tolerances unless otherwise specified		INCH/MM	title
BG		angles	XX±01/XX±3	scale 1:1	MINI LATCH HOUSING
		0'±2'	XXX±005/XXX±13		DOUBLE ROW .100 [2.54] CC
			XXXX±0020/XXX±051		dwg no
		dr	M. CLOUSER 1990-01-31		65043
		engr	C. TREXLER 1990-01-31		sheet 3 of 11
		chr	C. TREXLER 1990-01-31		size A4
		appd	C. TREXLER 1990-01-31		type
sheet	revision				Product Customer Drawing
index	sheet				

<p>PRODUCT NUMBER SEE TABLE</p> <p>NUMBER TO BE LOCATED IN CENTER OF RESPECTIVE POSITION</p> <p>STYLE AA</p>	<p>MARK FIRST AND LAST POSITION WITH APPROPRIATE NO. ALL EVEN # POSITIONS ON SAME SIDE OF HOUSING</p> <p>STYLE AD</p>	<p>NUMBER EVERY OTHER POSITION AND SIDE A AND B AS SHOWN. MARK CHARACTERS IN WHITE.</p> <p>STYLE AG</p>	<p>MARK "THIS SIDE UP" AND POSITION NUMBERS 13 & 24 AS SHOWN IN .060/1.52 HIGH CHARACTERS.</p> <p>STYLE AK</p>
<p>MARK ENTIRE SURFACE WHITE</p> <p>STYLE AB</p>	<p>MARK FIRST AND LAST POSITION WITH APPROPRIATE NO. BOTH SIDES ALL EVEN # POSITIONS ON SAME SIDE OF HOUSING</p> <p>STYLE AE</p>	<p>MARK NUMBERS IN WHITE.</p> <p>STYLE AH</p>	<p>MARK FIRST AND LAST POSITION WITH APPROPRIATE NO. ON ONE SIDE. ALSO PRINT "THIS SIDE UP-1" AS SHOWN.</p> <p>STYLE AL</p>
<p>IDENTIFY POSITIONS 1, 6, 13 WITH WHITE CHARACTERS LOCATED AS SHOWN.</p> <p>STYLE AC</p>	<p>MARK HOUSING (ONE SIDE ONLY) EVERY SECOND POSITION WITH APPROPRIATE NO. ODD NUMBERS TO LENGTH OF PART DO NOT MARK END POSITIONS</p> <p>STYLE AF</p>	<p>MARK FIRST AND LAST POSITION BOTH SIDES AS SHOWN. TO LENGTH OF PART.</p> <p>STYLE AJ</p>	

mat'l. code	SEE NOTE 1	surface	tolerance	projection	product family
l/r	ec'n no	dr	date	tolerances unless otherwise specified	title
BG				ASME Y14.5 ✓ ASME Y14.5	PV HOUSINGS
				angles	MINI LATCH HOUSING
				0°±2'	DOUBLE ROW .100 [2.54] CC
				dr M. CLOUSER 1990-01-31	dwg no 65043
				engr C. TREXLER 1990-01-31	sheet 4 of 11 size A4
				chr C. TREXLER 1990-01-31	type Product Customer Drawing
				appd C. TREXLER 1990-01-31	
sheet index	revision sheet				

PRODUCT NUMBER
SEE TABLE

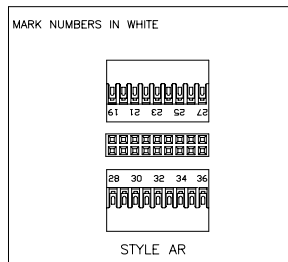
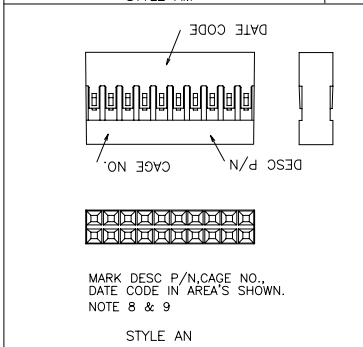
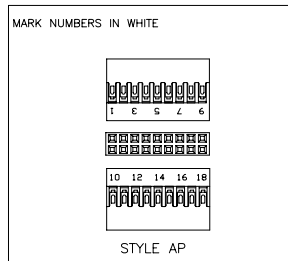
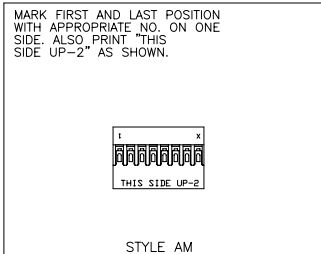

mat'l. code		SEE NOTE 1		surface	tolerance	projection	product family
ltr	ecn no	dr	date	ASME Y14.5 ✓	ASME Y14.5		PV HOUSINGS
BG				tolerances unless otherwise specified		INCH/MM	title
				angles	XXX+01/XX-3	scale 1:1	MINI LATCH HOUSING
				0°±2'	XXX+005/XXX+13		DOUBLE ROW .100 [2.54] CC
				dr	M. CLOUSER 1990-01-31		dwg no
				engr	C. TREXLER 1990-01-31		sheet 5 of 11
				chr	C. TREXLER 1990-01-31		size
				appd	C. TREXLER 1990-01-31		A4
sheet index	revision sheet						type Product Customer Drawing



PRODUCT NO.	NO OF POS	DIM K	EUROPEAN VERSION-NOTE 12
65043-001LF	2 X 36	3.600/91.44	65043-001ELF
65043-002LF	2 X 35	3.500/88.90	65043-002ELF
65043-003LF	2 X 34	3.400/86.36	65043-003ELF
65043-004LF	2 X 33	3.300/83.82	65043-004ELF
65043-005LF	2 X 32	3.200/81.28	65043-005ELF
65043-006LF	2 X 31	3.100/78.74	65043-006ELF
65043-007LF	2 X 30	3.000/76.20	65043-007ELF
65043-008LF	2 X 29	2.900/73.66	65043-008ELF
65043-009LF	2 X 28	2.800/71.12	65043-009ELF
65043-010LF	2 X 27	2.700/68.58	65043-010ELF
65043-011LF	2 X 26	2.600/66.04	65043-011ELF
65043-012LF	2 X 25	2.500/63.50	65043-012ELF
65043-013LF	2 X 24	2.400/60.96	65043-013ELF
65043-014LF	2 X 23	2.300/58.24	65043-014ELF
65043-015LF	2 X 22	2.200/55.88	65043-015ELF
65043-016LF	2 X 21	2.100/53.34	65043-016ELF
65043-017LF	2 X 20	2.000/50.80	65043-017ELF
65043-018LF	2 X 19	1.900/48.26	65043-018ELF
65043-019LF	2 X 18	1.800/45.72	65043-019ELF
65043-020LF	2 X 17	1.700/43.18	65043-020ELF
65043-021LF	2 X 16	1.600/40.64	65043-021ELF
65043-022LF	2 X 15	1.500/38.10	65043-022ELF
65043-023LF	2 X 14	1.400/35.56	65043-023ELF
65043-024LF	2 X 13	1.300/33.02	65043-024ELF
65043-025LF	2 X 12	1.200/30.48	65043-025ELF
65043-026LF	2 X 11	1.100/27.94	65043-026ELF
65043-027LF	2 X 10	1.000/25.40	65043-027ELF
65043-028LF	2 X 9	.900/22.86	65043-028ELF
65043-029LF	2 X 8	.800/20.32	65043-029ELF
65043-030LF	2 X 7	.700/17.78	65043-030ELF
65043-031LF	2 X 6	.600/15.24	65043-031ELF
65043-032LF	2 X 5	.500/12.70	65043-032ELF
65043-033LF	2 X 4	.400/10.16	65043-033ELF
65043-034LF	2 X 3	.300/7.62	65043-034ELF
65043-035LF	2 X 2	.200/5.08	65043-035ELF

mat'l. code		SEE NOTE 1		surface ASME Y14.5 ✓ / tolerance ASME Y14.5		projection		product family PV HOUSINGS	
ltr	ecrn no	dr	date	tolerances unless otherwise specified		INCH/MM		title	
bc				angles	XXX+01/XX+3	scale 1:1		MINI LATCH HOUSING	
				0°±2'	XXX+005/XXX+13			DOUBLE ROW .100 [2.54] CC	
				dr	M. CLOUSER 1990-01-31			dwg no 65043 sheet 6 of 11 size A4	
				engr	C. TREXLER 1990-01-31			type Product Customer Drawing	
				chr	C. TREXLER 1990-01-31				
				appd	C. TREXLER 1990-01-31				
sheet index	revision sheet								



MILITARY PRODUCT NO.	MADE FROM	MARKING STYLE	DESC P/N	CAGE NO.	
65043-001-MIL	65043-001	AN	86038-72	22526	OBSOLETE
-002	-002		70		OBSOLETE
-003	-003		68		OBSOLETE
-004	-004		66		OBSOLETE
-005	-005		64		OBSOLETE
-006	-006		62		OBSOLETE
-007	-007		60		OBSOLETE
-008	-008		58		OBSOLETE
-009	-009		56		OBSOLETE
-010	-010		54		OBSOLETE
-011	-011		52		OBSOLETE
-012	-012		50		OBSOLETE
-013	-013		48		OBSOLETE
-014	-014		46		OBSOLETE
-015	-015		44		OBSOLETE
-016	-016		42		OBSOLETE
-017	-017		40		OBSOLETE
-018	-018		38		OBSOLETE
-019	-019		36		OBSOLETE
-020	-020		34		OBSOLETE
-021	-021		32		OBSOLETE
-022	-022		30		OBSOLETE
-023	-023		28		OBSOLETE
-024	-024		26		OBSOLETE
-025	-025		24		OBSOLETE
-026	-026		22		OBSOLETE
-027	-027		20		OBSOLETE
-028	-028		18		OBSOLETE
-029	-029		16		OBSOLETE
-030	-030		14		OBSOLETE
-031	-031		12		OBSOLETE
-032	-032		10		OBSOLETE
-033	-033		08		OBSOLETE
-034	-034		06		OBSOLETE
65043-035-MIL	65043-035	AN	86038-04	22526	SEE NOTE 9 OBSOLETE

mat'l. code	SEE NOTE 1	surface	tolerance	projection	product family
ltr	ecn no	dr	date	ASME Y14.5 ✓ ASME Y14.5	PV HOUSINGS
bg				tolerances unless otherwise specified	title
				angles	MINI LATCH HOUSING
				0°±2'	DOUBLE ROW .100 [2.54] CC
				dr M. CLOUSER 1990-01-31	dwg no
				engr C. TREXLER 1990-01-31	sheet 7 of 11 size
				chr C. TREXLER 1990-01-31	65043 A4
				appd C. TREXLER 1990-01-31	type
sheet index	revision sheet				Product Customer Drawing



PRODUCT NO.	NO OF POS	DIM K	MARKINGS STYLE	CUSTOMER RESTRICTED
65043-037LF	2 X 13	1.300/33.02	A	*
65043-038LF	2 X 22	2.200/55.88	B	
65043-039LF	2 X 12	1.200/30.48	C	
65043-040LF	2 X 16	1.600/40.64	C	
65043-041LF	2 X 20	2.000/50.80	C	
65043-042LF	2 X 24	2.400/60.96	C	
65043-043LF	2 X 4	.400/10.16	C	
65043-044LF	2 X 8	.800/20.32	C	
65043-045LF	2 X 30	3.000/76.20	D	
65043-046LF	2 X 10	1.000/25.40	E	
65043-047LF	2 X 13	1.300/33.02	E	
65043-048LF	2 X 20	2.000/50.80	F	*
65043-049LF	2 X 10	1.000/25.40	F	*
65043-050LF	2 X 15	1.500/38.10	C	
65043-051LF	2 X 2	.200/5.08	C	*
65043-052LF	2 X 13	1.300/33.02	K	*
65043-053LF	2 X 3	.300/7.62	L	*
65043-054LF	2 X 15	1.500/38.10	J	*
65043-055LF	2 X 22	2.200/55.88	G	*
65043-056LF	2 X 20	2.000/50.80	H	*
65043-057LF	2 X 20	2.000/50.80	E	
65043-058LF	2 X 5	.500/12.70	M	*
65043-059LF	2 X 6	.600/15.24	M	*
65043-060LF	2 X 10	1.000/25.40	M	*
65043-061LF	2 X 13	1.300/33.02	M	*
65043-062LF	2 X 16	1.600/40.64	M	*
65043-063LF	2 X 17	1.700/43.18	M	*
65043-064LF	2 X 20	2.000/50.80	M	*
65043-065LF	2 X 4	.400/10.16	N	
65043-066LF	2 X 14	1.400/35.56	E	
65043-067LF	2 X 13	1.300/33.02	G	*
65043-068LF	2 X 17	1.700/43.18	G	*
65043-069LF	2 X 20	2.000/50.80	G	*
65043-070LF	2 X 12	1.200/30.48	O	
65043-071LF	2 X 19	1.900/48.26	O	

mat'l code	SEE NOTE 1	surface	tolerance	projection	product family
tr	ecm no	dr	date	ASME Y14.5 ✓ ASME Y14.5	PV HOUSINGS
BC				tolerances unless otherwise specified	title
				angles	MINI LATCH HOUSING
				0°±2'	DOUBLE ROW .100 [2.54] CC
				dr	M. CLOUSER 1990-01-31
				engr	C. TREXLER 1990-01-31
				chr	C. TREXLER 1990-01-31
				appd	C. TREXLER 1990-01-31
sheet index	revision sheet				type Product Customer Drawing



PRODUCT NO.	NO OF POS	DIM K	SPECIAL MARKINGS STYLE	CUSTOMER RESTRICTED
65043-072LF	2 X 22	2.200/55.88	O	
65043-073LF	2 X 27	2.700/68.58	P	
65043-074LF	2 X 10	1.000/25.40	Q	
65043-075LF	2 X 10	1.000/25.40	O	
65043-076LF	2 X 10	1.000/25.40	M	
65043-077LF	2 X 22	2.200/55.88	R	
65043-078LF	2 X 20	2.000/50.80	R	
65043-079LF	2 X 6	.600/15.24	R	
65043-080LF	2 X 8	.800/20.32	R	
65043-081LF	2 X 7	.700/17.78	R	
65043-082LF	2 X 11	1.100/27.94	R	
65043-083LF	2 X 12	1.200/30.48	R	
65043-084LF	2 X 20	2.000/50.80	O	
65043-085LF	2 X 10	1.000/25.40	R	
65043-086LF	2 X 19	1.900/48.26	C	
65043-087LF	2 X 10	1.000/25.40	C	
65043-088LF	2 X 5	.500/12.70	C	
65043-089LF	2 X 3	.300/7.62	N	
65043-090LF	2 X 9	.900/22.86	O	
65043-091LF	2 X 13	1.300/33.02	O	
65043-092LF	2 X 13	1.300/33.02	S	
65043-093LF	2 X 3	.300/7.62	T	
65043-094LF	2 X 11	1.100/27.94	U	
65043-095LF	2 X 13	1.300/33.02	V	
65043-096LF	2 X 13	1.300/33.02	W	
65043-097LF	2 X 13	1.300/33.02	M	
65043-098LF	2 X 25	2.500/63.50	M	*
65043-099LF	2 X 4	.400/10.16	O	
65043-100LF	2 X 13	1.300/33.02	Y	
65043-101LF	2 X 7	.700/17.78	Z	
65043-102LF	2 X 22	2.200/55.88	Z	
65043-103LF	2 X 26	2.600/66.04	Z	
65043-104LF	2 X 32	3.200/81.28	Z	
65043-105LF	2 X 10	1.000/25.40	Z	
65043-106LF	2 X 8	.800/20.32	Z	

mat'l code	SEE NOTE 1	surface	tolerance	projection	product family
tr	ecm no	dr	date	ASME Y14.5 ✓ ASME Y14.5	PV HOUSINGS
BC				tolerances unless otherwise specified	title
				angles	MINI LATCH HOUSING
				0°±2'	DOUBLE ROW .100 [2.54] CC
				dr	dwg no
				engr	sheet 9 of 11
				chr	size A4
				appd	65043
sheet index	revision sheet				type Product Customer Drawing



PRODUCT NO	NO OF POS	DIM K	MARKINGS STYLE	CUSTOMER RESTRICTED
65043-107LF	2 X 5	.500/12.70	Z	
65043-108LF	2 X 15	1.500/38.10	Z	
65043-109LF	2 X 30	3.000/76.20	Z	
65043-110LF	2 X 13	1.300/33.02	Z	
65043-111LF	2 X 2	.200/5.08	AA	
65043-112LF	2 X 5	.500/12.70	AA	
65043-113LF	2 X 6	.600/15.24	AA	
65043-114LF	2 X 7	.700/17.78	AA	
65043-115LF	2 X 8	.800/20.32	AA	
65043-116LF	2 X 7	.700/17.78	AB	*
65043-117LF	2 X 7	.700/17.78	O	
65043-118LF	2 X 13	1.300/33.02	C	
65043-119LF	2 X 13	1.300/33.02	AC	
65043-120LF	2 X 2	.200/5.08	Z	
65043-121LF	2 X 4	.400/10.16	Z	
65043-122LF	2 X 17	1.700/43.18	Z	
65043-123LF	2 X 20	2.000/50.80	Z	
65043-124LF	2 X 8	.800/20.32	O	
65043-125LF	2 X 15	1.500/38.10	D	
65043-126LF	2 X 30	3.000/76.20	Y	
65043-127LF	2 X 15	1.500/38.10	AD	
65043-128LF	2 X 32	3.200/81.28	AD	
65043-129LF	2 X 15	1.500/38.10	AE	
65043-130LF	2 X 32	3.200/81.28	AE	
65043-131LF	2 X 22	2.200/55.88	AF	
65043-132LF	2 X 7	.700/17.78	AF	
65043-133LF	2 X 19	1.900/48.26	AF	
65043-134LF	2 X 12	1.200/30.48	AF	
65043-135LF	2 X 15	1.500/38.10	M	
65043-136LF	2 X 12	1.200/30.48	Z	
65043-137LF	2 X 18	1.800/45.72	Z	
65043-138LF	2 X 25	2.500/63.50	Z	
65043-139LF	2 X 36	3.600/91.44	Z	
65043-140LF	2 X 15	1.500/38.10	AG	
65043-141LF	2 X 7	.700/17.78	AG	

mat'l code	SEE NOTE 1	surface	tolerance	projection	product family
ltr	ecrn no	dr	date	ASME Y14.5 ✓ ASME Y14.5	PV HOUSINGS
bg				tolerances unless otherwise specified	title
				angles	MINI LATCH HOUSING
				0°±2'	DOUBLE ROW .100 [2.54] CC
				dr	M. CLOUSER 1990-01-31
				engr	C. TREXLER 1990-01-31
				chr	C. TREXLER 1990-01-31
				appd	C. TREXLER 1990-01-31
sheet index	revision sheet				type Product Customer Drawing



PRODUCT NO	NO OF POS	DIM K	SPECIAL MARKINGS STYLE	CUSTOMER RESTRICTED
65043-142LF	2 X 7	.700/17.78	D	
65043-143LF	2 X 3	.300/7.62	Y	
65043-144LF	2 X 5	.500/12.70	Y	
65043-145LF	2 X 10	1.000/25.40	Y	
65043-146LF	2 X 12	1.200/30.48	Y	
65043-147LF	2 X 13	1.300/33.02	Y	
65043-148LF	2 X 15	1.500/38.10	Y	
65043-149LF	2 X 17	1.700/43.18	Y	
65043-150LF	2 X 18	1.800/45.72	Y	
65043-151LF	2 X 20	2.000/50.80	Y	
65043-152LF	2 X 25	2.500/63.50	Y	
65043-153LF	2 X 35	3.500/88.90	Y	
65043-154LF	2 X 36	3.600/91.44	Y	
65043-155LF	2 X 30	3.000/76.20	E	
65043-156LF	2 X 13	1.300/33.02	AH	
65043-157LF	2 X 14	1.400/35.56	AJ	
65043-158LF	2 X 12	1.200/30.48	AK	
65043-159LF	2 X 27	2.700/68.58	D	
65043-160LF	2 X 12	1.200/30.48	E	
65043-161LF	2 X 24	2.400/60.96	E	
65043-162LF	2 X 12	1.200/30.48	D	
65043-163LF	2 X 4	.400/10.16	AG	
65043-164LF	2 X 23	2.300/58.42	AJ	
65043-165LF	2 X 7	.700/17.78	AJ	
65043-166LF	UNAVAILABLE			
65043-167LF	UNAVAILABLE			
65043-168LF	UNAVAILABLE			
65043-169LF	UNAVAILABLE			
65043-170LF	UNAVAILABLE			
65043-171LF	2 X 9	.900/22.86	AP	
65043-172LF	2 X 9	.900/22.86	AR	

mat'l code	SEE NOTE 1	surface ASME Y14.5 ✓	tolerance ASME Y14.5	projection	product family PV HOUSINGS
ltr	ec'n no	dr	date	tolerances unless otherwise specified	title
BG				angles XX±01/XX±3 XXX±005/XXX±3 0'±2' XXXX±0020/XXX±051	MINI LATCH HOUSING DOUBLE ROW .100 [2.54] CC
				INCH/MM scale 1:1	dwg no 65043 sheet 11 of 11 size A4
				dr M. CLOUSER 1990-01-31 engr C. TREXLER 1990-01-31 chr C. TREXLER 1990-01-31 appd C. TREXLER 1990-01-31	type Product Customer Drawing
sheet index	revision sheet				