

## MKDSN 1,5/ 5-5,08

Order No.: 1729157

The figure shows a 10-position version of the product

<http://eshop.phoenixcontact.de/phoenix/treeViewClick.do?UID=1729157>

Printed circuit terminal block, nominal current: 13.5 A, rated voltage: 250 V, pitch: 5.08 mm, no. of positions: 5, mounting: Soldering, type of connection: Screw connection, connection direction from the conductor to the PCB: 0°

### Commercial data

EAN	4017918026028
Pack	50 Pcs.
Customs tariff	85369010
Weight/Piece	0.0049 KG
Catalog page information	Page 53 (CC-2007)

### Product notes

WEEE/RoHS-compliant since:  
01/01/2003



<http://www.download.phoenixcontact.com>  
Please note that the data given here has been taken from the online catalog. For comprehensive information and data, please refer to the user documentation. The General Terms and Conditions of Use apply to Internet downloads.

### Technical data

#### Dimensions / positions

Pitch	5.08 mm
Dimension a	20.32 mm
Number of positions	5

---

Pin dimensions	0,5 x 1 mm
Hole diameter	1.3 mm
Screw thread	M 3
Tightening torque, min	0.5 Nm

**Technical data**

Insulating material group	I
Rated surge voltage (III/3)	4 kV
Rated surge voltage (III/2)	4 kV
Rated surge voltage (II/2)	4 kV
Rated voltage (III/2)	400 V
Rated voltage (II/2)	630 V
Connection in acc. with standard	EN-VDE
Nominal current $I_N$	13.5 A
Nominal voltage $U_N$	250 V
Nominal cross section	1.5 mm <sup>2</sup>
Maximum load current	13.5 A
Insulating material	PA
Inflammability class acc. to UL 94	V0
Internal cylindrical gage	A1
Stripping length	6 mm

**Connection data**

Conductor cross section solid min.	0.14 mm <sup>2</sup>
Conductor cross section solid max.	1.5 mm <sup>2</sup>
Conductor cross section stranded min.	0.14 mm <sup>2</sup>
Conductor cross section stranded max.	1.5 mm <sup>2</sup>
Conductor cross section stranded, with ferrule without plastic sleeve min.	0.25 mm <sup>2</sup>
Conductor cross section stranded, with ferrule without plastic sleeve max.	1.5 mm <sup>2</sup>
Conductor cross section stranded, with ferrule with plastic sleeve min.	0.25 mm <sup>2</sup>
Conductor cross section stranded, with ferrule with plastic sleeve max.	1.5 mm <sup>2</sup>
Conductor cross section AWG/kcmil min.	26
Conductor cross section AWG/kcmil max	16

2 conductors with same cross section, solid min.	0.14 mm <sup>2</sup>
2 conductors with same cross section, solid max.	0.75 mm <sup>2</sup>
2 conductors with same cross section, stranded min.	0.14 mm <sup>2</sup>
2 conductors with same cross section, stranded max.	0.75 mm <sup>2</sup>
2 conductors with same cross section, stranded, ferrules without plastic sleeve, min.	0.25 mm <sup>2</sup>
2 conductors with same cross section, stranded, ferrules without plastic sleeve, max.	0.5 mm <sup>2</sup>
2 conductors with same cross section, stranded, TWIN ferrules with plastic sleeve, min.	0.5 mm <sup>2</sup>
2 conductors with same cross section, stranded, TWIN ferrules with plastic sleeve, max.	1 mm <sup>2</sup>

### Certificates / Approvals

#### Approval logo



#### CSA

Nominal voltage U <sub>N</sub>	300 V
Nominal current I <sub>N</sub>	10 A
AWG/kcmil	28-14

#### CUL

Nominal voltage U <sub>N</sub>	300 V
Nominal current I <sub>N</sub>	10 A
AWG/kcmil	30-14

#### UL

Nominal voltage U <sub>N</sub>	300 V
Nominal current I <sub>N</sub>	10 A
AWG/kcmil	30-14
Certification	CB, CCA, CSA, CUL, GL, GOST, SEV, UL

**Accessories**

Item	Designation	Description
<b>Marking</b>		
1051993	B-STIFT	Marker pen, for manual labeling of unprinted Zack strips, smear-proof and waterproof, line thickness 0.5 mm
0804293	SK 5,08/3,8:FORTL.ZAHLEN	Marker card, printed horizontally, self-adhesive, 12 identical decades marked 1-10, 11-20 etc. up to 91-(99)100, sufficient for 120 terminal blocks
0805085	SK 5,08/3,8:SO	Marker card, special printing, self-adhesive, labeled acc. to customer requirements, 12 identical marker strips per card, max. 25-position labeling per strip, color: white
0805412	SK 5,08/3,8:UNBEDRUCKT	Marker cards, unprinted, with pitch divisions, self-adhesive, 10-section marker strips, 12 strips per card, can be labeled with the M-PEN
<b>Tools</b>		
1205053	SZS 0,6X3,5	Screwdriver, bladed, matches all screw terminal blocks up to 4.0 mm <sup>2</sup> connection cross section, blade: 0.6 x 3.5 mm, without VDE approval

**Drawings**

Drilling diagram

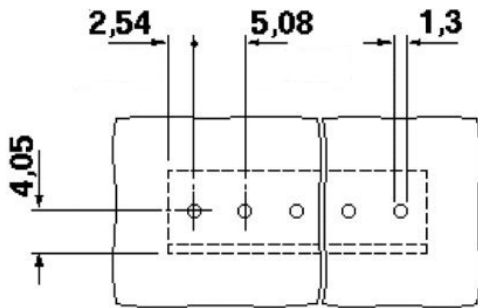

Dimensioned drawing

