	TYPE	PRODUCT SPECIFICATION		NUMBER	BUS-12-082			
	TITLE	Quickie™ Connector System			PAGE	1 of 20	REVISION	F
				AUTHORIZED BY	M.Barrios		DATE	31 Jul 06
				CLASSIFICATION	UNRESTRICTED			

## 1.0 GENERAL

### Scope

This specification covers the insulation piercing Quickie™ Connector designed for printed wiring board-to-flat cable (round conductor) interconnection in low power applications. In all applications the mated system (header to receptacle) plating should be gold to gold or tin to tin. The specification is composed of the following sections.

<u>Paragraph</u>	<u>Title</u>	<u>Page</u>
1.0	GENERAL	1
2.0	APPLICABLE DOCUMENTS	1
3.0	REQUIREMENTS	2
3.1	Qualification	2
3.2	Material	3
3.3	Finish	3
3.4	Design and Construction	7
3.5	Electrical Characteristics	9
3.6	Mechanical Characteristics	11
3.7	Environmental Conditions	13
4.0	QUALITY ASSURANCE PROVISIONS	17
4.1	Equipment Calibration	17
4.2	Inspection Conditions	17
4.3	Qualification Inspection	17
4.4	Quality Conformance Inspection	18
4.5	Acceptance Inspection	20

## 2.0 APPLICABLE DOCUMENTS

The following documents, of the issue in effect on the date of the latest revision of this specification, shall form a part of this specification to the extent specified herein.

### SPECIFICATIONS

#### Military

MIL-M-24519	Molding Plastics, Polyester, Thermoplastic
MIL-G-45204	Gold Plating, Electrodeposited
MIL-G-45662	Calibration System Requirement
MIL-P-55110	Printed Wiring Boards

	TYPE	PRODUCT SPECIFICATION		NUMBER	BUS-12-082	
	TITLE			PAGE	REVISION	
Quickie™ Connector System			2 of 20		F	
			AUTHORIZED BY		DATE	
			M.Barrios		31 Jul 06	
			CLASSIFICATION			
			UNRESTRICTED			

### Federal

- QQ-N-290 Nickel Plating (Electrodeposited)
- QQ-W-343 Wire, Electrical and Non-Electrical, Copper (Uninsulated)
- QQ-B-750 Bronze, Phosphor; Bar, Plate, Rod, Sheet Strip, Flat Wire, and Structural and Special Shaped Sections
- QQ-S-763 Steel Bars, Shapes, and Forgings, Corrosion-Resisting.
- QQ-C-533 Be - Cu

### STANDARDS

#### Military

- MIL-STD-I05 Sampling Procedures and Tables for Inspection by Attributes
- MIL-STD-202 Test Methods for Electronic and Electrical Component Parts
- MIL-STD-275 Printed Wiring Board for Electronic Equipment
- MIL-STD-I344 Test Methods for Electrical Connectors

#### Industry Specifications/Standards

- UL-94 Tests for Flammability of Plastic Materials

#### FCI Test Specifications

- BUS-12-001 Round Conductor Flat Flexible Cable

## **3.0 REQUIREMENTS**

### 3.1 Qualification

Connectors furnished under this specification shall be products capable of meeting the qualification test requirements specified herein.

### 3.2 Material

The material for each part shall be as specified herein, or equivalent. Substitute material shall meet the performance requirements of this specification.

3.2.1 Contact. Both the header and receptacle contact shall be full-hard phosphor bronze in accordance with QQ-B-750, Composition A.

3.2.2 Latch. The standard Quickie shall have a plastic molded-in latch.

	TYPE	PRODUCT SPECIFICATION		NUMBER	BUS-12-082			
	TITLE	Quickie™ Connector System			PAGE	3 of 20	REVISION	F
				AUTHORIZED BY	M.Barrios		DATE	31 Jul 06
				CLASSIFICATION	UNRESTRICTED			

3.2.3 **Plastic Parts.** Except as subsequently specified, all molded plastic parts of the receptacle connector and the mating header shall be filled polyester in accordance with MIL-M-24519, Type GPT-30F. Except as noted, all plastic material shall be rated flame retardant 94V-0 in accordance with UL-94.

3.2.3.1 **Header Locking Latches (Optional).** The latches shall be polyester in accordance with MIL-M-24519, Type PT-F.

3.2.3.2 **Strain Relief (Optional).** The strain relief shall be unfilled thermoplastic material.

3.2.3.3 **Keys (Optional).** The keys shall be unfilled Type 6-6 Nylon; the material shall be rated flame retardant 94V-2 in accordance with UL-94.

### 3.3 Finish

The finish for each part shall be as specified herein. Substitute finishes shall meet the performance requirements of this specification.

3.3.1 Both the header and receptacle contacts shall be plated with either gold per MIL-45204B, GXT, or with tin-lead. Nickel shall be plated per QQ-N-290, Class 2.

#### 3.3.2 QUICKIE II CONNECTOR SYSTEM

##### DUAL BEAM PHOSPHOR BRONZE FEMALE CONTACT

Receptacle Contact Plating Designation	Mating Contact Portion	Remainder of Terminal
0.76um/30 u" Au	0.76um/30 u" Au Over 1.27um/50 u" Ni	1.27um/50 u" Ni

	TYPE PRODUCT SPECIFICATION	NUMBER BUS-12-082		
	TITLE Quickie™ Connector System	PAGE 4 of 20	REVISION F	
		AUTHORIZED BY M.Barrios	DATE 31 Jul 06	
		CLASSIFICATION UNRESTRICTED		

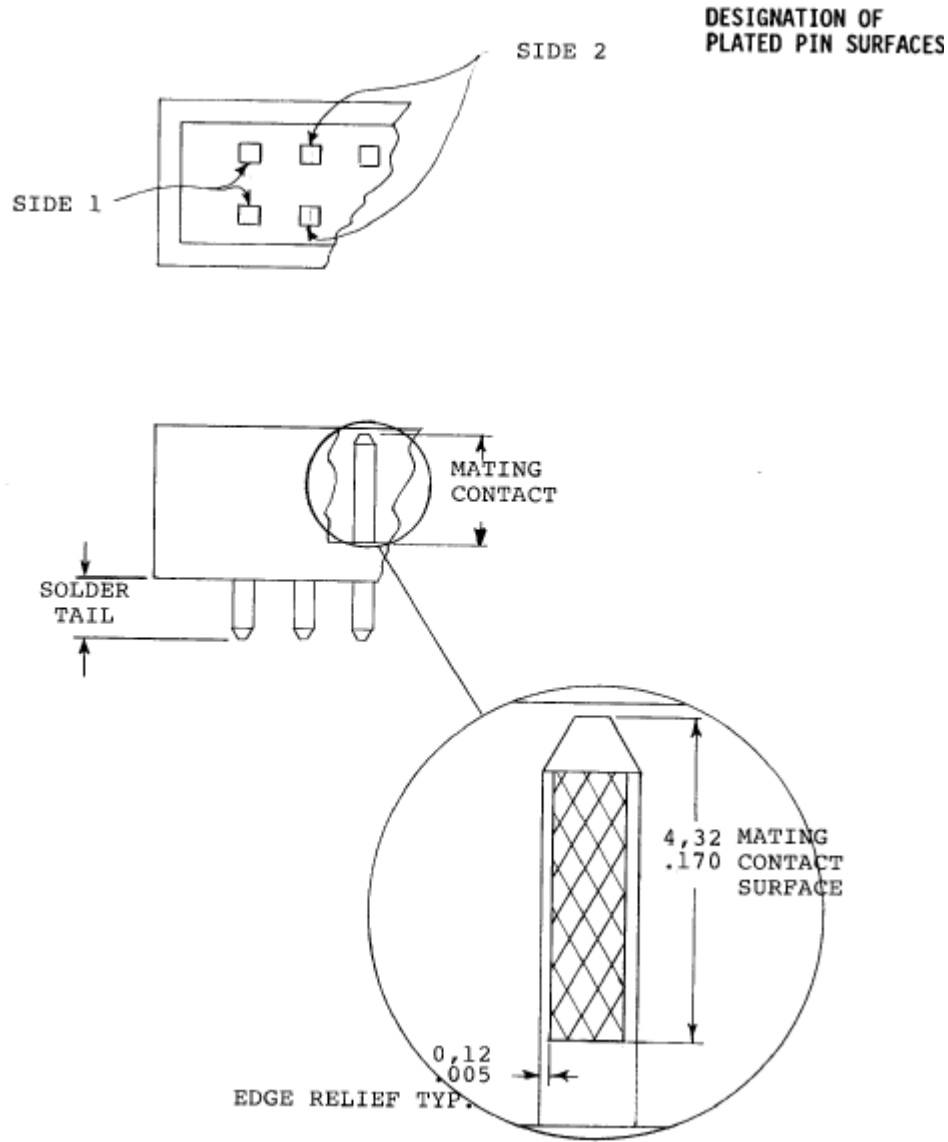

**FIGURE 1**

	TYPE	NUMBER	
	PRODUCT SPECIFICATION	BUS-12-082	
TITLE Quickie™ Connector System	PAGE	REVISION	
	5 of 20	F	
	AUTHORIZED BY	DATE	
M.Barrios	31 Jul 06		
CLASSIFICATION		UNRESTRICTED	

### QUICKIE II HEADERS

AVAILABLE IN BOTH ROUND AND SQUARE PINS

SAME PLATING ON HEADER CONTACT AND SOLDER TAIL

Mating Contact Plating Designation	Pin Surface See Figure 1	Plating Detail
0.76um/30um Au	ALL PIN SIDES	0.76um/30 u" Au over 1.27um/50 u" Ni
0.76um/30um GXT	ALL PIN SIDES	0.69um/27 u" Pb-Ni WITH 0.07um/3 u" Au FLASH OVER 1.27um/50 u" Ni

### QUICKIE III & EURO QUICKIE HEADERS

AVAILABLE IN SQUARE PIN CONFIGURATION

DUPLEX PLATING WITH THE FOLLOWING SOLDER TAIL

PLATING ON ALL VERSIONS - 3.81mm/150 u" MIN TIN-LEAD

Mating Contact Plating Designation	Pin Surface See Figure 1	Plating Detail
TIN-LEAD	ALL PIN SIDES	3.81um/150 u" MIN TIN-LEAD OVER 1.27um/50 u" Ni
0.76um/30 GXT	ALL PIN SIDES	0.69um/27 u" Pb-Ni with 0.07um/3 u" Au Flash OVER 1.27um/50u" Ni
0.76um/30 u" Au	ALL PIN SIDES	0.76um/30 u" Au OVER 1.27um/50 u"
1.27um/50 u" Au	ALL PIN SIDES	1.27um/50 u" Au OVER 1.27um/50" Ni

### 3.4 Design and Construction

	TYPE	PRODUCT SPECIFICATION		NUMBER	BUS-12-082		
	TITLE	Quickie™ Connector System		PAGE	6 of 20	REVISION	F
				AUTHORIZED BY	M.Barrios	DATE	31 Jul 06
				CLASSIFICATION	UNRESTRICTED		

The connector system shall be of two-piece design, consisting of: a molded, straight or right-angle, shielded header having .64/0.025 diameter or .64/0.025 square header contacts arranged for printed wiring board termination on a 2.54/0.100 square grid; and a multi-piece receptacle connector having self-stripping contact terminations for flat, flexible, round conductor cable on a 1.27/0.050 inch center and either one single-ended or two single-ended cantilever members for interfacing with the header contact.

NOTE: While the receptacle connector will mate with any .64/0.025 diameter or .64/0.025 square header contacts on an appropriate grid, performance of such a combination must be determined by actual test. Minimum pin length is 4.32/.170", maximum pin length is 6.35/.250". Recommended pin length is 5.84/.230".

### 3.4.1 Installation.

3.4.1.1 **Header.** The header shall mount on single- or double-sided or multi-layered printed wiring board of any thickness to  $\pm .08/.003$  inch (Size 4) having  $.89/0.035 \pm 0.003$  diameter holes (Round Pin) or  $1.02/.040 \pm .08/.003$  diameter holes (square pin) on a 2.54/0.0100 square grid. The termination layout shall be in accordance with the printed wiring requirements of MIL-STD-275 and MIL-P-55110.

3.4.1.2 **Receptacle.** The receptacle shall simultaneously terminate up to 60 wires size AWG #28 (stranded) or AWG #30 (solid) on 1.27/0.050 inch centers without pre-stripping the PVC (polyvinylchloride) cable insulation. The cable shall conform to the requirements of specifications BUS-12-001.

3.4.2 Latching Mechanism. An optional latching mechanism shall be available for locking the plug into the receptacle to withstand service conditions without disconnecting.

3.4.3 Strain Relief. An optional strain relief shall be available to protect the receptacle terminations against pull and flexing forces.

3.4.4 Polarizing Feature. An optional molded-in polarizing feature shall be available to insure correct orientation of the receptacle connector and its mating header.

	TYPE	NUMBER	
	PRODUCT SPECIFICATION	BUS-12-082	
TITLE Quickie™ Connector System	PAGE	REVISION	
	7 of 20	F	
	AUTHORIZED BY	DATE	
M.Barrios	31 Jul 06		
	CLASSIFICATION	UNRESTRICTED	

- 3.4.5 Keying. An optional key(s) shall be available for installation in individual positions in the receptacle connector to permit selective identification or programming.
- 3.4.6 Mating. The connector shall be capable of mating and unmating by hand without the use of special tools within the specified temperature range.
- 3.4.7 Workmanship. Connectors shall be uniform in quality and shall be free from burrs, scratches, cracks, voids, chips, blisters, pin holes, sharp edges, and other defects that will adversely affect life or serviceability.
- 3.4.8 Interchangeability. Any header shall be capable of mating with any receptacle of the same contact population without degradation in performance.

### 3.5 Electrical Characteristics

- 3.5.1 Current Rating. The maximum current rating of the connector shall be 1.0 ampere DC.
- 3.5.2 Contact Resistance. The contact resistance shall not exceed 10 milliohms (15 milliohms after exposure to the environments described in paragraphs 3.6.5 and 3.7.1 to 3.7.7) when measured in accordance with MIL-STD-202, Method 307. The following details shall apply:
  - (a) Method of Connection - attach current and voltage leads as shown in Figure 1.
  - (b) Test Current - 1.0 ampere DC.
- 3.5.3 Low Level Circuit Resistance. The low level circuit resistance shall not exceed 10 milliohms (15 milliohms after exposure to the environments described in paragraphs 3.6.5 and 3.7.1 to 3.7.7) when measured in accordance with MIL-STD-1344, Method 3002. The following details shall apply.
  - (a) Method of Connection - see Figure 2
  - (b) Test Current - 1 milliampere DC
  - (c) Maximum Open Circuit Voltage-20 millivolts DC

	TYPE	NUMBER	
	PRODUCT SPECIFICATION	BUS-12-082	
TITLE Quickie™ Connector System	PAGE	8 of 20	REVISION
	AUTHORIZED BY	M.Barrios	DATE
			31 Jul 06
CLASSIFICATION		UNRESTRICTED	

3.5.4 Insulation Resistance. The insulation resistance of mated connectors shall be not less than 50,000 megohms (20,000 megohms after exposure to the humidity environment described in paragraph 3.7.1) when measured in accordance with MIL-STD-202, Method 302. The following details shall apply:

- (a) Test Condition - B (500 volts DC)
- (b) Special Preparation\* - the header and receptacle shall not be terminated.
- (c) Points of Measurement - between adjacent contact positions.

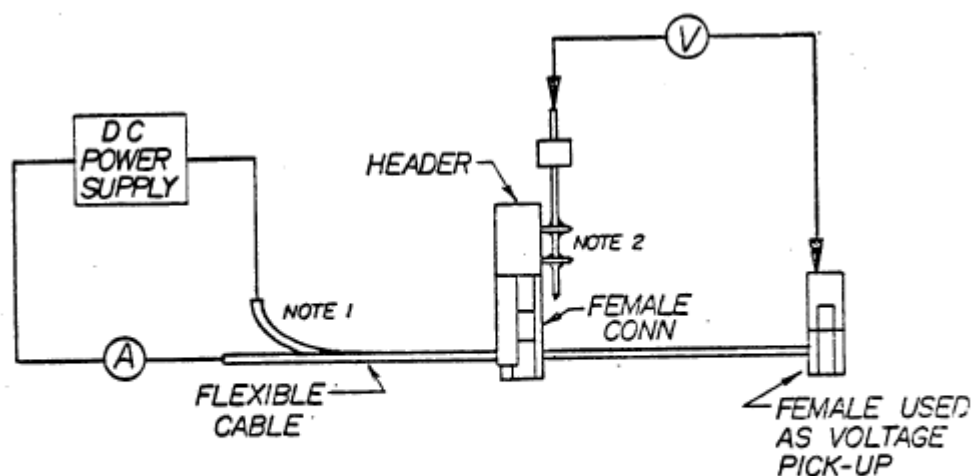

- NOTES:**
1. Current connected to first and last conductor; adjacent intermediate leads shorted.
  2. Berg Stik used to short alternate terminals in complementary pattern to cable conductors.
  3. Voltmeter lead piercing cable insulation.

**FIGURE 2 - CONTACT RESISTANCE**



	TYPE	PRODUCT SPECIFICATION		NUMBER	BUS-12-082	
	TITLE			PAGE	REVISION	
Quickie™ Connector System			9 of 20		F	
			AUTHORIZED BY		DATE	
			M.Barrios		31 Jul 06	
			CLASSIFICATION			
			UNRESTRICTED			

- 3.5.5 Dielectric Withstanding Voltage. There shall be no evidence of arc-over, insulation breakdown, or excessive leakage current (> 1 milliampere) when the mated connectors are tested in accordance with MIL-STD-202, Method 301. The following details shall apply:
- (a) Test Potential - 1,000 volts RMS, 60 Hz at sea-level pressure 450 volts RMS, 60 Hz at 50,000 feet simulated altitude.
  - (b) Test Duration - 60 seconds
  - (c) Special Preparation\* - the header and receptacle shall not be terminated.
  - (d) Points of Measurement - between adjacent contact positions.

### 3.6 Mechanical Characteristics

- 3.6.1 Cable Retention. The strain relief on the receptacle shall withstand an evenly distributed force of 10 pounds per-inch-of-cable-width (.146 Newtons per-millimeter-of-cable-width) applied to the cable in a direction parallel to the contact axis.

- 3.6.2 Cable Flex Resistance\*\*. With strain relief installed, the receptacle shall withstand 100 cycles of cable flexing. The following details shall apply:

- (a) Tension on Cable - 2 pounds per-inch-of-cable-width (0.029 Newtons per-millimeter-of-cable width)
- (b) Flex Angle - 140° as shown in Figure 3.

\* The layout of land areas on printed wiring boards and the proximity of adjacent conductors at the cut end of flexible cables can affect this characteristic and, therefore, are necessarily excluded in its specification.

\*\* Stranded wire only; solid conductors will not withstand flexing, whether or not a connector is installed.

- 3.6.3 Total Mating Force. The total force to mate the header and receptacle shall not exceed the values shown in Table I.

	TYPE	NUMBER	
	PRODUCT SPECIFICATION	BUS-12-082	
TITLE Quickie™ Connector System	PAGE	10 of 20	REVISION F
	AUTHORIZED BY M.Barrios	DATE 31 Jul 06	
	CLASSIFICATION UNRESTRICTED		

TABLE I - TOTAL INSERTION FORCE

Contact Population	Force Pounds	Nts.
2 X 3	3	13.4
2 X 4	4	17.8
2 X 5	5	22.3
2 X 7	7	31.2
2 X 8	8	35.6
2 X 10	10	44.5
2 X 12	12	53.4
2 X 13	14	57.9
2 X 15	15	66.8
2 X 17	19	75.7
2 x 20	23	89
2 X 22	25	98
2 x 25	30	111.3
2 X 30	35	133.5
2 X 32	38	142.4

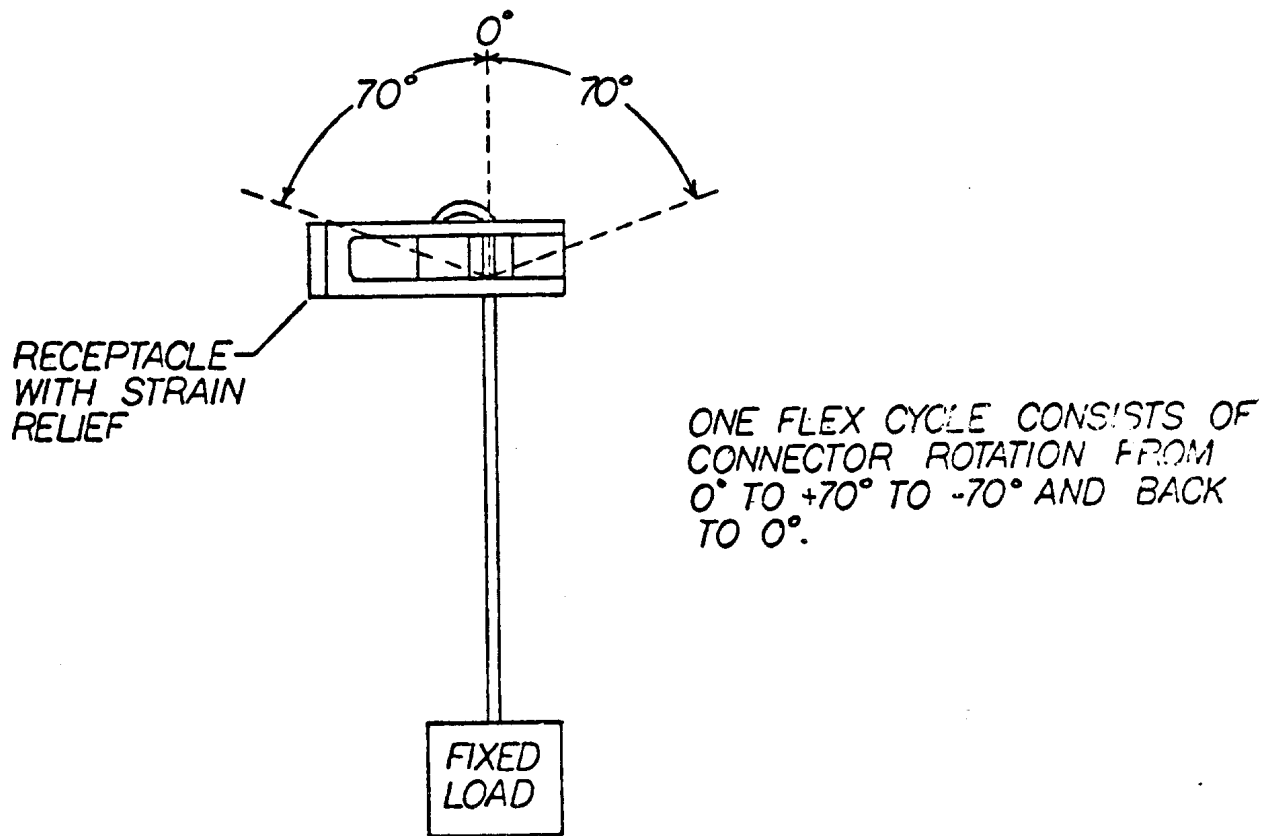

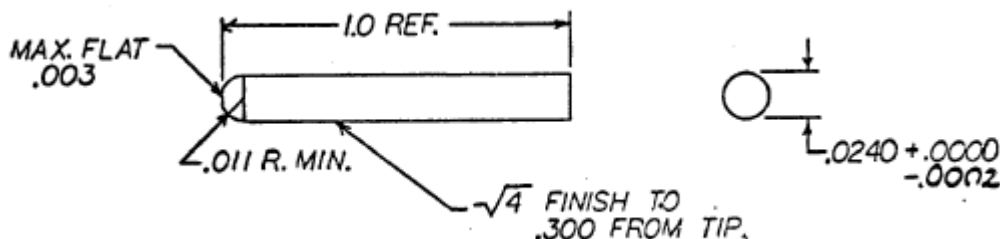

FIGURE 3 - CABLE FLEX RESISTANCE

	TYPE	NUMBER	
	PRODUCT SPECIFICATION	BUS-12-082	
TITLE	Quickie™ Connector System	PAGE	REVISION
		11 of 20	F
		AUTHORIZED BY	DATE
		M.Barrios	31 Jul 06
		CLASSIFICATION	
		UNRESTRICTED	

3.6.4 Individual Contact Separation Force. When measured using a gage configured as shown in Figure 4, the individual contact separation force shall be not less than 25 grams.



**FIGURE 4 - SEPARATION FORCE GAGE**

3.6.5 Durability. After 100 mating cycles of the header and receptacle receptacle, the individual contact separation force shall be not less than specified above (see paragraph 3.6.4) and the contact resistance shall not exceed 15 milliohms (see paragraph 3.5.2).

3.6.6 Contact to Housing Retention. The force required to dislodge the receptacle terminal from its housing cavity shall be 1 Lb. minimum prior to cable termination or assembly of strain reliefs.

### 3.7 Environmental Conditions

3.7.1 Humidity. Within 1 hour after exposure of the mated connector to a high humidity environment, the insulation resistance of an unterminated connector shall be not less than 20,000 megohms (see paragraph 3.5.4); the contact resistance of a terminated connector shall not exceed 15 milliohms (see paragraph 3.5.2). The test shall be in accordance with MIL-STD-202, Method 103; the following details shall apply:

- (a) Test Duration - 96 hours
- (b) Relative Humidity - 90% minimum
- (c) Temperature - 40°C

	TYPE	PRODUCT SPECIFICATION		NUMBER	BUS-12-082			
	TITLE	Quickie™ Connector System			PAGE	12 of 20	REVISION	F
				AUTHORIZED BY	M.Barrios		DATE	31 Jul 06
				CLASSIFICATION	UNRESTRICTED			

- 3.7.2 Thermal Shock. After exposure of the mated connector to alternate periods of extreme high and low temperature, there shall be no evidence of cracking or crazing of the insulator or other physical damage to the connector; the dielectric withstanding voltage of an unterminated connector shall be not less than 1,000 volts RMS, 60 Hz (see paragraph 3.5.5). The test shall be in accordance with MIL-STD-202, Method 107; the following details shall apply:
- (a) Test Condition - B (1 hour cycles)
  - (b) Temperature Range\* - -65 to +105°C
- 3.7.3 High Temperature Life. After exposure of the mated connector to a high temperature operating environment, the insulation resistance of an unterminated connector shall be not less than 100,000 megohms (see paragraph 3.5.4); the contact resistance of a terminated connector shall not exceed 15 milliohms (see paragraph 3.5.2). The test shall be in accordance with MIL-STD-202, Method 108; the following details shall apply:
- (a) Test Chamber Temperature - 85°C
  - (b) Test Condition (Duration)- B (250 hours)
  - (c) Operating Conditions - 1.0 ampere DC current (rated) through all contacts of terminated connector; duty cycle: 45 minutes ON and 15 minutes OFF.
- 3.7.4 Shock. There shall be no evidence of physical or mechanical damage when the mated connectors are subjected to transient accelerations. During and after each shock, the contacts shall evidence no discontinuity greater than 1 microsecond. The test shall be in accordance with MIL-STD-202, Method 213. The following details shall apply:
- (a) Test Condition - I (100G, 6ms sawtooth)
  - (b) Number of Shocks - 3 shocks in each direction along three orthogonal axes (18 total)
  - (c) Mounting - see Figure 5

	TYPE	PRODUCT SPECIFICATION		NUMBER	BUS-12-082		
	TITLE	Quickie™ Connector System		PAGE	13 of 20	REVISION	F
				AUTHORIZED BY	M.Barrios	DATE	31 Jul 06
				CLASSIFICATION	UNRESTRICTED		

3.7.5 Vibration. There shall be no evidence of physical or mechanical damage when the mated connectors are subjected to prolonged mechanical vibration; during the vibration along each axis, the contacts shall evidence no discontinuity greater than 1 microsecond. At the completion of the test, the individual contact separation force shall be not less than specified in paragraph 3.6.4 and the contact resistance shall not exceed 15 milliohms (see paragraph 3.5.2). The test shall be in accordance with MIL-STD-202, Method 204; the following details shall apply:

- (a) Test Condition - B ( $\pm 15G$ , 10 to 2,000 Hz)
- (b) Test Duration - 4 hours along each of three orthogonal axes (12 hours total)
- (c) Mounting - see Figure 5

\* The high temperature limit for polyester is  $+150^{\circ}C$ ; however, the PVC insulation of the cable restricts the assembly to  $+105^{\circ}C$ .

3.7.6 Hydrogen Sulfide ( $H_2S$ ) Exposure. After exposure of the mated connectors to an  $H_2S$  atmosphere, the low level circuit resistance shall not exceed 15 milliohms (see paragraph 3.5.3). The following details shall apply:

- (a) Test Medium - solution of 120 grams of  $Na_2S \cdot 9H_2O$  in 500 ml of distilled water, with 14 grams of  $K_2HPO_4$  added immediately prior to test.
- (b) Test Temperature -  $40^{\circ}C$
- (c) Test Duration - 48 hours in a sealed 9000 cc glass container.

3.7.7 Salt Spray. After exposure of the mated connectors to a salt fog atmosphere, the low level circuit resistance and contact resistance shall not exceed 15 milliohms (see paragraphs 3.5.3 and 3.5.2, respectively) when measured in that order. The test all be in accordance with MIL-STD-202, Method 101; the following details shall apply:

- (a) Salt Solution - 5 percent by weight
- (b) Test Condition - B (48 hours)

	TYPE PRODUCT SPECIFICATION	NUMBER BUS-12-082	
	TITLE Quickie™ Connector System	PAGE 14 of 20	REVISION F
		AUTHORIZED BY M.Barrios	DATE 31 Jul 06
CLASSIFICATION UNRESTRICTED			

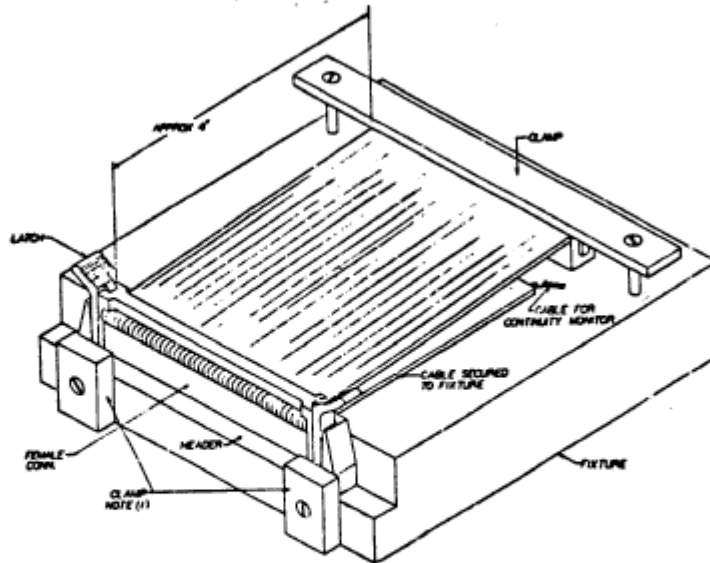

- NOTE:**
1. Clamps secure header and latches similar to PWB mounting; female connector secured only by latches.
  2. Upper portion of cable unsupported over indicated length.

**FIGURE 5 - MOUNTING FOR SHOCK AND VIBRATION**

	TYPE	PRODUCT SPECIFICATION		NUMBER	BUS-12-082			
	TITLE	Quickie™ Connector System			PAGE	15 of 20	REVISION	F
				AUTHORIZED BY	M.Barrios		DATE	31 Jul 06
				CLASSIFICATION	UNRESTRICTED			

#### 4.0 QUALITY ASSURANCE PROVISIONS

##### 4.1 Equipment Calibration

All test equipment and inspection facilities used in the performance of any test shall be maintained in a calibration system in accordance with MIL-C-45662.

##### 4.2 Inspection Conditions

Unless otherwise specified herein, all inspections shall be performed under the following ambient conditions.

- (a) Temperature -  $25^{\circ}\text{C} \pm 5^{\circ}\text{C}$
- (b) Relative Humidity - 30 to 80%
- (c) Barometric Pressure - Local Ambient

##### 4.3 Qualification Inspection

Qualification inspection shall be performed on sample units produced with equipment and procedures normally used in production.

- 4.3.1 Sample. Six (6) of the largest and three (3) of the smallest population connectors shall be subjected to the qualification inspection.
- 4.3.2 Preparation of Samples. The various test samples shall be configured and terminated as shown in Table II.
- 4.3.3 Test Sequence. The sample connectors shall be subjected to the inspections specified in Table III in the order shown.

	TYPE	PRODUCT SPECIFICATION		NUMBER	BUS-12-082		
	TITLE			PAGE	REVISION		
Quickie™ Connector System			16 of 20		F		
			AUTHORIZED BY		DATE		
			M.Barrios		31 Jul 06		
			CLASSIFICATION				
			UNRESTRICTED				

**TABLE II - TEST SAMPLE DESCRIPTION**

Sample Number	Number of Contacts	Strain Relief	Wire Latches	Size	Type	Length
1	2 x 25	Yes	No	AWG 28	Stranded	10"
2	2 x 25	No	No	AWG 28	Stranded	10"
3	2 x 25	No	No	--	None	--
4	2 x 25	Yes	Yes	AWG 28	Stranded	10"
5	2 x 25	Yes	Yes	AWG 28	Stranded	10"
6	2 x 25	No	No	AWG 30	Solid	10"
7	2 x 5	Yes	No	AWG 28	Stranded	10"
8	2 x 5	Yes	Yes	AWG 28	Stranded	10"
9	2 x 5	No	No	AWG 30	Solid	10"

**TABLE III - CONNECTOR QUALIFICATION INSPECTION**

Examination or Test	Paragraph	Sample Number									
		1	2	3	4	5	6	7	8	9	
Total Mating Force	3.6.3	-	-	-	X	X	X	X	X	X	
Individual Contact Separation Force	3.6.4	-	-	-	X	X	X	-	-	-	
Contact to Housing Retention	3.6.6	-	X	-	-	-	-	-	-	-	
Cable Retention	3.6.1	-	-	-	-	x	-	-	X	-	
Cable Flex Resistance	3.6.2	X	-	-	X	-	-	X	-	-	
Contact Resistance	3.5.2	X	X	-	X	X	X	X	X	X	
Insulation Resistance	3.5.4	-	-	X	-	-	-	-	-	-	
Dielectric Withstanding Voltage	3.5.5	-	-	X	-	-	-	-	-	-	
Thermal Shock	3.7.2	X	-	X	-	-	-	-	-	-	
Humidity	3.7.1	X	X	X	-	-	-	-	-	-	
High Temperature Life	3.7.3	X	X	X	-	-	-	-	-	-	
Shock	3.7.4	-	-	-	X	X	-	-	-	-	
Vibration	3.7.5	-	-	-	X	X	-	-	-	-	
Durability	3.6.5	-	-	X	-	X	X	X	X	X	
Hydrogen Sulfide Exposure	3.7.6	-	-	-	X	X	X	X	X	X	
Salt Spray*	3.7.7	-	-	-	X	X	X	X	X	X	

\* This test not applicable to tin plated connectors.

4.4 Quality Conformance Inspection. Quality conformance inspection shall be performed on sample units produced with equipment and procedures normally used in production.

4.4.1 Sample. Six (6) of the largest population connectors shall be selected at random and subjected to quality conformance inspection.



	TYPE	NUMBER	
	PRODUCT SPECIFICATION	BUS-12-082	
TITLE Quickie™ Connector System		PAGE	REVISION
		17 of 20	F
		AUTHORIZED BY	DATE
		M.Barrios	31 Jul 06
		CLASSIFICATION UNRESTRICTED	

4.4.2 Preparation of Samples. The various test samples shall be configured as shown in Table IV.

**TABLE IV - TEST SAMPLE DESCRIPTION**

Sample Number	Number of Contacts	Strain Relief	Latches	Flexible Cable		
				Wire Size	Type	Length
1	2 x 25	Yes	No	AWG 28	Stranded	254mm/10"
2	2 x 25	No	No	AWG 28	Stranded	254mm/10"
3	2 x 25	No	No	None	- - -	- - -
4	2 x 25	Yes	No	AWG 28	Stranded	254mm/10"
5	2 x 25	Yes	No	AWG 28	Stranded	254mm/10"
6	2 x 25	No	No	AWG 30	Solid	254mm/10"

4.4.3 Test Sequence. The sample connectors shall be subjected to the inspections specified in Table V in the order shown.

**TABLE V - QUALITY CONFORMANCE INSPECTION**

<u>Examination or Test</u>	Sample Number <u>Paragraph</u>	<u>1 2 3 4 5 6</u>					
		Total Mating Force	3.6.3	-	-	-	X
Individual Contact Separation Force	3.6.4	-	-	-	X	X	X
Cable Retention	3.6.1	-	-	-	-	X	-
Cable Flex Resistance	3.6.2	X	-	-	X	-	-
Contact Resistance	3.5.2	X	X	-	X	X	X
Insulation Resistance	3.5.4	-	-	X	-	-	-
Dielectric Withstanding Voltage	3.5.5	-	-	X	-	-	-
Thermal Shock	3.7.2	X	-	X	-	-	-
Humidity	3.7.1	X	X	X	-	-	-
Durability	3.6.5	-	-	-	X	-	X
Hydrogen Sulfide Exposure	3.7.6	-	-	-	X	X	X
Salt Spray*	3.7.7	-	-	-	X	X	X

\* This test not applicable to tin plated connectors.

4.4.4 Failures. If a connector fails to pass the quality conformance inspection, appropriate corrective action shall be taken on the materials or processes and additional sample units shall be subjected to the quality conformance inspection to verify the effectiveness of the action.

	TYPE	PRODUCT SPECIFICATION		NUMBER	BUS-12-082			
	TITLE	Quickie™ Connector System			PAGE	18 of 20	REVISION	F
				AUTHORIZED BY	M.Barrios		DATE	31 Jul 06
				CLASSIFICATION	UNRESTRICTED			

4.4.5 Disposition of Sample Units. Sample units that have been subjected to the quality conformance inspection shall not be considered deliverable on the contract or purchase order.

4.5 Acceptance Inspection

Acceptance inspection shall consist of the examinations and inspections specified in Table VI.

**TABLE VI - ACCEPTANCE INSPECTION**

<u>Examination</u>	<u>AQL</u>	
	<u>Major</u>	<u>Minor</u>
Visual & Mechanical	1.0%	4.0%

4.5.1 Inspection Lot. An inspection lot shall consist of all connectors produced under essentially the same conditions and offered for inspection at one time.

4.5.2 Sampling Plan. Statistical sampling and inspection shall be in accordance with MIL-STD-105 for General Inspection, Level II. The acceptable quality level (AQL) shall be as specified in Table VI. Major and minor defects shall be as defined in MIL-STD-105.

4.5.3 Rejected Lots. Rejected lots shall be reworked to correct the defects or screened to remove defective units and re-submitted for inspection.

4.5.4 Disposition of Sample Units. Sample units that have been subjected to the acceptance inspection shall be considered deliverable on the contract or purchase order.

	TYPE	PRODUCT SPECIFICATION		NUMBER	BUS-12-082	
	TITLE			PAGE	REVISION	
Quickie™ Connector System			19 of 20		F	
			AUTHORIZED BY		DATE	
			M.Barrios		31 Jul 06	
			CLASSIFICATION			
			UNRESTRICTED			

**REVISION RECORD**

<u>REV</u>	<u>PAGE</u>	<u>DESCRIPTION</u>	<u>EC #</u>	<u>DATE</u>
A	All	Page 2 - change "Berg" to "DuPont"	15773	11/10/88
	5	Remove "This product is pre-plated"		
	10	Add metric equivalent		
	13	Add metric equivalent		
	14	Add sizes & metric equivalents		
	16	Add "and Euro Qke"		
	18	Remove 25 gm. and reference 3.64 only		
	23	Add metric equivalent		
B	All		V11791	06/28/91
C	1-13	Changed references for male and female to header and receptacle Deleted charts on pg. 4 and 7 Change 64 to 60 in 3.4.1.2	V13143	11/12/91
D	All	Revised format to be consistent with GS-01-001, and change BERG, Dupont, etc. references to FCI.	V01904	08/01/00
E	12	Add 3.6.6 to Page 12	V03-1270	02/11/04
	17	Add 3.6.6 to Table III		
F	All	New FCI Logo	V06-0709	07/31/06