

Please note that the data given here has been taken from the online catalog. For comprehensive information and data, please refer to the user documentation at <http://www.download.phoenixcontact.com>. The General Terms and Conditions of Use apply to Internet downloads.

► Extract from the online catalog

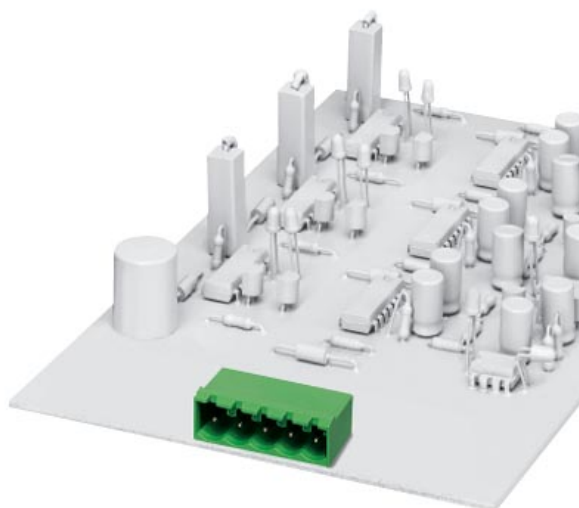

Header, nominal current: 12 A, rated voltage: 250 V,
pitch: 5.08 mm, no. of positions: 5, mounting: Soldering

The illustration shows version MSTBA 2,5/5-G-5,08 AU

Order No.	1757271
Ord designation	MSTBA 2,5/ 5-G-5,08
EAN	4017918029807
Pack	50 Pcs.
Customs tariff	85369010
Catalog page information	Page 167 (CC-2005)

► Technical data

Dimensions / positions

Pitch	5.08 mm
Dimension a	20.32 mm
Number of positions	5
Pin dimensions	1 x 1 mm
Hole diameter	1.4 mm

Technical data

Insulating material group	IIIa
Rated surge voltage (III/3)	4 kV
Rated surge voltage (III/2)	4 kV
Rated surge voltage (II/2)	4 kV
Rated voltage (III/2)	320 V
Rated voltage (II/2)	400 V
Connection in acc. with standard	EN-VDE
Nominal current I_N	12 A
Nominal voltage U_N	250 V
Maximum load current	12 A
Insulating material	PBT
Inflammability class acc. to UL 94	V0

► Certificates

Certificate logos

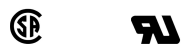

UL

Nominal voltage U_N	300 V
Nominal current I_N	10 A

CSA

Nominal voltage U_N	300 V
Nominal current I_N	10 A

► Drawings

Drilling diagram

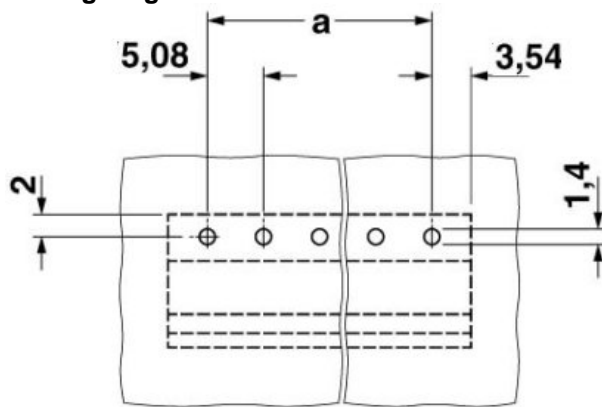

Diagram

Plug: QC 1/5-ST(F)-5,08
Header: MSTB(A) 2,5/5-G(F)-5,08

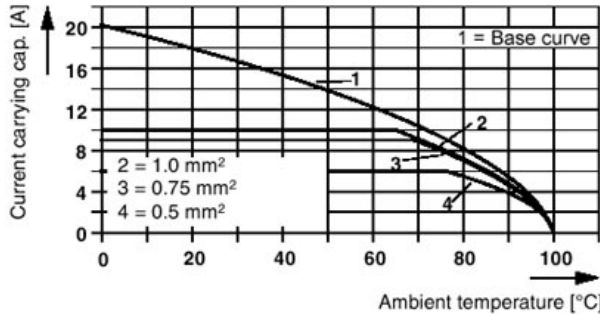

Plug: MSTBT 2,5/5-ST(F)-(-5,08)
Header: MSTB(A) 2,5/5-G(F)-(-5,08)

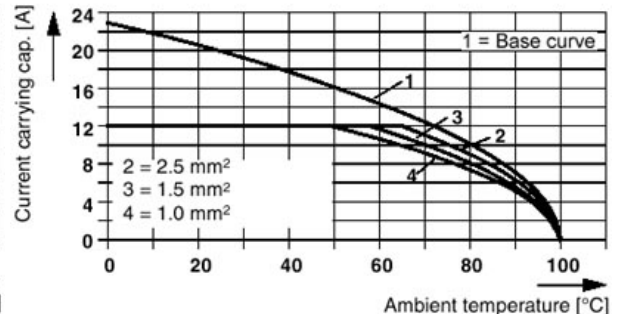

Plug: SMSTB 2,5/5-ST(F)-(-5,08)
Header: MSTB(A) 2,5/5-G(F)-(-5,08)

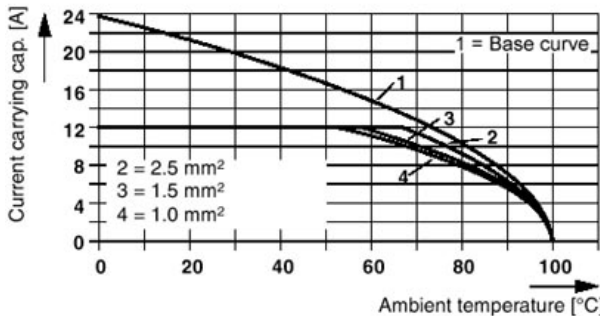

Plug: MVSTBR(W) 2,5/5-ST(F)-(-5,08)
Header: MSTB(A) 2,5/5-G(F)-(-5,08)

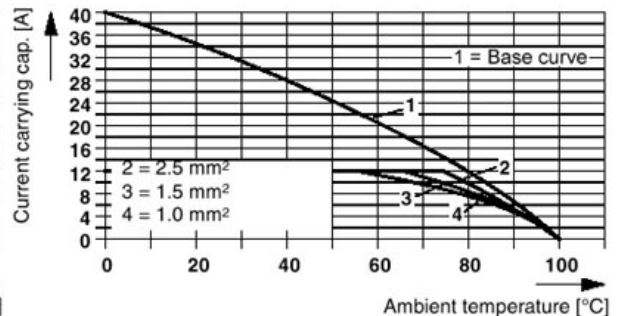

Plug: FRONT-MSTB 2,5/5-ST(F)-(-5,08)
Header: MSTB(A) 2,5/5-G(F)-(-5,08)

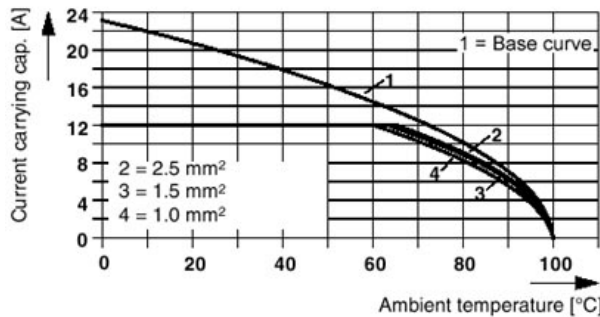

Plug: TMSTBP 2,5/5-ST(F)-(-5,08)
Header: MSTB(A) 2,5/5-G(F)-(-5,08)

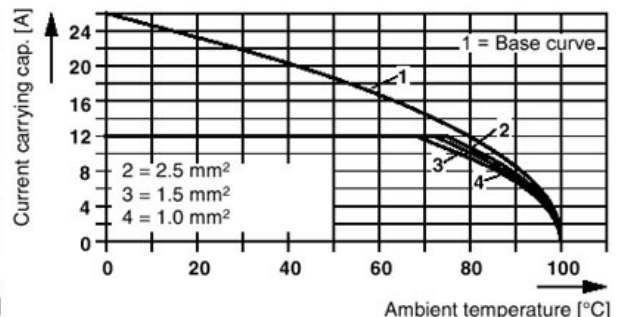

Plug: FKC 2,5/5-ST(F)-5,08
Header: MSTB(A) 2,5/5-G(F)-5,08

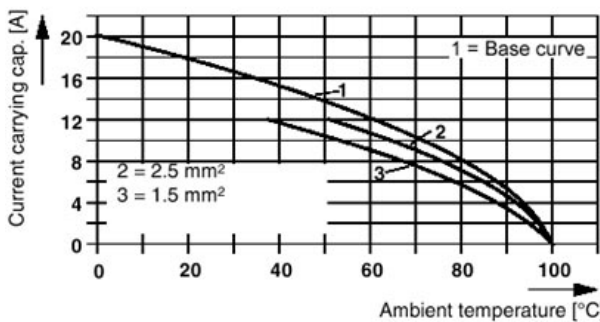

Plug: FKCVR(W) 2,5/5-ST(F)-5,08
Header: MSTB(A) 2,5/5-G(F)-5,08

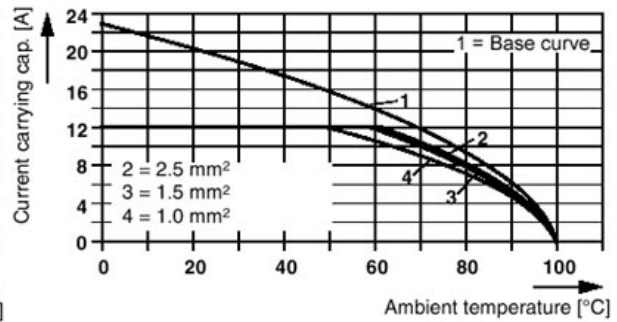

MSTBA 2,5/ 5-G-5,08



Plug: MSTB 2,5/5-ST(F)(-5,08)
Header: MSTBO 2,5/5-GR(L)(-5,08)

Plug: MSTB 2,5/5-ST(F)(-5,08)
Header: MSTB(A) 2,5/5-G(F)(-5,08)

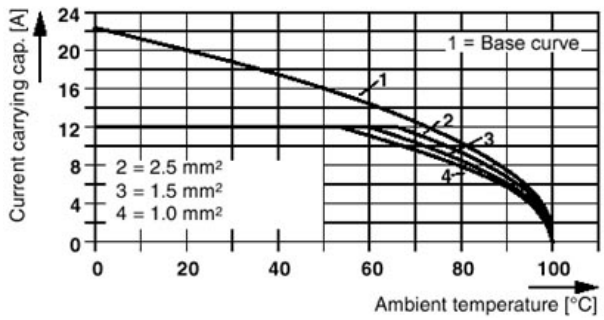
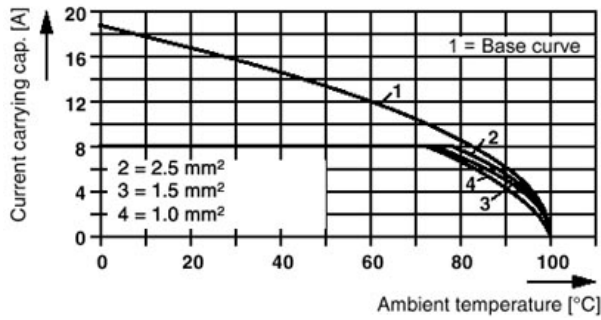

Dimensioned drawing

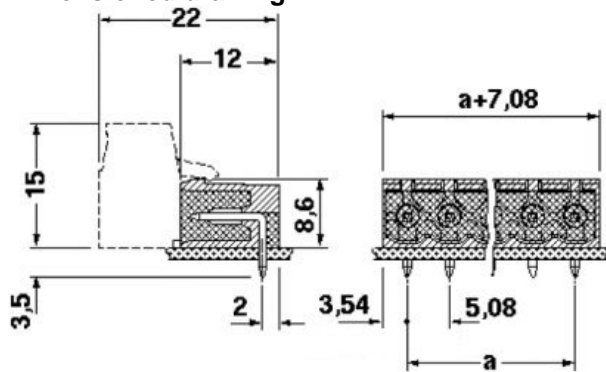

► Accessories

Item	Designation	Description
Assembly		
1755477	MSTB-BL	Keying cap, for forming sections, plugs onto header pin, green insulating material
Marking		
1051993	B-STIFT	Marker pen, for manual labeling of unprinted Zack strips, smear-proof and waterproof, line thickness 0.5 mm
0804293	SK 5,08/3,8:FORTL.ZAHLEN	Marker card, printed horizontally, self-adhesive, 12 identical decades marked 1-10, 11-20 etc. up to 91-(99)100, sufficient for 120 terminal blocks
0805085	SK 5,08/3,8:SO	Marker card, self-adhesive, marking according to customer requirements
0805412	SK 5,08/3,8:UNBEDRUCKT	Marker cards, unprinted, with pitch divisions, self-adhesive, 10-section marker strips, 12 strips per card, can be labeled with M-PEN
Plug/Adapter		
1734401	CR-MSTB	Coding element, inserted into the recess in the header or the inverted plug, red insulating material



► **Additional products**

Item	Designation	Description
------	-------------	-------------

General

1872729	A-ICV 2,5/ 5-G-5,08	Header, nominal current: 12 A, rated voltage: 250 V, pitch: 5.08 mm, no. of positions: 5, mounting: Mounting rail
1873087	FKC 2,5/ 5-ST-5,08	Plug component, nominal current: 12 A, rated voltage: 250 V, pitch: 5.08 mm, no. of positions: 5, type of connection: Spring-cage connection
1902149	FKCT 2,5/ 5-ST-5,08	Plug component, nominal current: 12 A, rated voltage: 250 V, pitch: 5.08 mm, no. of positions: 5, type of connection: Spring-cage connection
1873980	FKCVR 2,5/ 5-ST-5,08	Plug component, nominal current: 12 A, rated voltage: 250 V, pitch: 5.08 mm, no. of positions: 5, type of connection: Spring-cage connection
1873689	FKCVW 2,5/ 5-ST-5,08	Plug component, nominal current: 12 A, rated voltage: 250 V, pitch: 5.08 mm, no. of positions: 5, type of connection: Spring-cage connection
1777316	FRONT-MSTB 2,5/ 5-ST-5,08	Plug component, nominal current: 12 A, rated voltage: 320 V, pitch: 5.08 mm, no. of positions: 5, type of connection: Screw connection
1786433	IC 2,5/ 5-G-5,08	Header, nominal current: 12 A, rated voltage: 250 V, pitch: 5.08 mm, no. of positions: 5, mounting: Soldering
1785971	ICV 2,5/ 5-G-5,08	Header, nominal current: 12 A, rated voltage: 250 V, pitch: 5.08 mm, no. of positions: 5, mounting: Soldering
1757048	MSTB 2,5/ 5-ST-5,08	Plug, nominal current: 12 A, rated voltage: 250 V, pitch: 5,08 mm, no. of positions: 5, type of connection: Screw connection
1776142	MSTB 2,5/ 5-STZ-5,08	Plug, nominal current: 12 A, rated voltage: 250 V, pitch: 5,08 mm, no. of positions: 5, type of connection: Screw connection
1808845	MSTBC 2,5/ 5-ST-5,08	Plug component, nominal current: 12 A, rated voltage: 320 V, pitch: 5.08 mm, no. of positions: 5, type of connection: Crimp connection
1809530	MSTBC 2,5/ 5-STZ-5,08	Plug component, nominal current: 12 A, rated voltage: 320 V, pitch: 5.08 mm, no. of positions: 5, type of connection: Crimp connection
1769049	MSTBP 2,5/ 5-ST-5,08	Plug, nominal current: 12 A, rated voltage: 250 V, pitch: 5,08 mm, no. of positions: 5, type of connection: Screw connection
1781014	MSTBT 2,5/ 5-ST-5,08	Plug, nominal current: 12 A, rated voltage: 250 V, pitch: 5,08 mm, no. of positions: 5, type of connection: Screw connection
1824382	MSTBU 2,5/ 5-ST-5,08-FL	Plug with T-shape and screw flange, nominal current: 12 A, rated voltage: 250 V, pitch: 5.08 mm, no. of positions: 5, type of connection: screw connection
1824159	MSTBU 2,5/ 5-STD-5,08	Plug component, nominal current: 12 A, rated voltage: 320 V, pitch: 5.08 mm, no. of positions: 5, type of connection: Screw connection
1831346	MSTBVK 2,5/ 5-ST-5,08	Plug component, nominal current: 12 A, rated voltage: 320 V, pitch: 5.08 mm, no. of positions: 5, type of connection: Screw connection
1792278	MVSTBR 2,5/ 5-ST-5,08	Plug, nominal current: 12 A, rated voltage: 250 V, pitch: 5,08 mm, no. of positions: 5, type of connection: Screw connection
1792786	MVSTBW 2,5/ 5-ST-5,08	Plug, nominal current: 12 A, rated voltage: 250 V, pitch: 5,08 mm, no. of positions: 5, type of connection: Screw connection
1917930	QC 0,75/ 5-ST-5,08	Plug components, 5.08 mm pitch, color: green, no. of positions 5, dimension a 20.32 mm

MSTBA 2,5/ 5-G-5,08



1883284	QC 1/ 5-ST-5,08	Plug component, nominal current: 10 A, rated voltage: 250 V, pitch: 5.08 mm, no. of positions: 5, type of connection: Insulation displacement connection QUICKON
1826319	SMSTB 2,5/ 5-ST-5,08	Plug, nominal current: 12 A, rated voltage: 250 V, pitch: 5,08 mm, no. of positions: 5, type of connection: Screw connection
1853049	TMSTBP 2,5/ 5-ST-5,08	Plug with screw flange, nominal current: 12 A, rated voltage: 250 V, pitch: 5,08 mm, no. of positions: 5, type of connection: Screw connection
1833849	UMSTBVK 2,5/ 5-ST-5,08	Plug component, nominal current: 12 A, rated voltage: 320 V, pitch: 5.08 mm, no. of positions: 5, type of connection: Screw connection

► Address

PHOENIX CONTACT GmbH & Co. KG
Flachsmarktstr. 8
32825 Blomberg
Germany
Phone +49 5235 3 00
Fax +49 5235 3 1200
<http://www.phoenixcontact.com>
Phoenix Contact
Technical modifications reserved;