

### Features

- Epitaxial Planar Die Construction
- Complementary PNP Types Available (DDTA)
- Built-In Biasing Resistors, R1 = R2
- **Lead Free/RoHS Compliant (Note 1)**
- **"Green" Device (Note 3 and 4)**

### Mechanical Data

- Case: SOT-523
- Case Material: Molded Plastic. UL Flammability Classification Rating 94V-0
- Moisture sensitivity: Level 1 per J-STD-020C
- Terminal Connections: See Diagram
- Terminals: Finish - Solderable per MIL-STD-202, Method 208
- Lead Free Plating (Matte Tin Finish annealed over Alloy 42 leadframe).
- Marking Information: See Table Below and Page 7
- Ordering Information: See Page 7
- Weight: 0.002 grams (approximate)

P/N	R1, RN (NOM)	Marking
DDTC123EE	2.2K $\Omega$	N04
DDTC143EE	4.7K $\Omega$	N08
DDTC114EE	10K $\Omega$	N13
DDTC124EE	22K $\Omega$	N17
DDTC144EE	47K $\Omega$	N20
DDTC115EE	100K $\Omega$	N24

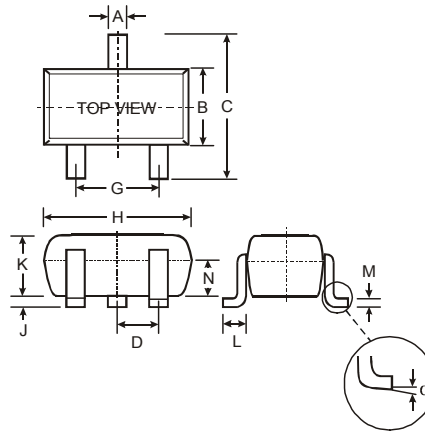

SOT-523			
Dim	Min	Max	Typ
A	0.15	0.30	0.22
B	0.75	0.85	0.80
C	1.45	1.75	1.60
D	—	—	0.50
G	0.90	1.10	1.00
H	1.50	1.70	1.60
J	0.00	0.10	0.05
K	0.60	0.80	0.75
L	0.10	0.30	0.22
M	0.10	0.20	0.12
N	0.45	0.65	0.50
$\alpha$	0°	8°	—
All Dimensions in mm			

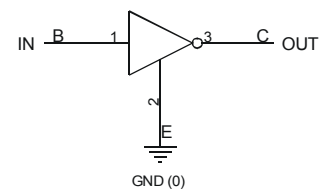
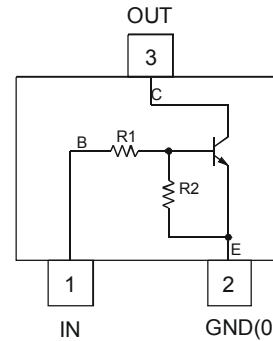

Schematic and Pin Configuration

Equivalent Inverter Circuit

### Maximum Ratings @T<sub>A</sub> = 25°C unless otherwise specified

Characteristic	Symbol	Value	Unit
Supply Voltage (3) to (2)	V <sub>CC</sub>	50	V
Input Voltage (1) to (2)	V <sub>IN</sub>	-10 to +12 -10 to +30 -10 to +40 -10 to +40 -10 to +40 -10 to +40	V
Output Current	I <sub>O</sub>	100 100 50 30 100 20	mA
Power Dissipation	P <sub>d</sub>	150	mW
Thermal Resistance, Junction to Ambient Air (Note 2)	R <sub>θJA</sub>	833	°C/W
Operating and Storage Temperature Range	T <sub>i</sub> , T <sub>STG</sub>	-55 to +150	°C

- Notes:
1. No purposefully added lead.
  2. Mounted on FR4 PC Board with recommended pad layout at <http://www.diodes.com/datasheets/ap02001.pdf>.
  3. Diodes Inc.'s "Green" policy can be found on our website at [http://www.diodes.com/products/lead\\_free/index.php](http://www.diodes.com/products/lead_free/index.php).
  4. Product manufactured with Date Code UO (week 40, 2007) and newer are built with Green Molding Compound. Product manufactured prior to Date Code UO are built with Non-Green Molding Compound and may contain Halogens or Sb2O3 Fire Retardants.

## Electrical Characteristics @T<sub>A</sub> = 25°C unless otherwise specified

Characteristic		Symbol	Min	Typ	Max	Unit	Test Condition
Input Voltage		V <sub>I(off)</sub>	0.5	1.1	—	V	V <sub>CC</sub> = 5V, I <sub>O</sub> = 100mA
		V <sub>I(on)</sub>	—	1.9	3		V <sub>O</sub> = 0.3V, I <sub>O</sub> = 20mA, DDTC123EE V <sub>O</sub> = 0.3V, I <sub>O</sub> = 20mA, DDTC143EE V <sub>O</sub> = 0.3V, I <sub>O</sub> = 10mA, DDTC114EE V <sub>O</sub> = 0.3V, I <sub>O</sub> = 5mA, DDTC124EE V <sub>O</sub> = 0.3V, I <sub>O</sub> = 2mA, DDTC144EE V <sub>O</sub> = 0.3V, I <sub>O</sub> = 1mA, DDTC115EE
Output Voltage		V <sub>O(on)</sub>	—	0.1	0.3	V	I <sub>O</sub> /I <sub>I</sub> = 10mA/0.5mA, DDTC123EE I <sub>O</sub> /I <sub>I</sub> = 10mA/0.5mA, DDTC143EE I <sub>O</sub> /I <sub>I</sub> = 10mA/0.5mA, DDTC114EE I <sub>O</sub> /I <sub>I</sub> = 10mA/0.5mA, DDTC124EE I <sub>O</sub> /I <sub>I</sub> = 10mA/0.5mA, DDTC144EE I <sub>O</sub> /I <sub>I</sub> = 5mA/0.25mA, DDTC115EE
Input Current	DDTC123EE DDTC143EE DDTC114EE DDTC124EE DDTC144EE DDTC115EE	I <sub>I</sub>	—	—	3.8 □ 1.8 □ 0.88 □ 0.36 □ 0.18 □ 0.15 □	mA	V <sub>I</sub> = 5V
Output Current		I <sub>O(off)</sub>	—	—	0.5	μA	V <sub>CC</sub> = 50V, V <sub>I</sub> = 0V
DC Current Gain	DDTC123EE DDTC143EE DDTC114EE DDTC124EE DDTC144EE DDTC115EE	G <sub>I</sub>	20 20 30 56 68 82	—	—	—	V <sub>O</sub> = 5V, I <sub>O</sub> = 20mA V <sub>O</sub> = 5V, I <sub>O</sub> = 10mA V <sub>O</sub> = 5V, I <sub>O</sub> = 5mA V <sub>O</sub> = 5V, I <sub>O</sub> = 5mA V <sub>O</sub> = 5V, I <sub>O</sub> = 5mA V <sub>O</sub> = 5V, I <sub>O</sub> = 5mA
Input Resistor (R <sub>1</sub> ) Tolerance		ΔR <sub>1</sub>	-30	—	+30	%	—
Resistance Ratio		R <sub>2</sub> /R <sub>1</sub>	0.8	1	1.2	—	—
Gain-Bandwidth Product*		f <sub>T</sub>	—	250	—	MHz	V <sub>CE</sub> = 10V, I <sub>E</sub> = 5mA, f = 100MHz

\* Transistor – For Reference Only

## Electrical Characteristics @T<sub>A</sub> = 25°C unless otherwise specified

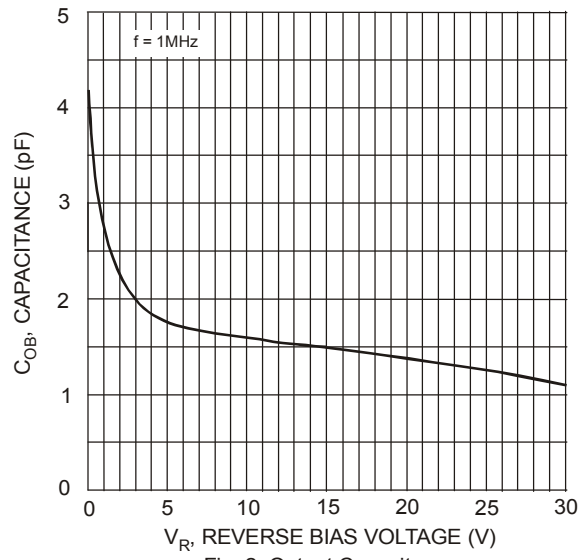
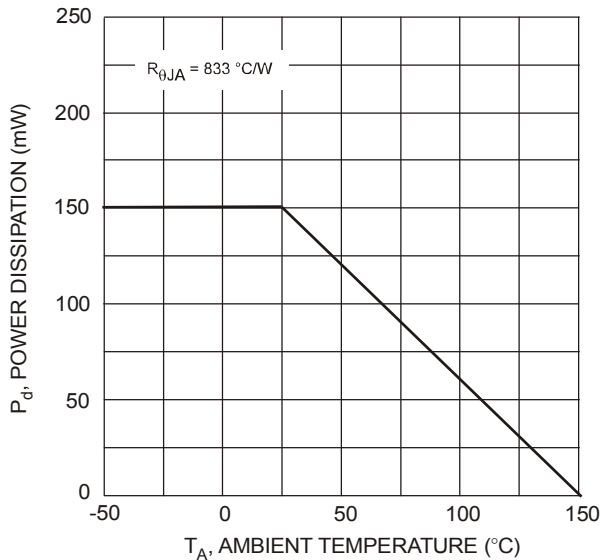

**Typical Curves – DDTC123EE**

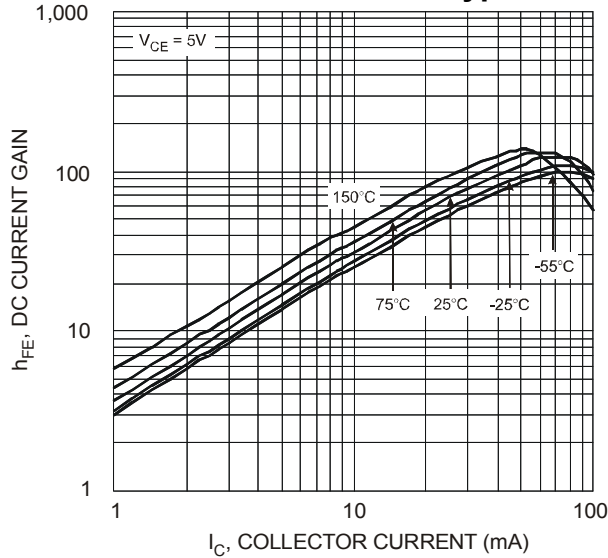

Fig. 3 Typical DC Current Gain vs. Collector Current

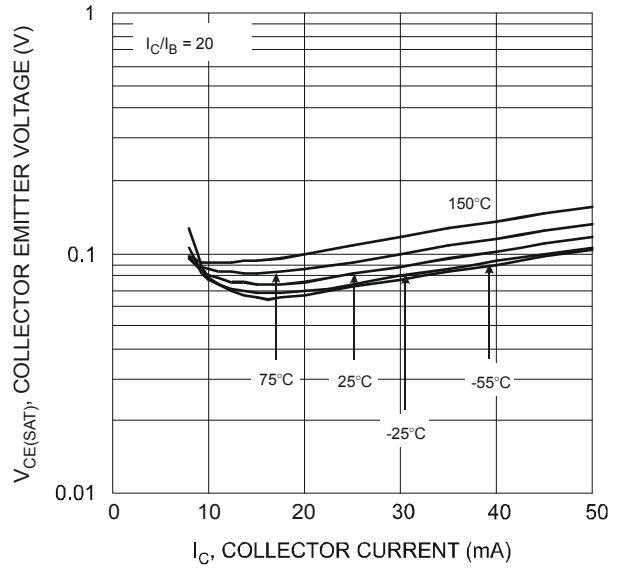

Fig. 4  $V_{CE(SAT)}$  vs.  $I_C$

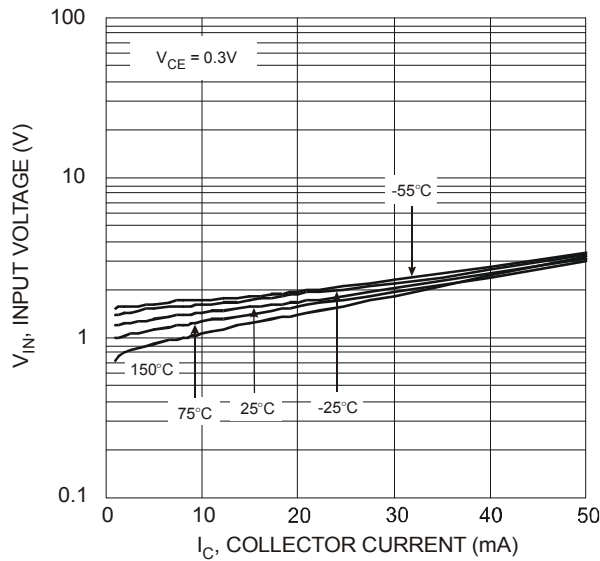

Fig. 5 Input Voltage vs. Collector Current

**Typical Curves – DDTC143EE**

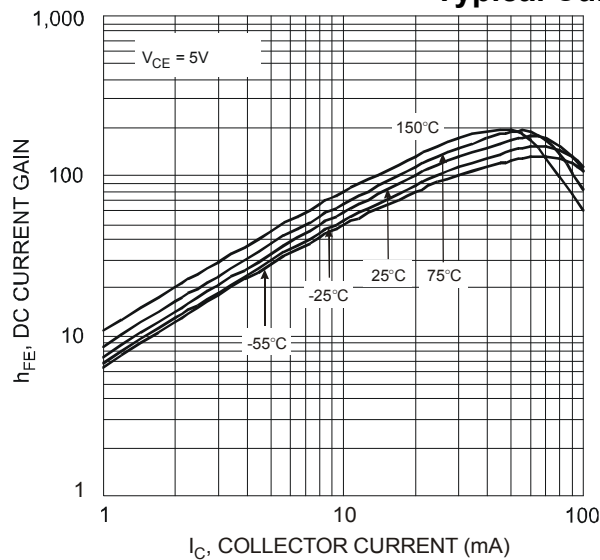

Fig. 6 Typical DC Current Gain vs. Collector Current

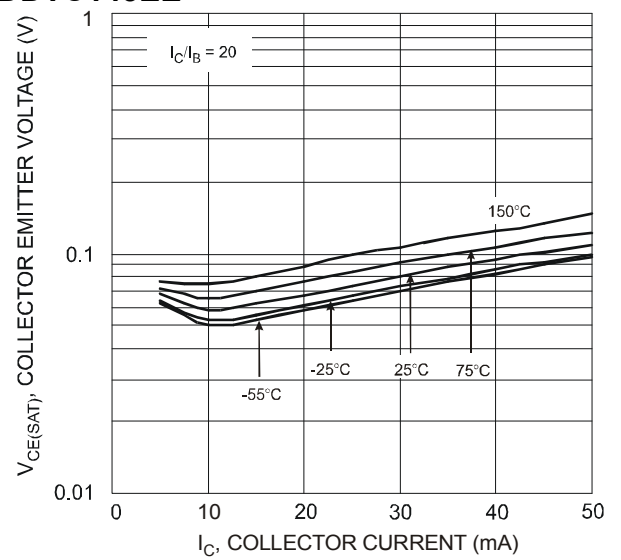

Fig. 7  $V_{CE(SAT)}$  vs.  $I_C$

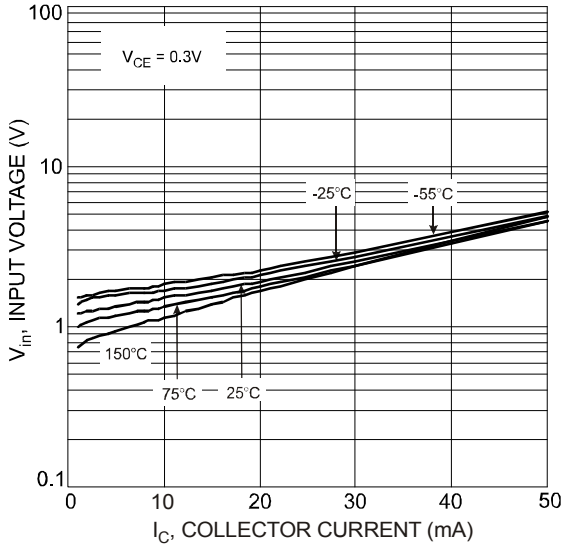

Fig. 8 Input Voltage vs. Collector Current

**Typical Curves – DDTC114EE**

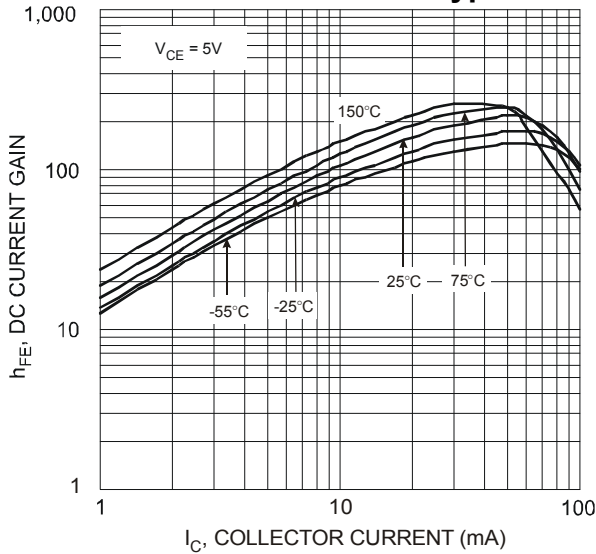

Fig. 9 Typical DC Current Gain vs. Collector Current

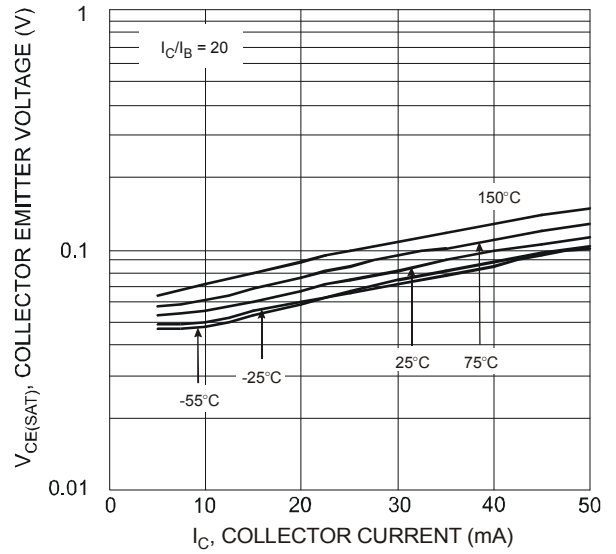

Fig. 10  $V_{CE(SAT)}$  vs.  $I_C$

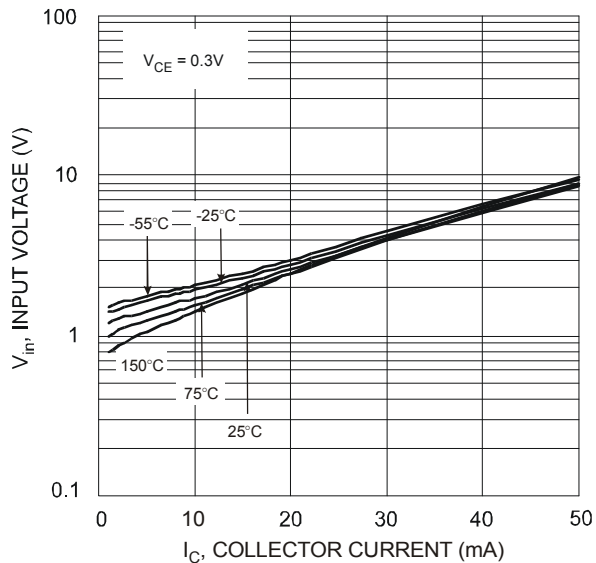

Fig. 11 Input Voltage vs. Collector Current

**Typical Curves – DDTC124EE**

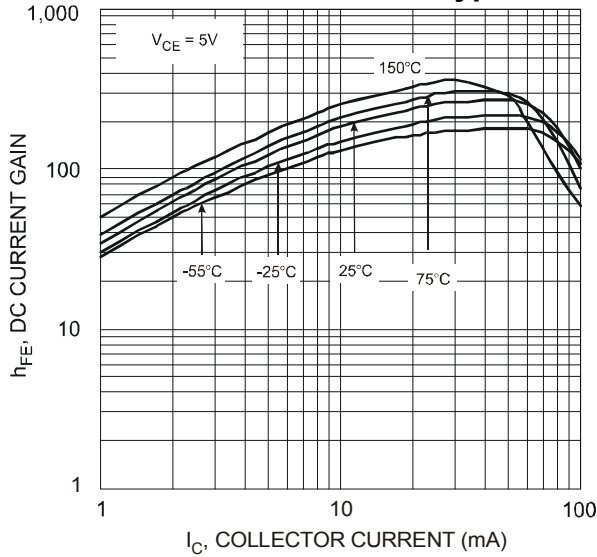

Fig. 12 Typical DC Current Gain vs. Collector Current

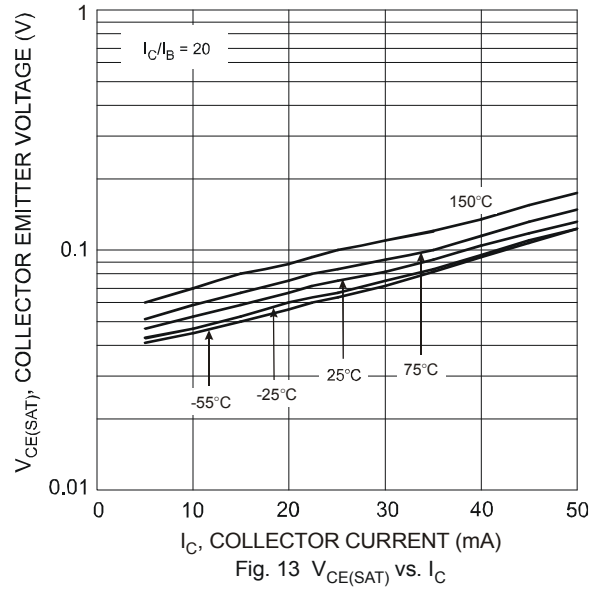

Fig. 13  $V_{CE(SAT)}$  vs.  $I_C$

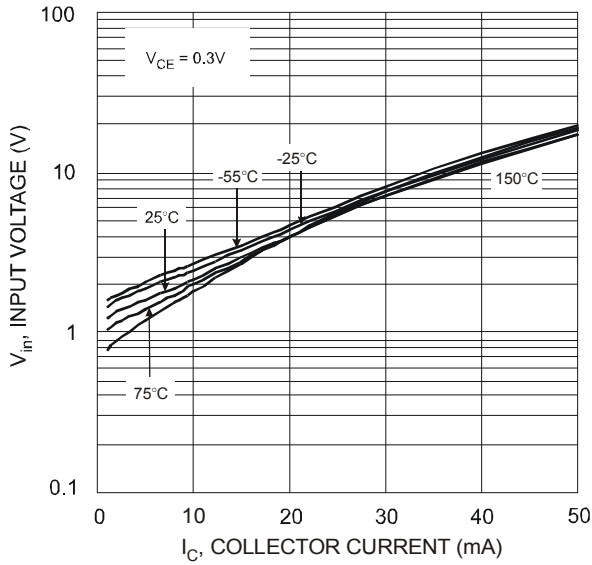

Fig. 14 Input Voltage vs. Collector Current

**Typical Curves – DDTC144EE**

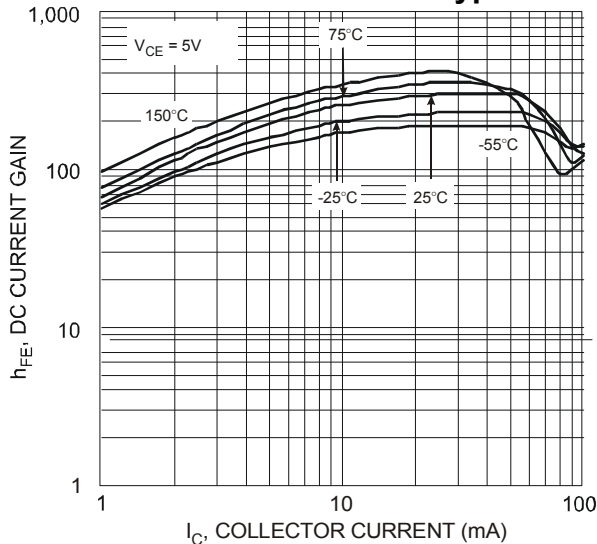

Fig. 15 Typical DC Current Gain vs. Collector Current

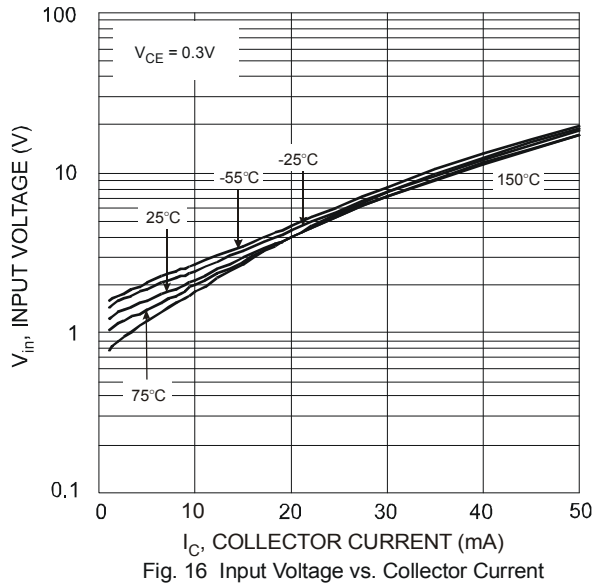

Fig. 16 Input Voltage vs. Collector Current

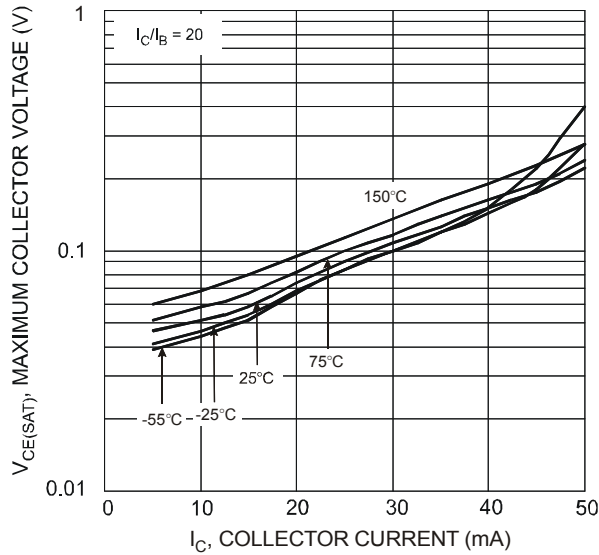

Fig. 17  $V_{CE(SAT)}$  vs.  $I_C$

## Ordering Information (Note 5)

Device	Packaging	Shipping
DDTC123EE-7-F	SOT-523	3000/Tape & Reel
DDTC143EE-7-F	SOT-523	3000/Tape & Reel
DDTC114EE-7-F	SOT-523	3000/Tape & Reel
DDTC124EE-7-F	SOT-523	3000/Tape & Reel
DDTC144EE-7-F	SOT-523	3000/Tape & Reel
DDTC115EE-7-F	SOT-523	3000/Tape & Reel

Notes: 5. For packaging details, go to our website at <http://www.diodes.com/datasheets/ap02007.pdf>.

## Marking Information

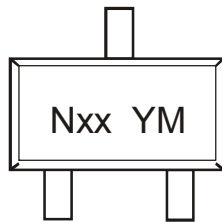

Nxx = Product Type Marking Code (See Page 1)  
 YM = Date Code Marking  
 Y = Year ex: T = 2006  
 M = Month ex: 9 = September

### Date Code Key

Year	2002	2003	2004	2005	2006	2007	2008	2009	2010	2011	2012
Code	N	P	R	S	T	U	V	W	X	Y	Z

Month	Jan	Feb	Mar	Apr	May	Jun	Jul	Aug	Sep	Oct	Nov	Dec
Code	1	2	3	4	5	6	7	8	9	O	N	D

### IMPORTANT NOTICE

Diodes Incorporated and its subsidiaries reserve the right to make modifications, enhancements, improvements, corrections or other changes without further notice to any product herein. Diodes Incorporated does not assume any liability arising out of the application or use of any product described herein; neither does it convey any license under its patent rights, nor the rights of others. The user of products in such applications shall assume all risks of such use and will agree to hold Diodes Incorporated and all the companies whose products are represented on our website, harmless against all damages.

### LIFE SUPPORT

Diodes Incorporated products are not authorized for use as critical components in life support devices or systems without the expressed written approval of the President of Diodes Incorporated.