

BU323Z

NPN Silicon Power Darlington

High Voltage Autoprotected

The BU323Z is a planar, monolithic, high-voltage power Darlington with a built-in active zener clamping circuit. This device is specifically designed for unclamped, inductive applications such as Electronic Ignition, Switching Regulators and Motor Control, and exhibit the following main features:

- Integrated High-Voltage Active Clamp
- Tight Clamping Voltage Window (350 V to 450 V) Guaranteed Over the -40°C to +125°C Temperature Range
- Clamping Energy Capability 100% Tested in a Live Ignition Circuit
- High DC Current Gain/Low Saturation Voltages Specified Over Full Temperature Range
- Design Guarantees Operation in SOA at All Times
- Offered in Plastic SOT-93/TO-218 Type or TO-220 Packages
- Pb-Free Packages are Available*

MAXIMUM RATINGS

Rating	Symbol	Max	Unit
Collector-Emitter Sustaining Voltage	V_{CEO}	350	Vdc
Collector-Emitter Voltage	V_{EBO}	6.0	Vdc
Collector Current – Continuous	I_C	10	Adc
– Peak	I_{CM}	20	
Base Current – Continuous	I_B	3.0	Adc
– Peak	I_{BM}	6.0	
Total Power Dissipation @ $T_C = 25^\circ\text{C}$ Derate above 25°C	P_D	150 1.0	W W/°C
Operating and Storage Junction Temperature Range	T_J, T_{stg}	-65 to +175	°C

THERMAL CHARACTERISTICS

Characteristic	Symbol	Max	Unit
Thermal Resistance, Junction-to-Case	$R_{\theta JC}$	1.0	°C/W
Maximum Lead Temperature for Soldering Purposes: 1/8" from Case for 5 Seconds	T_L	260	°C

Stresses exceeding Maximum Ratings may damage the device. Maximum Ratings are stress ratings only. Functional operation above the Recommended Operating Conditions is not implied. Extended exposure to stresses above the Recommended Operating Conditions may affect device reliability.

*For additional information on our Pb-Free strategy and soldering details, please download the ON Semiconductor Soldering and Mounting Techniques Reference Manual, SOLDERRM/D.



ON Semiconductor®

<http://onsemi.com>

**10 AMPERE DARLINGTON
AUTOPROTECTED
360 – 450 VOLTS CLAMP,
150 WATTS**

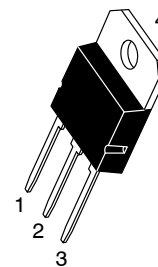
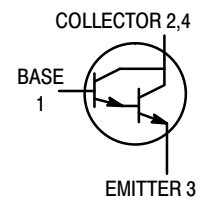
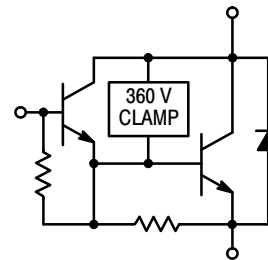

SOT-93
CASE 340D
STYLE 1

MARKING DIAGRAM

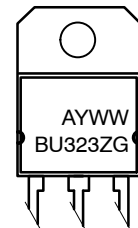

A = Assembly Location
Y = Year
WW = Work Week
G = Pb-Free Package
BU323Z = Device Code

ORDERING INFORMATION

Device	Package	Shipping
BU323Z	SOT-93	30 Units / Rail
BU323ZG	SOT-93 (Pb-Free)	30 Units / Rail

BU323Z

ELECTRICAL CHARACTERISTICS (T_C = 25°C unless otherwise noted)

Characteristic	Symbol	Min	Typ	Max	Unit
OFF CHARACTERISTICS (1)					
Collector–Emitter Clamping Voltage (I _C = 7.0 A) (T _C = –40°C to +125°C)	V _{CLAMP}	350	—	450	Vdc
Collector–Emitter Cutoff Current (V _{CE} = 200 V, I _B = 0)	I _{CEO}	—	—	100	μAdc
Emitter–Base Leakage Current (V _{EB} = 6.0 Vdc, I _C = 0)	I _{EBO}	—	—	50	mAdc

ON CHARACTERISTICS (1)

Base–Emitter Saturation Voltage (I _C = 8.0 Adc, I _B = 100 mAdc) (I _C = 10 Adc, I _B = 0.25 Adc)	V _{BE(sat)}	— —	— —	2.2 2.5	Vdc
Collector–Emitter Saturation Voltage (I _C = 7.0 Adc, I _B = 70 mAdc) (I _C = 8.0 Adc, I _B = 0.1 Adc) (I _C = 10 Adc, I _B = 0.25 Adc)	V _{CE(sat)}	— — —	— — —	1.6 1.8 1.8 2.1 1.7	Vdc
Base–Emitter On Voltage (I _C = 5.0 Adc, V _{CE} = 2.0 Vdc) (I _C = 8.0 Adc, V _{CE} = 2.0 Vdc)	V _{BE(on)}	1.1 1.3	— —	2.1 2.3	Vdc
Diode Forward Voltage Drop (I _F = 10 Adc)	V _F	—	—	2.5	Vdc
DC Current Gain (I _C = 6.5 Adc, V _{CE} = 1.5 Vdc) (I _C = 5.0 Adc, V _{CE} = 4.6 Vdc)	h _{FE}	150 500	— —	— 3400	—

DYNAMIC CHARACTERISTICS

Current Gain Bandwidth (I _C = 0.2 Adc, V _{CE} = 10 Vdc, f = 1.0 MHz)	f _T	—	—	2.0	MHz
Output Capacitance (V _{CB} = 10 Vdc, I _E = 0, f = 1.0 MHz)	C _{ob}	—	—	200	pF
Input Capacitance (V _{EB} = 6.0 V)	C _{ib}	—	—	550	pF

CLAMPING ENERGY (see notes)

Repetitive Non–Destructive Energy Dissipated at turn–off: (I _C = 7.0 A, L = 8.0 mH, R _{BE} = 100 Ω) (see Figures 2 and 4)	W _{CLAMP}	200	—	—	mJ
--	--------------------	-----	---	---	----

SWITCHING CHARACTERISTICS: Inductive Load (L = 10 mH)

Fall Time	(I _C = 6.5 A, I _{B1} = 45 mA, V _{BE(off)} = 0, R _{BE(off)} = 0, V _{CC} = 14 V, V _Z = 300 V)	t _{fi}	—	625	—	ns
Storage Time		t _{si}	—	10	30	μs
Cross–over Time		t _c	—	1.7	—	μs

(1) Pulse Test: Pulse Width ≤ 300 μs, Duty Cycle = 2.0%.

BU323Z

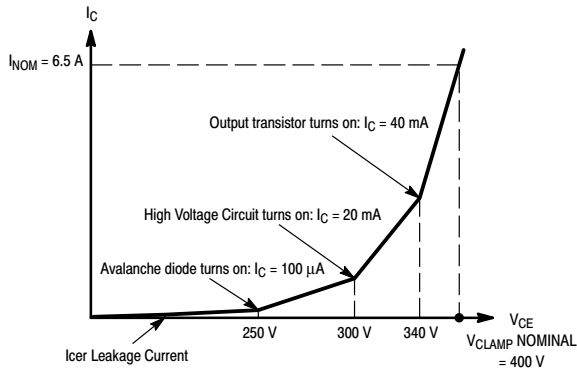

Figure 1. $I_C = f(V_{CE})$ Curve Shape

By design, the BU323Z has a built-in avalanche diode and a special high voltage driving circuit. During an auto-protect cycle, the transistor is turned on again as soon as a voltage, determined by the zener threshold and the network, is reached. This prevents the transistor from going into a Reverse Bias Operating limit condition. Therefore, the device will have an extended safe operating area and will always appear to be in "FBSOA." Because of the built-in zener and associated network, the $I_C = f(V_{CE})$ curve exhibits an unfamiliar shape compared to standard products as shown in Figure 1.

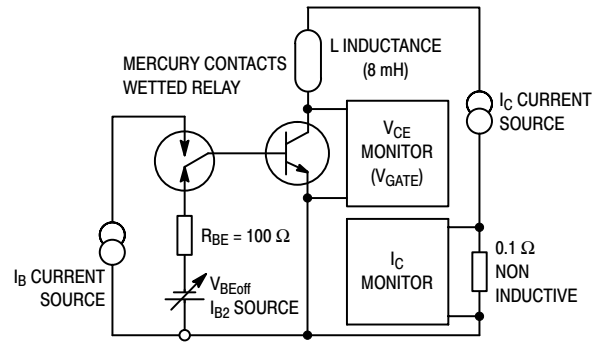

Figure 2. Basic Energy Test Circuit

The bias parameters, V_{CLAMP} , I_{B1} , $V_{BE(off)}$, I_{B2} , I_C , and the inductance, are applied according to the Device Under Test (DUT) specifications. V_{CE} and I_C are monitored by the test system while making sure the load line remains within the limits as described in Figure 4.

Note: All BU323Z ignition devices are 100% energy tested, per the test circuit and criteria described in Figures 2 and 4, to the minimum guaranteed repetitive energy, as specified in the device parameter section. The device can sustain this energy on a repetitive basis without degrading any of the specified electrical characteristics of the devices. The units under test are kept functional during the complete test sequence for the test conditions described:

$I_{C(peak)} = 7.0 \text{ A}$, $I_{CH} = 5.0 \text{ A}$, $I_{CL} = 100 \text{ mA}$, $I_B = 100 \text{ mA}$, $R_{BE} = 100 \text{ } \Omega$, $V_{gate} = 280 \text{ V}$, $L = 8.0 \text{ mH}$

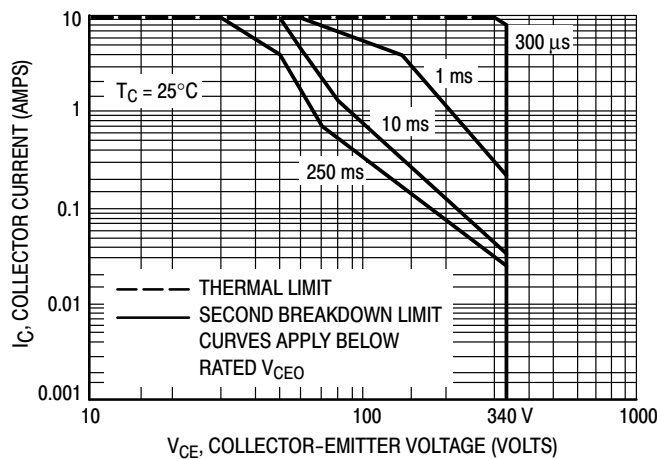
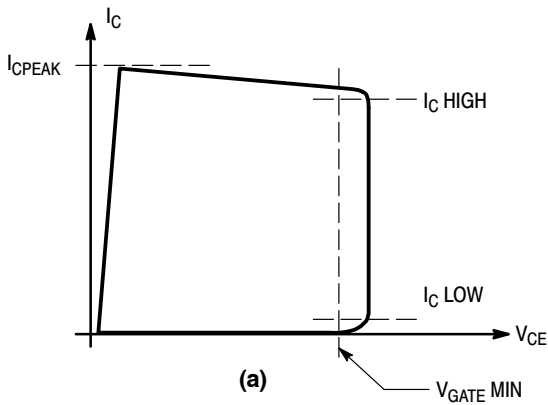
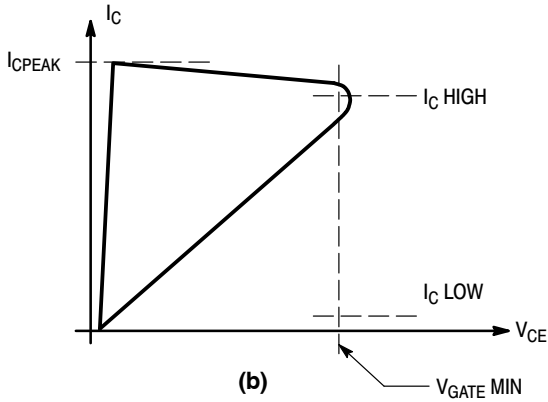

Figure 3. Forward Bias Safe Operating Area



The shaded area represents the amount of energy the device can sustain, under given DC biases ($I_C/I_B/V_{BE(off)}/R_{BE}$), without an external clamp; see the test schematic diagram, Figure 2.

The transistor **PASSES** the Energy test if, for the inductive load and $I_{CPEAK}/I_B/V_{BE(off)}$ biases, the V_{CE} remains outside the shaded area and greater than the V_{GATE} minimum limit, Figure 4a.



The transistor **FAILS** if the V_{CE} is less than the V_{GATE} (minimum limit) at any point along the V_{CE}/I_C curve as shown on Figures 4b, and 4c. This assures that hot spots and uncontrolled avalanche are not being generated in the die, and the transistor is not damaged, thus enabling the sustained energy level required.

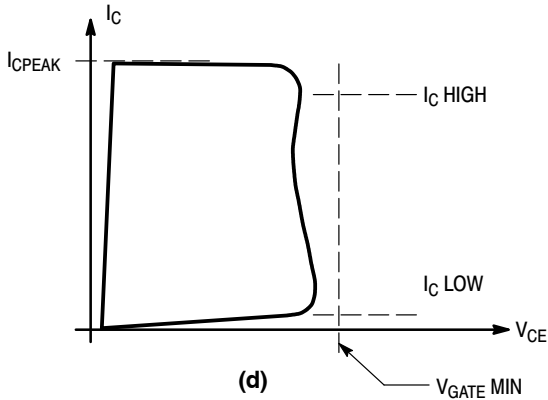
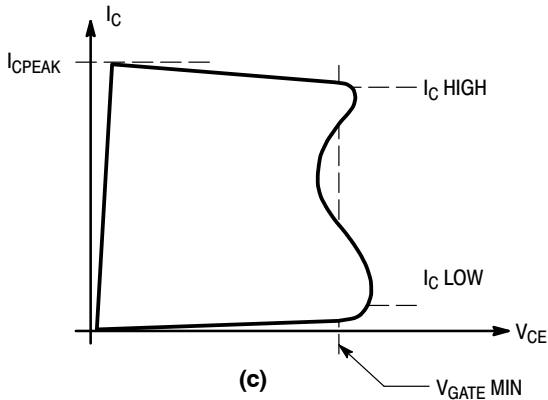

The transistor **FAILS** if its Collector/Emitter breakdown voltage is less than the V_{GATE} value, Figure 4d.

Figure 4. Energy Test Criteria for BU323Z

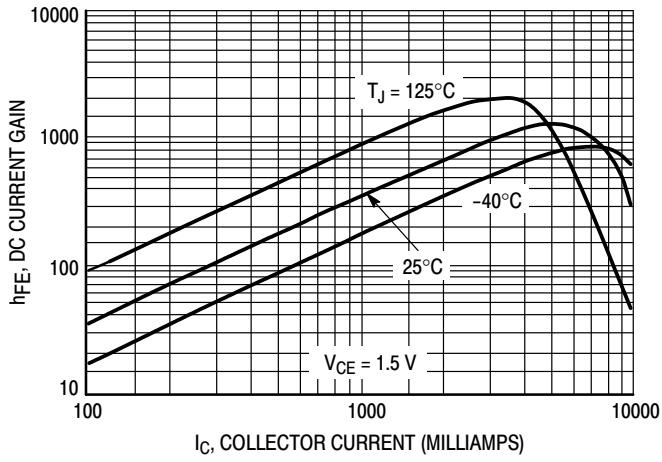

Figure 5. DC Current Gain

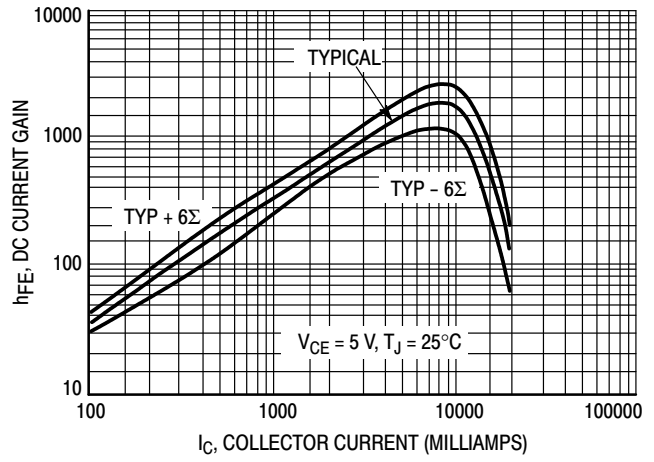

Figure 6. DC Current Gain

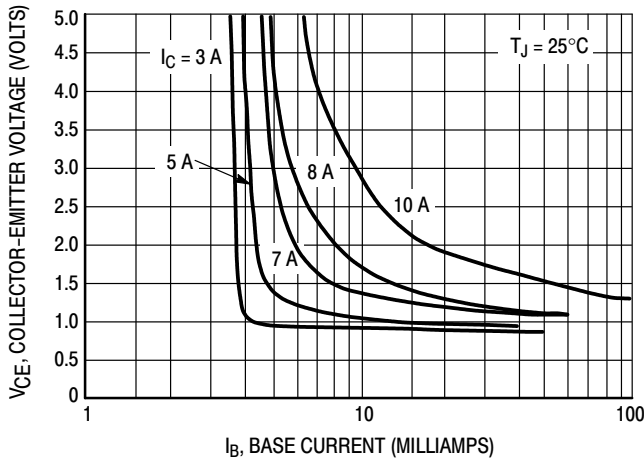

Figure 7. Collector Saturation Region

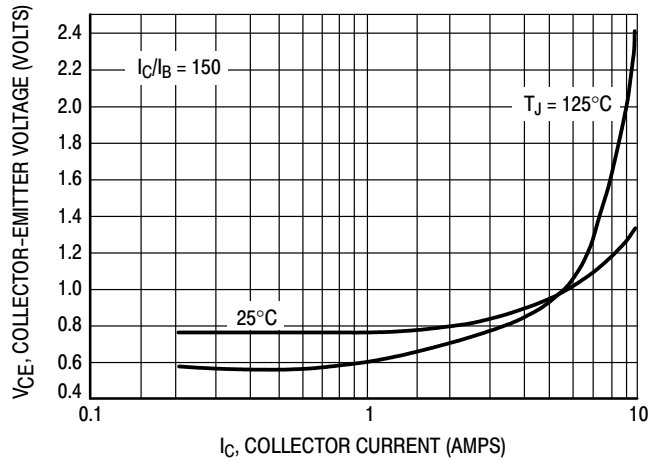

Figure 8. Collector-Emitter Saturation Voltage

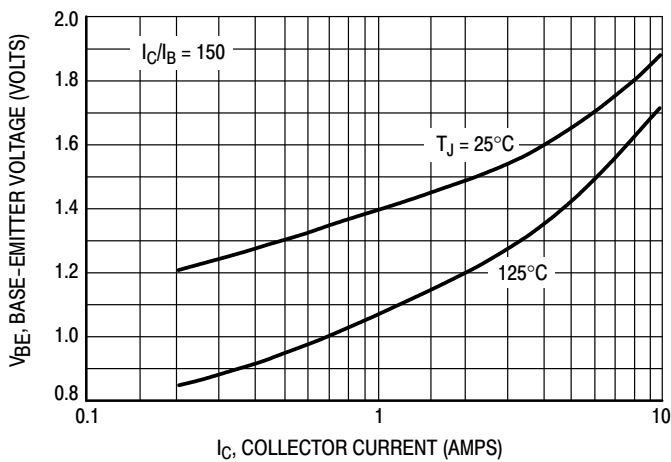

Figure 9. Base-Emitter Saturation Voltage

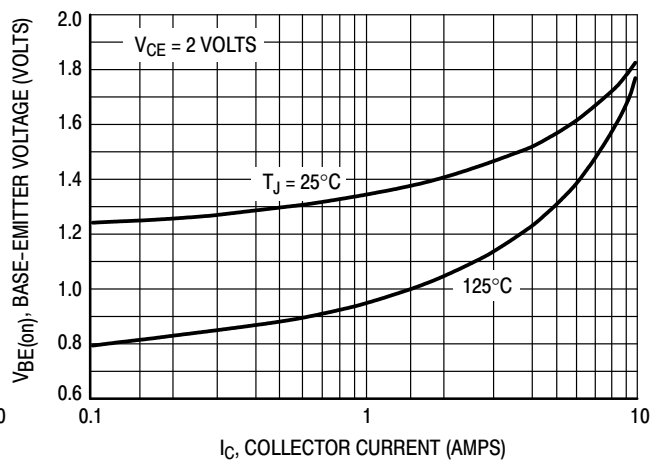
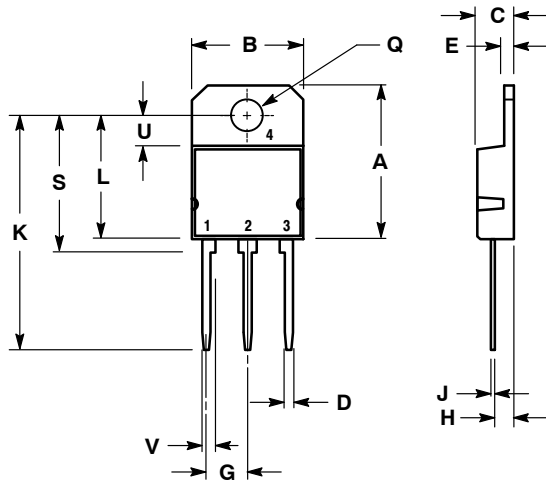

Figure 10. Base-Emitter "ON" Voltages

BU323Z

PACKAGE DIMENSIONS

SOT-93 (TO-218) CASE 340D-02 ISSUE E



- NOTES:
1. DIMENSIONING AND TOLERANCING PER ANSI Y14.5M, 1982.
2. CONTROLLING DIMENSION: MILLIMETER.

DIM	MILLIMETERS		INCHES	
	MIN	MAX	MIN	MAX
A	---	20.35	---	0.801
B	14.70	15.20	0.579	0.598
C	4.70	4.90	0.185	0.193
D	1.10	1.30	0.043	0.051
E	1.17	1.37	0.046	0.054
G	5.40	5.55	0.213	0.219
H	2.00	3.00	0.079	0.118
J	0.50	0.78	0.020	0.031
K	31.00 REF		1.220 REF	
L	---	16.20	---	0.638
Q	4.00	4.10	0.158	0.161
S	17.80	18.20	0.701	0.717
U	4.00 REF		0.157 REF	
V	1.75 REF		0.069	

- STYLE 1:
PIN 1. BASE
2. COLLECTOR
3. EMITTER
4. COLLECTOR

ON Semiconductor and  are registered trademarks of Semiconductor Components Industries, LLC (SCILLC). SCILLC reserves the right to make changes without further notice to any products herein. SCILLC makes no warranty, representation or guarantee regarding the suitability of its products for any particular purpose, nor does SCILLC assume any liability arising out of the application or use of any product or circuit, and specifically disclaims any and all liability, including without limitation special, consequential or incidental damages. "Typical" parameters which may be provided in SCILLC data sheets and/or specifications can and do vary in different applications and actual performance may vary over time. All operating parameters, including "Typicals" must be validated for each customer application by customer's technical experts. SCILLC does not convey any license under its patent rights nor the rights of others. SCILLC products are not designed, intended, or authorized for use as components in systems intended for surgical implant into the body, or other applications intended to support or sustain life, or for any other application in which the failure of the SCILLC product could create a situation where personal injury or death may occur. Should Buyer purchase or use SCILLC products for any such unintended or unauthorized application, Buyer shall indemnify and hold SCILLC and its officers, employees, subsidiaries, affiliates, and distributors harmless against all claims, costs, damages, and expenses, and reasonable attorney fees arising out of, directly or indirectly, any claim of personal injury or death associated with such unintended or unauthorized use, even if such claim alleges that SCILLC was negligent regarding the design or manufacture of the part. SCILLC is an Equal Opportunity/Affirmative Action Employer. This literature is subject to all applicable copyright laws and is not for resale in any manner.

PUBLICATION ORDERING INFORMATION

LITERATURE FULFILLMENT:
Literature Distribution Center for ON Semiconductor
P.O. Box 5163, Denver, Colorado 80217 USA
Phone: 303-675-2175 or 800-344-3860 Toll Free USA/Canada
Fax: 303-675-2176 or 800-344-3867 Toll Free USA/Canada
Email: orderlit@onsemi.com

N. American Technical Support: 800-282-9855 Toll Free
USA/Canada
Europe, Middle East and Africa Technical Support:
Phone: 421 33 790 2910
Japan Customer Focus Center
Phone: 81-3-5773-3850

ON Semiconductor Website: www.onsemi.com
Order Literature: <http://www.onsemi.com/orderlit>
For additional information, please contact your local Sales Representative

BU323Z/D